

vestre

Munch

Article no:5116

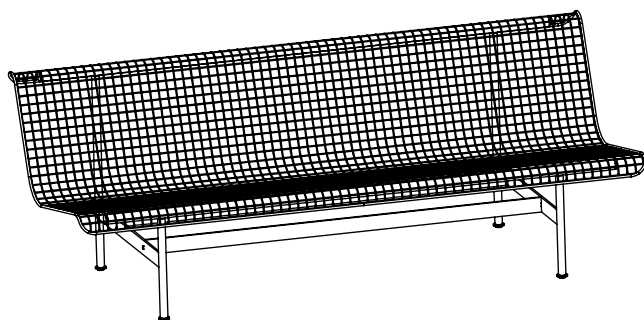

39 Kg

