

vestre

# Stones

Planter

Article no: 5280, 5280C ,5282, 5282C

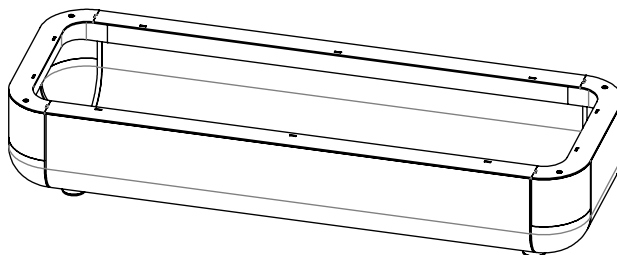

118 kg

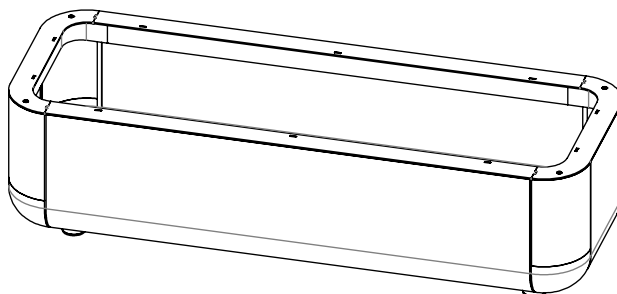

136 kg

5280

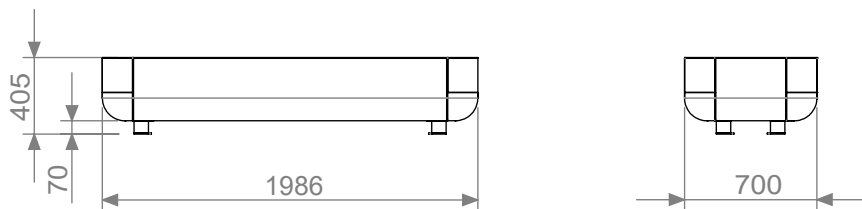

5282

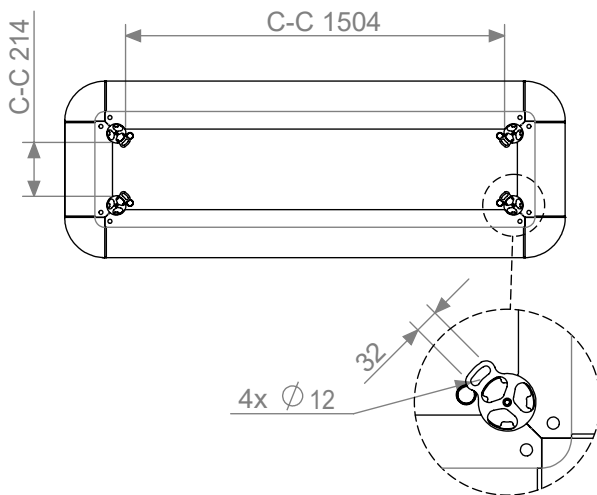
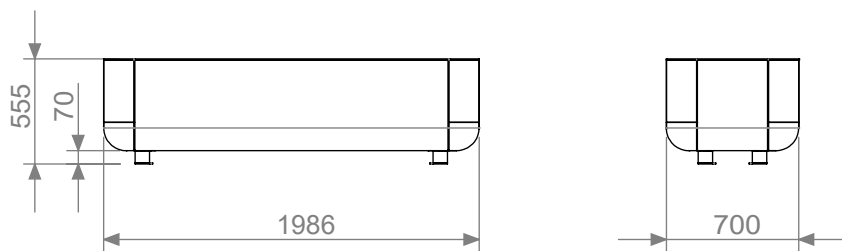

5280C

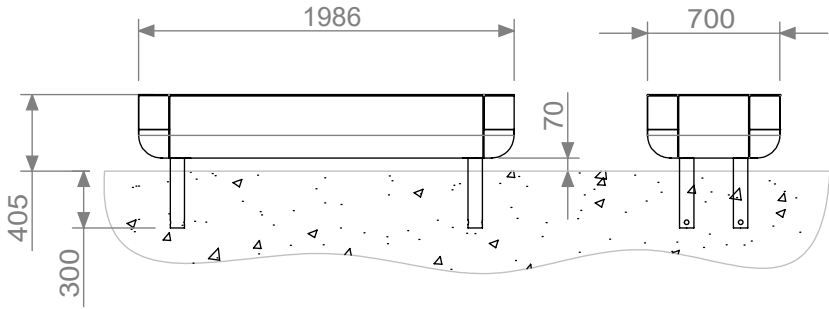

5282C

