

# re- connect

---

Oslo  
Stavanger  
Milan  
Albertville  
Atlanta  
Austin  
Brooklyn  
Dallas  
Los Angeles  
New York  
Oakland  
Seattle  
Washington D.C.  
Bremen  
Dorsten  
Schwarzenbeck  
Staufenberg  
Stockholm  
Uppsala  
Brighton  
London  
Dublin



vestre

*In Scandinavia, the right to roam is so strong that the principle that outdoor space belongs to all of us is part of our national spirit. At Vestre, we believe that this idea should be expanded to include urban areas across the world.*

Hello from Vestre → **3**

Sustainability → **14**

Product overview → **22**

News → **42**

Vestre Habitats → **52**

Inspiration → **58**

About Vestre → **160**

Designers → **162**

Guarantees → **166**

Colours → **170**

The Plus → **172**

Price list → **176**





# At Vestre, we want to make the world a better place by creating social meeting places – neighbourhood by neighbourhood

We make colourful, sustainable and inclusive furniture which encourages people to get together, to care and to participate in everyday democracy. If you travel around Norway, you can find furniture we created back in the 50s. It is still standing, creating social meeting places every day of the year. This year, we have been especially concerned about people finding their way back. We hope we can both find our way back to each other and create a strong 'we', and that we can find our way back to nature and the fight for sustainability. This will also be the year that Vestre will open the doors—and the green roof—to the world's most environmentally friendly and transparent furniture factory: The Plus. It was designed by BIG Bjarke Ingels Group as a completely new kind of factory where people, production, technology, architecture and nature are completely integrated with each other. In the heart of the building, which is shaped like a plus sign, there is an atrium with a single tree. It is there as a symbol of the global community—as an axis mundi. We know that the global environmental crisis is being made worse by the fact that many people have lost contact with nature. Vestre's aim is to be recognised as the world's most sustainable furniture manufacturer. It's a bold aim which guides our culture and the way we do business. Every year, we at Vestre give 10% of our profit to initiatives across the world that support the UN's Sustainable Development Goals. With this inspiration book, we hope to tell you more about our vision and about how we are working to achieve it.

On behalf of everyone at Team Vestre:  
Thank you for putting your trust in us!

**vestre**

reconnect with  
nature



Product: Plinth  
Location:  
Durbach, Germany  
RAL: 6032

reconnect with  
family



Product: Bloc  
Location:  
Washington, D.C., USA  
RAL: 3020

reconnect with  
friends



Product: Bloc  
Location:  
Oslo, Norway  
RAL: 2000

reconnect with  
classmates



Product: Stripes  
Location:  
Oslo, Norway  
RAL: 1023

reconnect with  
colleagues



Product: Forum  
Location:  
Oslo, Norway  
RAL: 3014



Everyone can do  
their bit to save the  
world. Little by little.

At Vestre, we have incorporated nine of the UN's Sustainable Development Goals into our business philosophy, and our aim is to be recognised as the world's most sustainable furniture manufacturer. Although we will implement many measures ourselves, this is not enough. If the world is to succeed in eradicating poverty, fighting inequality and stopping climate change before 2030, a lot more will be needed. That's why, every year, Vestre gives at least 10% of our profits to sustainable projects around the world. If more companies followed suit, the business community could not only match the Norwegian aid budget, but more than double it. That says something about what we could achieve on a global scale. We encourage more people to share the cost and give their piece of the pie. That's why we've started the campaign Piece of the Pie Chart in order to inspire companies all over the world to give part of their profits to support the sustainability goals. *Join the fundraiser at [vestre.com/piece-of-the-pie-chart](https://vestre.com/piece-of-the-pie-chart).*



4

QUALITY  
EDUCATION



## Knowledge is power

Vestre supports Gyaw Gyaw's work to build schools in Myanmar, and UNICEF's work to give up to 3,500 children every year in conflict zones the opportunity to go to school. Together with the Oslo School of Architecture and Design and Norwegian Church Aid, we are developing a furniture design course in Jericho in the West Bank. In Scandinavia, we give out scholarships to recently graduated designers and collaborate with local vocational schools.

7

AFFORDABLE AND  
CLEAN ENERGY



## The future is electric

Vestre uses 100% renewable energy in its manufacturing processes. Most of this energy comes from clean hydropower. By 2025, we aim to be energy self-sufficient with renewable solar, wind and hydro power. On sunny days, our steel factory in Torsby already produces enough energy to power itself at 150,000 kWh a year. Our factory in Magnor, The Plus, will generate around 250,000 kWh of renewable energy per year, from more than 1,000 roof-top and ground-level solar panels. Surplus heat from production will heat the building. We also support SUNami's work to make everyday life easier for people in Kenya using solutions based on clean solar energy.

8

DECENT WORK AND  
ECONOMIC GROWTH



## Jobs for all

Vestre was the first furniture manufacturer to join Ethical Trade Norway nearly 15 years ago and we set strict requirements for all our subcontractors concerning human rights, labour rights and sustainable development. Because work is not just about income. It's about belonging, community and mastery. Vestre gives jobs to people with gaps in their CVs and poor access to normal working life. At our new factory The Plus, we have joined forces with regional vocational training institutions to create attractive apprenticeships and vocational training places for young people who have dropped out of ordinary upper secondary education. We also support the Church City Mission, which helps people struggling in their everyday lives.

Vestre supports Gyaw Gyaw's work in Myanmar to construct school buildings for existing schools and other educational institutions. With sustainable architecture as a guiding principle, they build schools using local and environmentally friendly materials that are adapted to the climate and landscape.



Collaborating with global organisations is sometimes the only way to reach people on the fringes of society. Vestre therefore supports the work done by Doctors Without Borders to reduce health disparities across the world, and to build field hospitals where hospital treatment is not available.

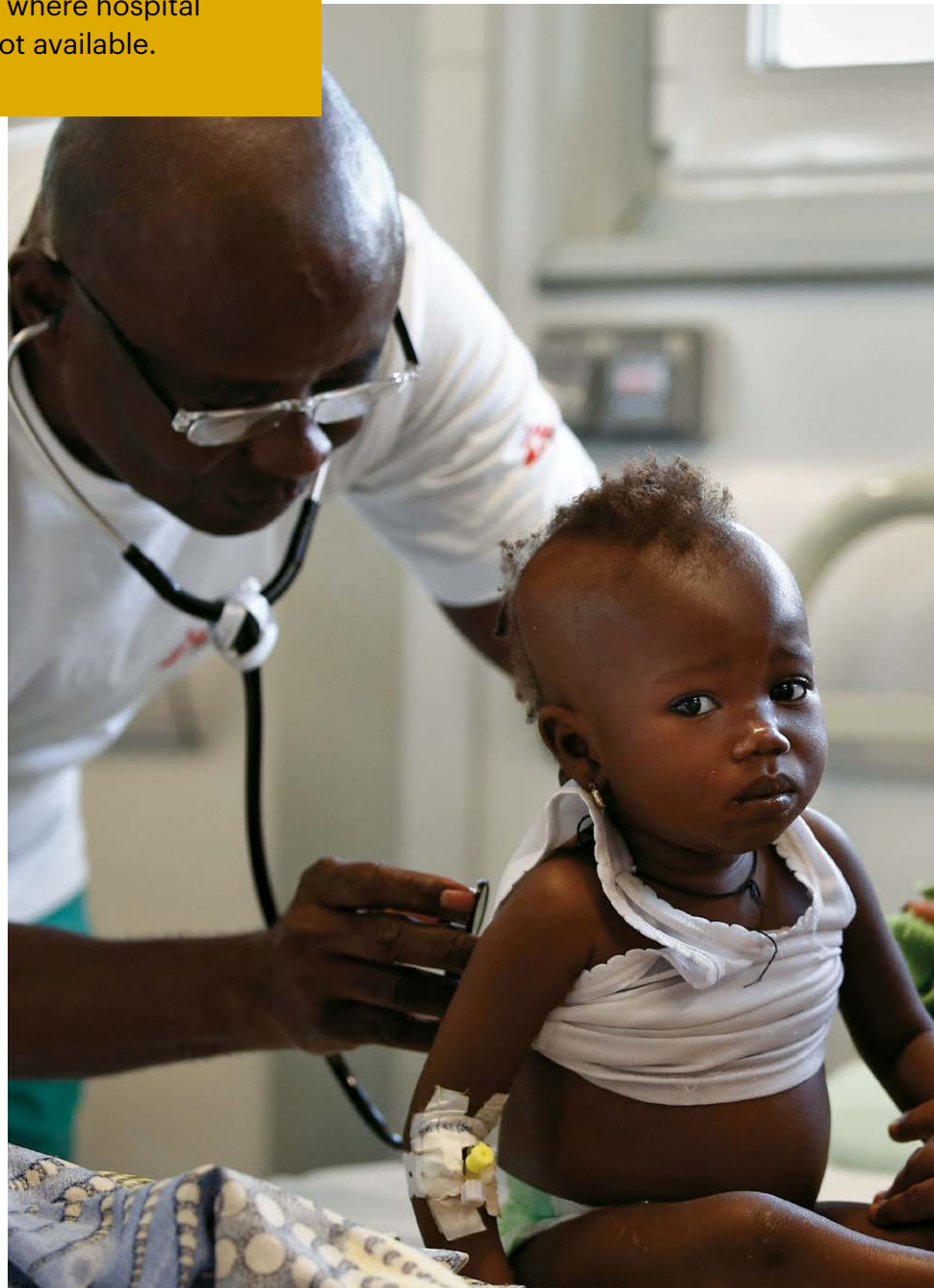

## Spearheading the green transition

Vestre consistently uses materials with the lowest possible emissions, even if it costs more. Examples of this are steel from SSAB, which has 30% lower emissions than the global average, and recycled aluminium from Norsk Hydro with up to eight times lower emissions. We are also in the process of electrifying all our internal goods transport. What's more, we recently began production at the world's most environmentally friendly furniture factory – The Plus – which sets a new standard for digitalisation and uses pioneering Industry 4.0 technology. Vestre has also continued to increase its engagement with Techbridge, an incubator for start-up companies in East Africa which has a particular focus on social and environmental impact.



## Less inequality creates more trust

We support work being carried out to reduce inequalities within and between countries. In all markets in which we have an active presence, we create secure jobs and contribute tax revenues. We refuse to supply hostile design, for example benches with spikes created to keep the most vulnerable people in society away from our shared outdoor spaces. We also support the work done by Doctors Without Borders to reduce health disparities across the world, and to build field hospitals where people do not have access to hospital treatment.



## Green cities are smart cities

Cities account for around 75% of all greenhouse gas emissions. Together with Young Sustainable Impact (YSI) and others, we are researching how major cities can become more energy-efficient through new mobility solutions, reusing surface water and providing more attractive outdoor areas. We offer litter bins that give alerts when they need to be emptied, and we are creating more and more products with charging options and wireless internet connectivity. Together with Chime, we are also working to extend microloans on crops. These can be paid back and used again to ensure economic growth and the creation of workplaces in low-income societies.



## Vestre Vision Zero

Our vision is to not make a single product that cannot last forever. This is possible with correct use and maintenance, along with a scheme where, after years of use, worn out furniture can be restored and reused. We don't cut corners. We provide a lifetime guarantee against rust and at least a 15-year guarantee on paint and wood. We supply spare parts with no time limit; our products have no expiration date. We also support Empower who work to reduce marine plastic pollution and increase employment in countries that need it. For example, people in Laos can earn microcredit by clearing ocean plastic so they can start their own companies, just like Johs. Vestre did in 1947.



## Zero emissions target

Man-made climate change is the biggest challenge of our age. There are solutions however, although we are running out of time. Our steel factory in Torsby has already been carbon-neutral for more than 10 years. While reducing our own emissions, we are a driving force behind speeding up the development of fossil-free steel and long-distance transport based on pure hydrogen, for example. We also help fund UN-approved environmental projects in other parts of the world, for example landfill facilities in Colombia and rainforest protection in Papua New Guinea.



## Nature has an intrinsic value

Vestre uses environmentally-certified wood from what is probably the world's most sustainable forestry sector. For every tree that is felled, at least one new tree is planted. We never offer rainforest timber, as loss of rainforest is a global problem. In 2017, we launched the world's first Nordic Swan Eco-labelled bench. Today, we have over 300 environmentally certified products and we have no intention of stopping there. We have a brand-new product series called Vestre Habitats, the goal of which is to increase knowledge and awareness of loss of biodiversity through functional and thoughtfully designed furniture that encourages natural processes. We also work with Farm for the Future on developing more sustainable farming in Tanzania.

Vestre's vision is to not make a single product that cannot last forever. Hvilan benches have stood in Vækerø in Oslo for over 30 years for the benefit of people of all ages.



# Product overview

## Benches

New!



Briskeby → p. 214

New!

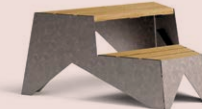

Stoop → p. 259

New!



Urban → p. 268



Air → p. 180



April → p. 184



April → p. 187



April Go → p. 193



Atlas → p. 197



Bloc → p. 201

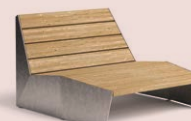

Bloc → p. 206



Code → p. 221

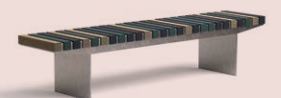

Coast → p. 221



Corner → p. 222



Dialog → p. 223



Edo → p. 225



Parc → p. 243



Plinth → p. 248



Pop → p. 250



Folk → p. 225



Forum → p. 228



Forum → p. 227



Porto → p. 252



Stones → p. 258

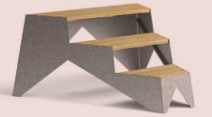

Stoop → p. 259



Hvilan → p. 234



Kong → p. 238



Kyoto → p. 239



Stripes → p. 260



Stripes → p. 262



Urban → p. 264



Move → p. 240

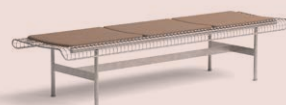

Munch → p. 241



Munch → p. 241



Via → p. 275



Vroom → p. 278



Vroom → p. 281

# Tables



Air → p.180



April → p.189



April → p.188



Hvilan → p.235



Kong → p.238



Kyoto → p.240



April Go → p.194



April Go → p.195



Berlin → p.200



Munch → p.242



Parc → p.243



Plinth → p.249



Bloc → p.206



Bloc → p.206



Pop → p.251



Urban → p.267



Vroom → p.283



Folk → p.226



Forum → p.229



Forum → p.229



Vroom → p.283



# Chairs

New!



April Go → p. 193

New!



Kinn → p. 236



April bar chair → p. 183



April Go → p. 192



April → p. 182



Berlin → p. 199



Bloc → p. 200



Kong → p. 239



Parc → p. 243



Munch → p. 242



Munch → p. 241



Munch → p. 241



# Multi-purpose furniture

New!



Urban → p. 268

New!



Kong → p. 239



April → p. 187



Atlas → p. 196

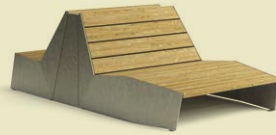

Bloc → p. 206



Code → p. 221



Forum → p. 228



Stones → p. 258



Stoop → p. 259



Stripes → p. 261



Via → p. 275



Vroom → p. 281

# Picnic tables

New!



April → p. 185

New!



Stoop → p. 259



Berg → p. 198



Buzz → p. 214



Hvilan → p. 235



## Litter bins



Acceptor → p. 178



Acceptor → p. 178



April → p. 191



Bloc → p. 210



City → p. 217



City → p. 215



Dialog → p. 224



Dialog → p. 224



Folk → p. 226



Forum → p. 230



Urban → p. 269



Vroom → p. 286



# Planters



April Go → p. 195



April Go → p. 195



Bloc → p. 211



Boboli → p. 212



Code → p. 221



Code → p. 221



Parklets 2.0 → p. 244



Pop → p. 252



Reale → p. 255



Stripes → p. 262



Stones → p. 258

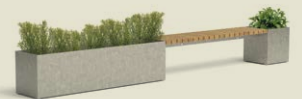

Vroom → p. 286



## Bicycle racks



Berg → p. 199



Bøy → p. 215



City → p. 220



Cycle → p. 223



Folk → p. 227

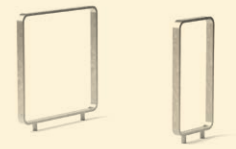

Forum → p. 230



Plinth → p. 249



Sinus → p. 257



Tour → p. 263



Urban → p. 273



Vega → p. 274



Vroom → p. 287



## Parklets 2.0



Café → p. 244



Cosy → p. 245



Forest → p. 245



Cycling → p. 245



Portal → p. 244



Urban flooring → p. 244

# Vestre Habitats

New!



Decay Edge → p. 231

New!

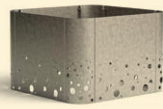

Decay Edge → p. 231

New!



Leaf → p. 232

New!

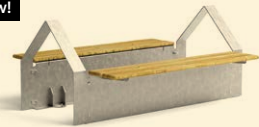

Log → p. 233

New!

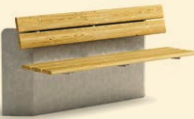

Pile → p. 233

New!

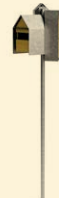

Wings → p. 233

# Bollards, guards, walls and shelters



Hvilan → p. 235



Hvilan → p. 236



Cover → p. 222



Pop → p. 251



Urban → p. 271



Urban → p. 272



# News

Ten years ago, we opened our our Snøhetta designed steel factory in Torsby, Sweden. Award-winning photographer Einar Aslaksen stood ready to photograph the new products. Now he's back to do the same again. This time at The Plus, our new furniture factory in Magnor, designed by BIG Bjarke Ingels Group. We are now presenting our new products for 2022 at the world's most environmentally friendly furniture factory. The beautiful production facility, surrounded by a mighty Norwegian pine forest, contains furniture from Scandinavia's leading designers.





Name: Kinn lounge chair  
Designed by: Anderssen & Voll  
RAL: 1024, linseed oil-treated pine

The Kinn lounge chair is made of Hydro CIRCAL which consists of at least 75% recycled aluminium. This is the highest content of recycled material on the market, which means drastically reduced energy consumption, while the product is also of high quality and durable. Kinn is comfortable, stackable, and easy to move around as needed. It is part of a larger furniture family that will be launched in 2022.



At three metres, the Briskeby bench is the longest single bench in our collection. It works brilliantly as a generous and social meeting place with room for many. The bench has a timeless Scandinavian aesthetic with expansive steel and wooden surfaces and is elegant and comfortable. It comes in linseed oil-treated Nordic pine as standard. It also comes in painted Accoya.

Name: Briskeby bench  
Designed by:  
Andreas Engesvik  
RAL: 6011,  
painted Accoya



Name: Briskeby bench  
Designed by: Andreas Engesvik  
Hot dip galvanised steel, linseed oil-treated pine

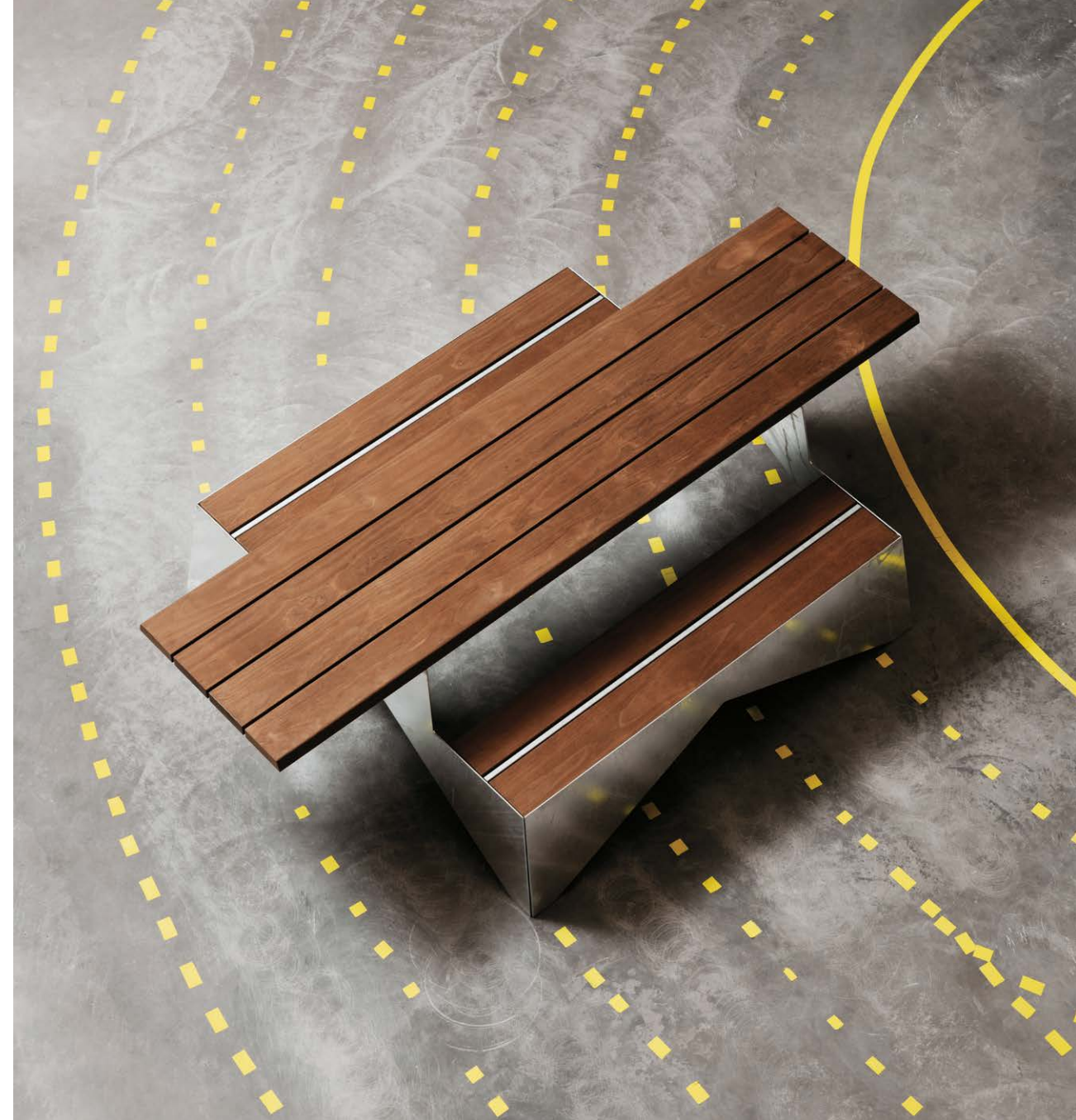

Name: Stoop picnic bench  
Designed by: Julien De Smedt  
Hot dip galvanised steel, Kebony

The Stoop picnic bench is an expansion of the Stoop family and builds further on the idea of using steps as seating in public places. The Stoop picnic bench works as a social and informal meeting place for people of all ages.



Name: Urban sun bench  
Designed by: Arthur Wozniak  
& Hallvard Jacobsen  
Hot dip galvanised steel,  
linseed oil-treated pine

The Urban sun bench is perfect for longer meetings with its high comfort level, ergonomics and generous seating surface. The sun bench is an expansion of the popular and versatile Urban series.



Name: Stoop Mini bench  
Designed by:  
Julien De Smedt  
RAL: 1005, oiled oak

The Stoop Mini bench is a smaller version of the popular Stoop bench. It works as a social and playful meeting place and is based on the universal idea of using steps as seating. Its shape enables several benches to form an urban auditorium where each bench has space for up to five people.

# Vestre Habitats

Urban parks and green spaces represent important natural ecosystems, and Vestre is investigating how we can achieve greater biodiversity in urban areas through smart furniture design and vegetation. That's why we've created Vestre Habitats. A million species of animals, plants and fungi are now threatened with extinction. Biodiversity is important for all life on earth because it contributes to stable ecosystems. Natural diversity can be preserved through more knowledge and protection. We want to work to increase knowledge and awareness as well as reverse this negative trend with our contribution: functional and thoughtfully designed furniture which protects natural processes such as decomposition. An apparently lifeless log can hide a teeming universe of microscopic species and habitats.



Name: Wings bird house  
Designed by: Arde  
RAL: 6002

The Wings bird house is part of the Vestre Habitats series, where the products are designed to protect and increase biodiversity in cities. The lack of safe nesting spaces means that new flocks of birds are often unable to establish themselves. This problem could be overcome by putting up more nest boxes. The Wings bird house is one such solution and comes in several variations.

Name: Log bench  
Designed by: Arde  
RAL: 1012

The Log bench makes it possible to frame and arrange logs and branches in an organised stack so that you can sit on the bench and watch the slow decomposition process. Fallen trees are vital for conserving biodiversity, as they are home to many rare species of insects, fungi, lichen, mosses and plants. Many birds and bats need hollow trees to nest and reproduce in, and birds also need resting places.



Name: Decay Edge  
planter, Leaf insect hotel,  
Wings bird house  
Designed by: Arde &  
Rethink Studio  
RAL: 1005

Decay Edge is a combination of a compost bin and a planter. It makes it possible to create living microhabitats by combining elements such as stone, wood, organic materials, soil, plants and water. This is how you create an environment where small creatures can live, hide and find food. The modular system is available in a number of different sizes and shapes so that it's easy to adapt to various surroundings.

Leaf is an insect hotel that gives insects a home in urban neighbourhoods. The shape of the product is based on a stylised leaf. The design is minimalistic and also has a sculpture-like character which can easily be placed either alone or in groups. Leaf can be placed in planters, flower beds, on roof terraces or in parks—you can let your imagination run wild. The most important thing to remember is to ensure that biological, species-typical parameters are considered in order to enrich the opportunities for insects to survive in urban environments.

Name: House bench  
Designed by: Arde  
RAL: 5013

The House bench makes it possible to frame and arrange logs and branches in an organised stack so that you can sit on the bench and watch the slow decomposition process. Old trees are vital for conserving biodiversity, as they are home to many rare species of insects, fungi, lichen, mosses and plants. Many birds and bats need hollow trees to nest and reproduce in, and birds also need resting places.



Name: Pile bench  
Designed by: Arde  
RAL: 4007

With the Pile bench, excess materials such as large stones and gravel can easily be arranged into small piles. These piles create variations in light, temperature and humidity. They also store heat from the sun, which is handy for heat-loving insects and reptiles.



# re- connect

**Norway** > Oslo + Stavanger +  
Asker + Bærum + Spikkestad  
+ Tjøme + Strynefjellet | **Italy**  
> Milan | **USA** > Albertville + Atlanta  
+ Austin + Brooklyn + Dallas +  
Los Angeles + New York + Oakland  
+ Seattle + Washington, D.C. |  
**Germany** > Bremen + Dorsten +  
Schwarzenbeck + Staufenberg |  
**Sweden** > Stockholm + Uppsala  
| **UK** > Brighton +  
London | **Ireland** > Dublin





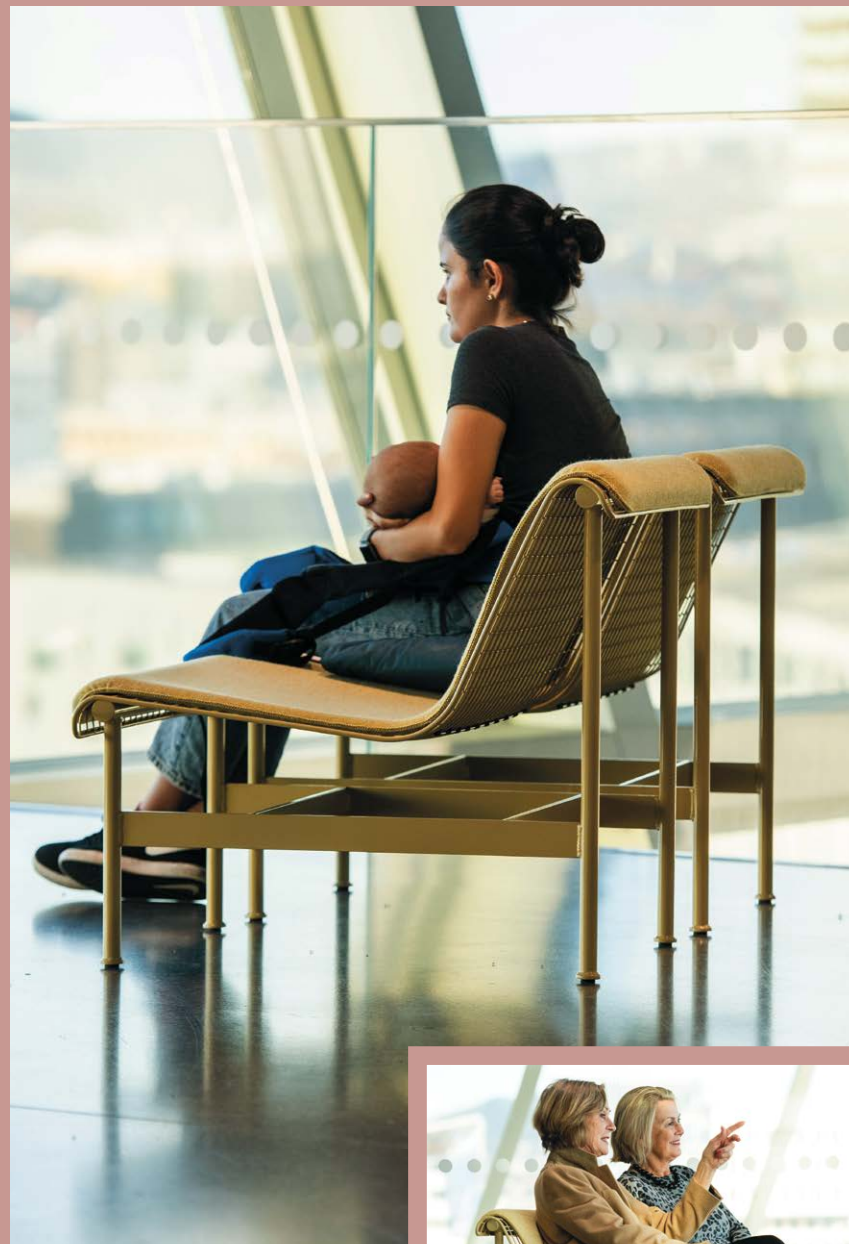

Product: Munch  
RAL: 1001, 6013 G12





Product: Munch  
RAL: 3012 G12, 6021 G12, 6034 G12



Norway → Oslo ↓ Operastranda →

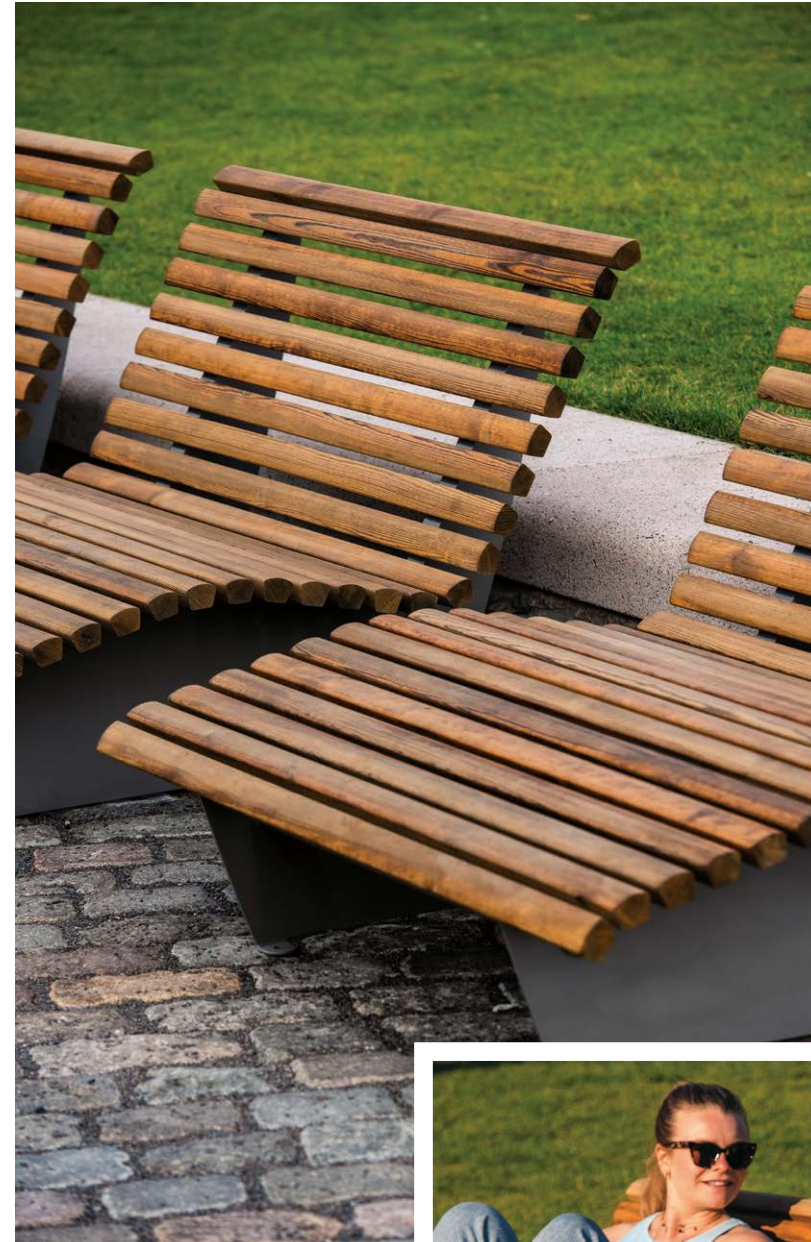

Product: Urban  
RAL: 9007





Product: Stripes  
RAL: 1036, 9004 G12

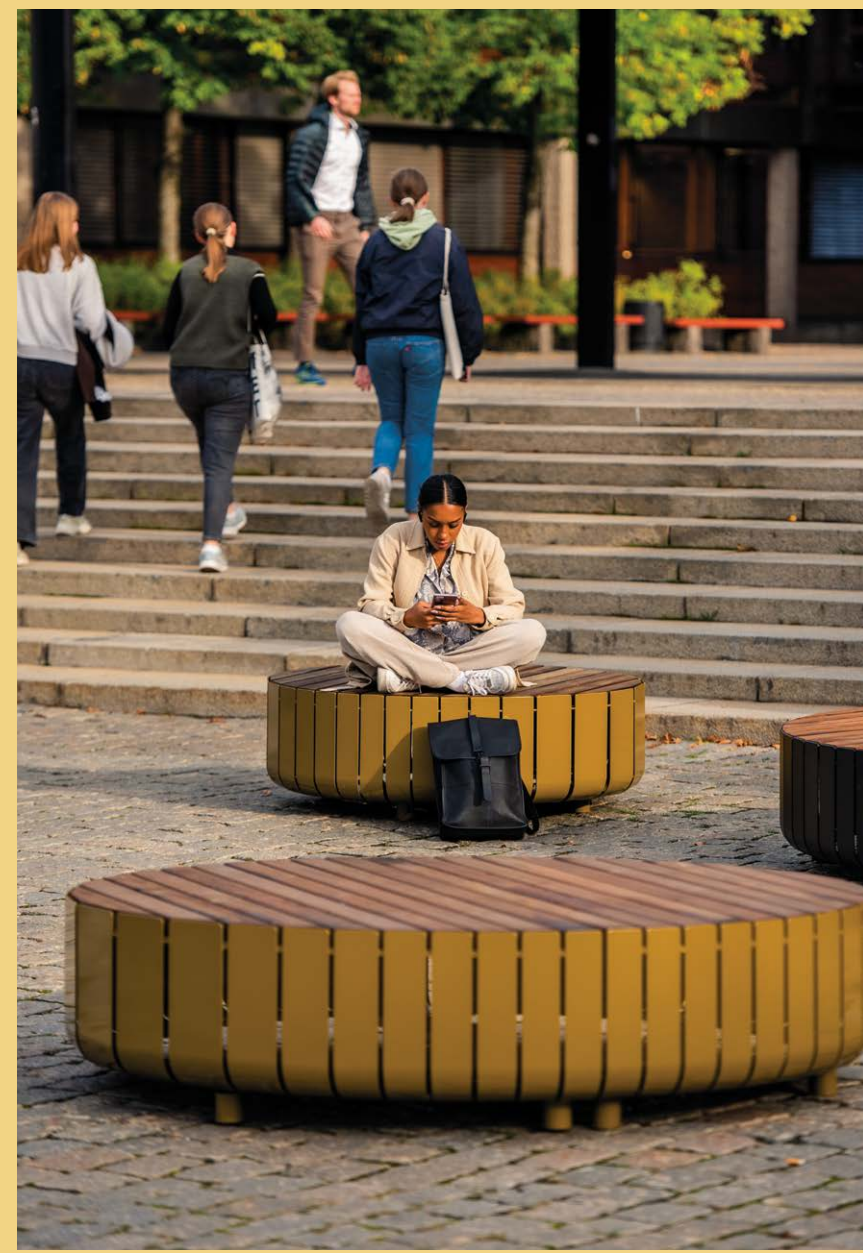

Product:  
Vroom, Stripes  
RAL: 1036, 9004 G12

Norway → Bærum ↓ The dementia village



Product: Parc  
RAL: 6024

Norway → Oslo ↓ Voldsløkka

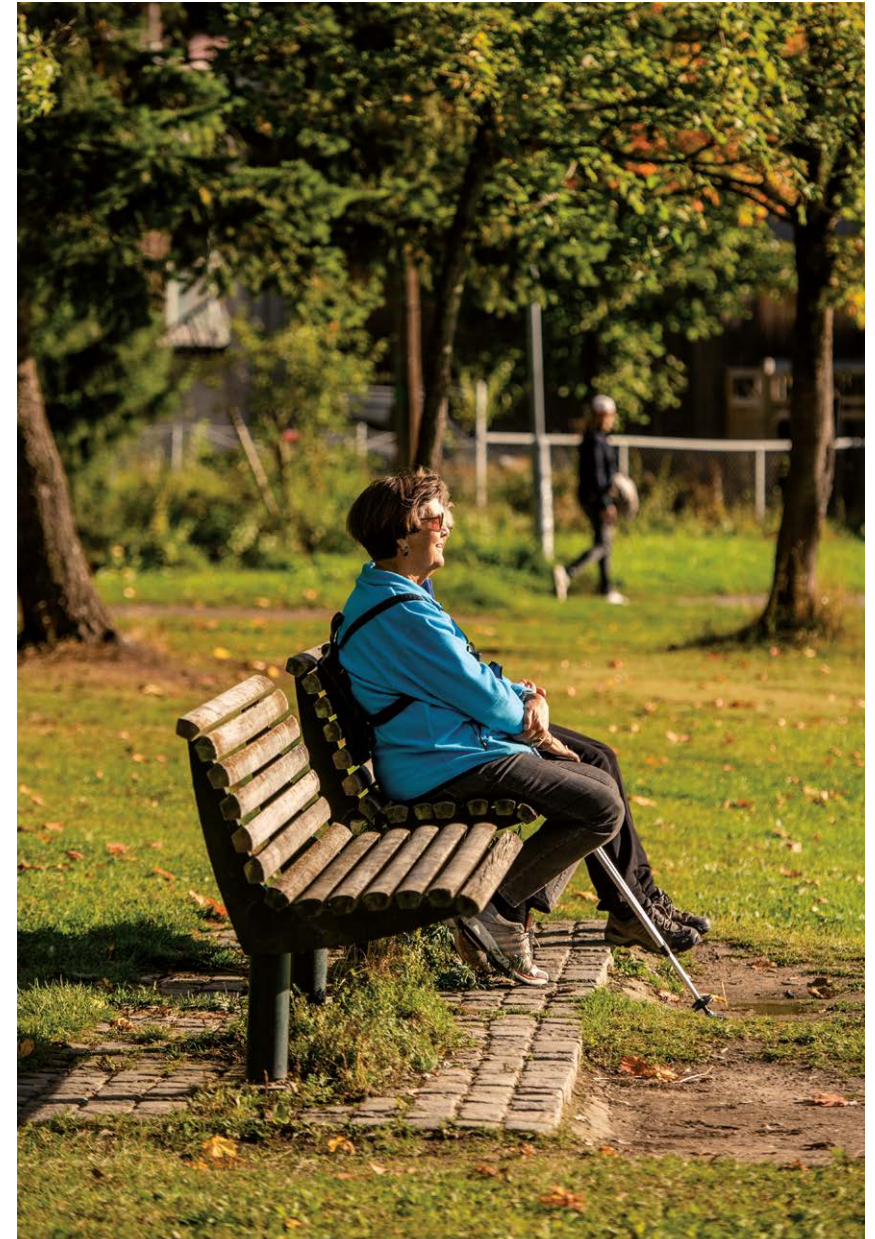

Product: Urban  
RAL: 6012



Product: Porto, Stoop  
RAL: 5018, 6027



Norway → Oslo ↓ Vestli School →



Product: Move, Bloc, Stones  
RAL: 2000, 2001, 2004, 5011



AWARD FOR DESIGN EXCELLENCE  
NORWEGIAN DESIGN COUNCIL



Norway → Oslo ↓ Villa Grande



Product: Porto  
RAL: 9006

  
AWARD FOR DESIGN EXCELLENCE  
NORWEGIAN DESIGN COUNCIL

Product: Pop  
RAL: 3016



Product: Folk  
RAL: 5017

Norway → Asker ↓ Heggedal torg →



Product: Atlas, Forum  
RAL: 8012

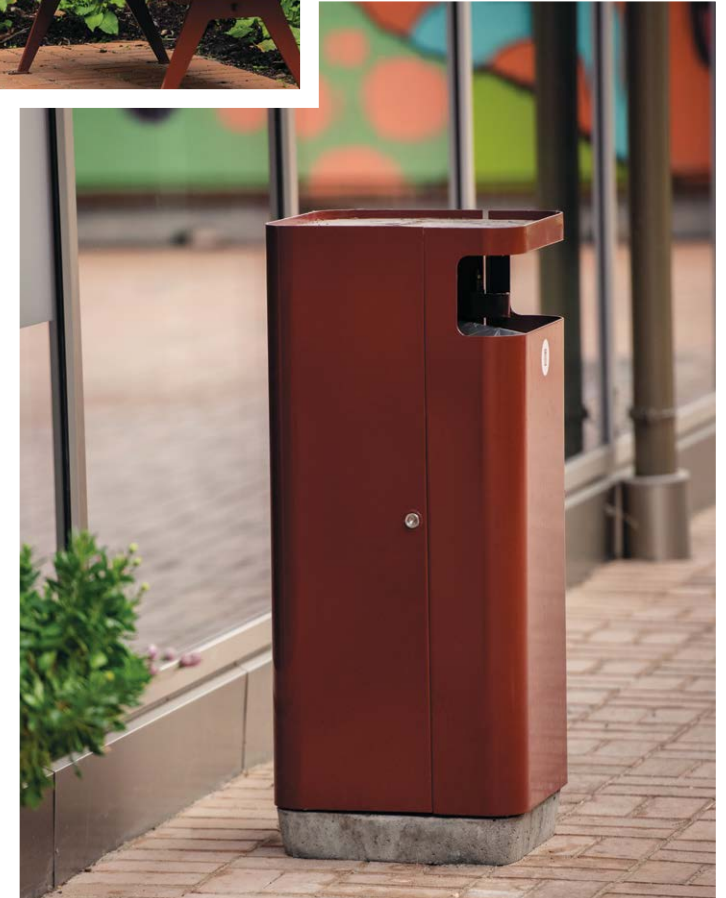



Product: Code, Bloc  
RAL: 6011, 6021



Product: Vroom  
RAL: 2009,



Product: Stoop  
RAL: 5005

Norway → Tjøme ↓ Verdens ende



Product: Coast  
RAL: 1013, recycled  
ownerless marine plastic

Norway → Strynefjellet ↓ Resting place



Product: Kyoto  
Low-carbon concrete









Product: Bloc  
RAL: 7047

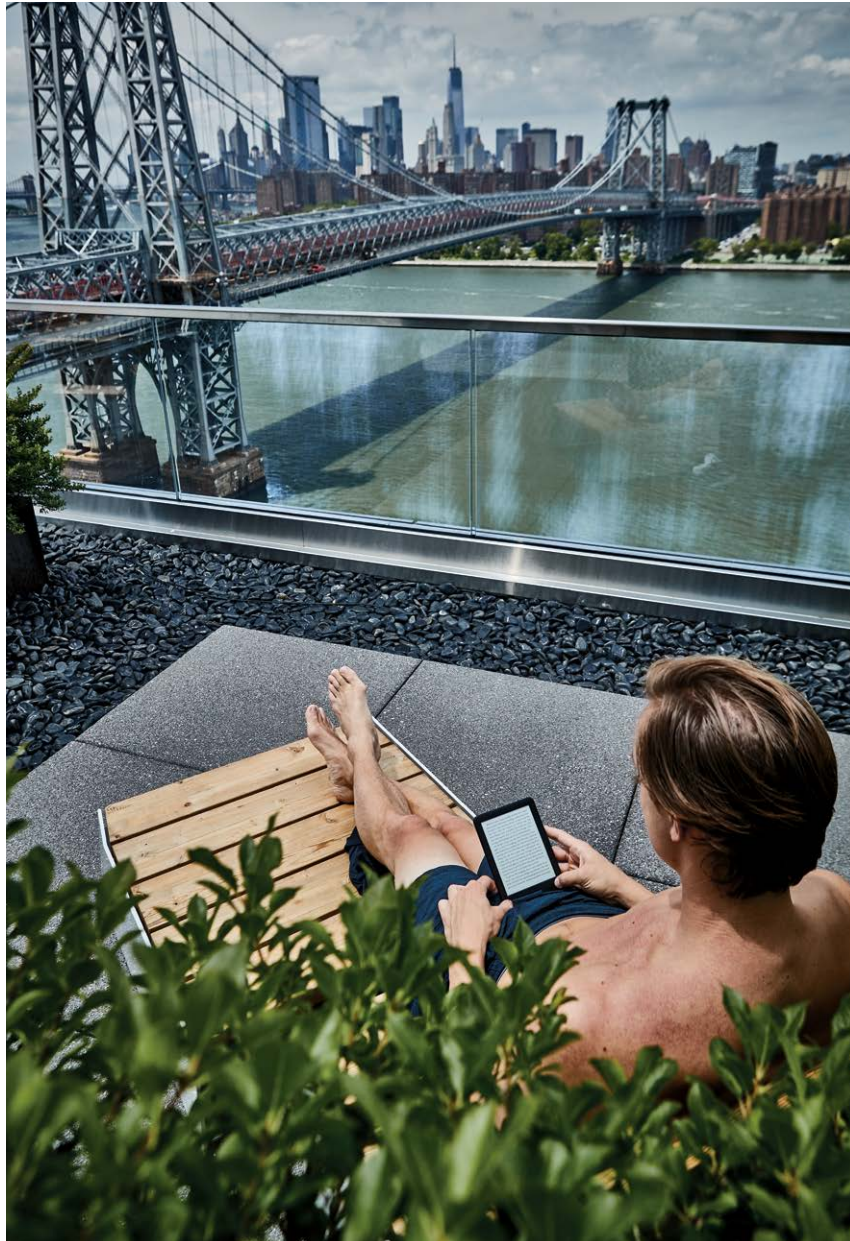

USA → Brooklyn ↓ One South First →



Product: Via, Stripes  
RAL: 7036



Product: Bloc,  
Kong, Stripes, Via  
RAL: 7036



Product: April perforated  
RAL: Bespoke



Product: April Go  
RAL: 2009



Product: Bloc  
RAL: 1021, 3020, 5017



USA → New York ↓ Hudson Yards



Product: Bloc  
RAL: 6021



Product: April GO, Stoop, Stripes,  
RAL: 7012, hot dip galvanised steel

USA → Los Angeles ↓ 800 North Brand



Product: Air  
RAL: 5012

USA → Dallas ↓ The Plaza at Solana



Product: Bloc, Vroom bespoke  
RAL: 9003

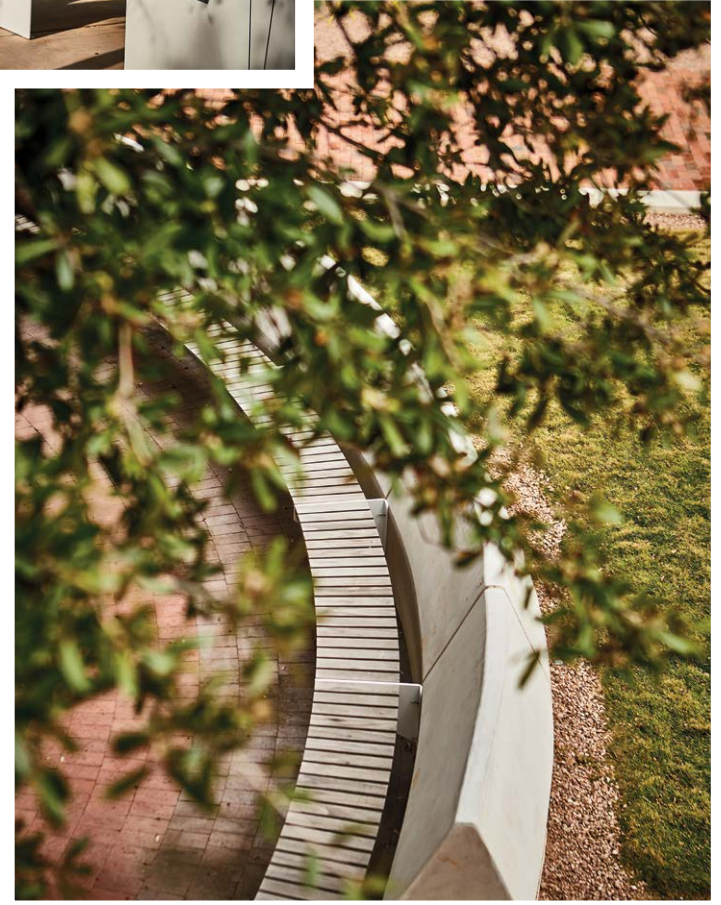

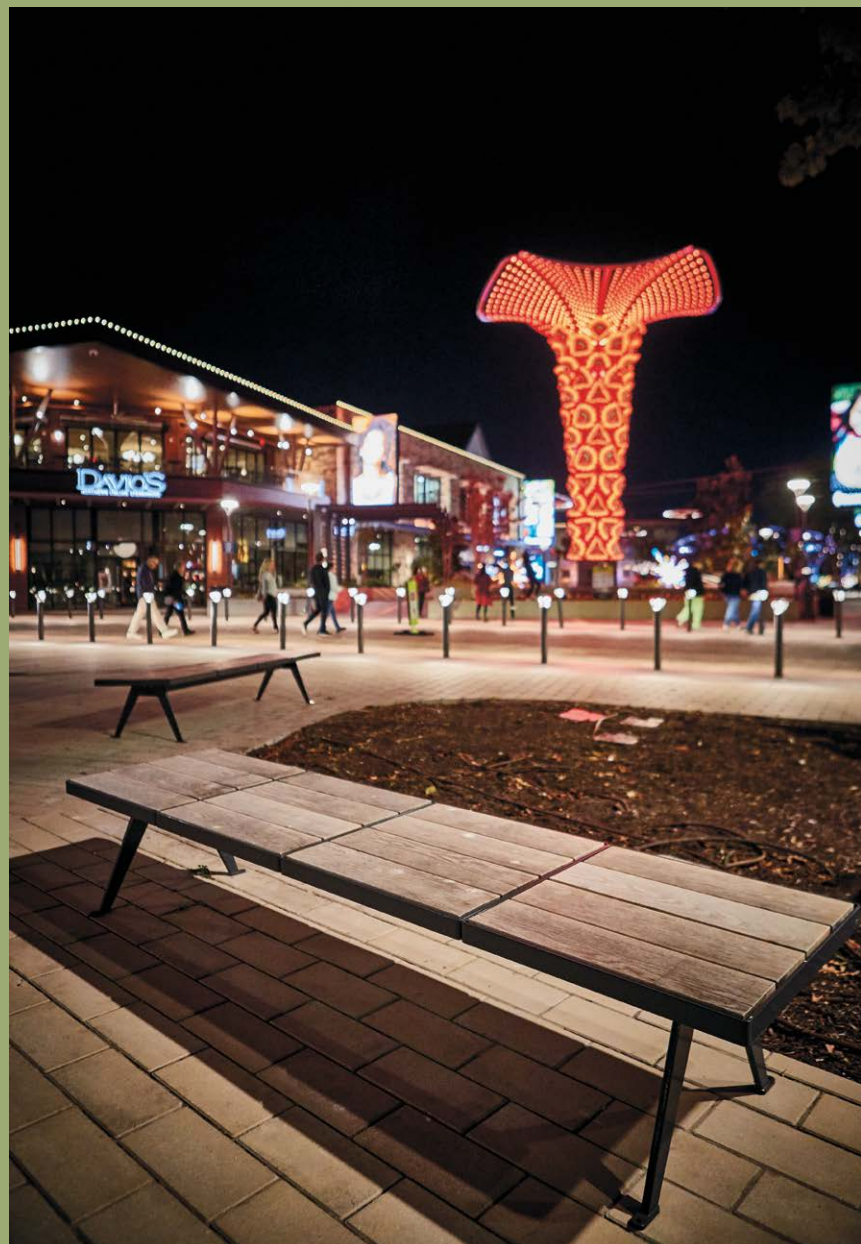





Product: Bloc  
RAL: 1028

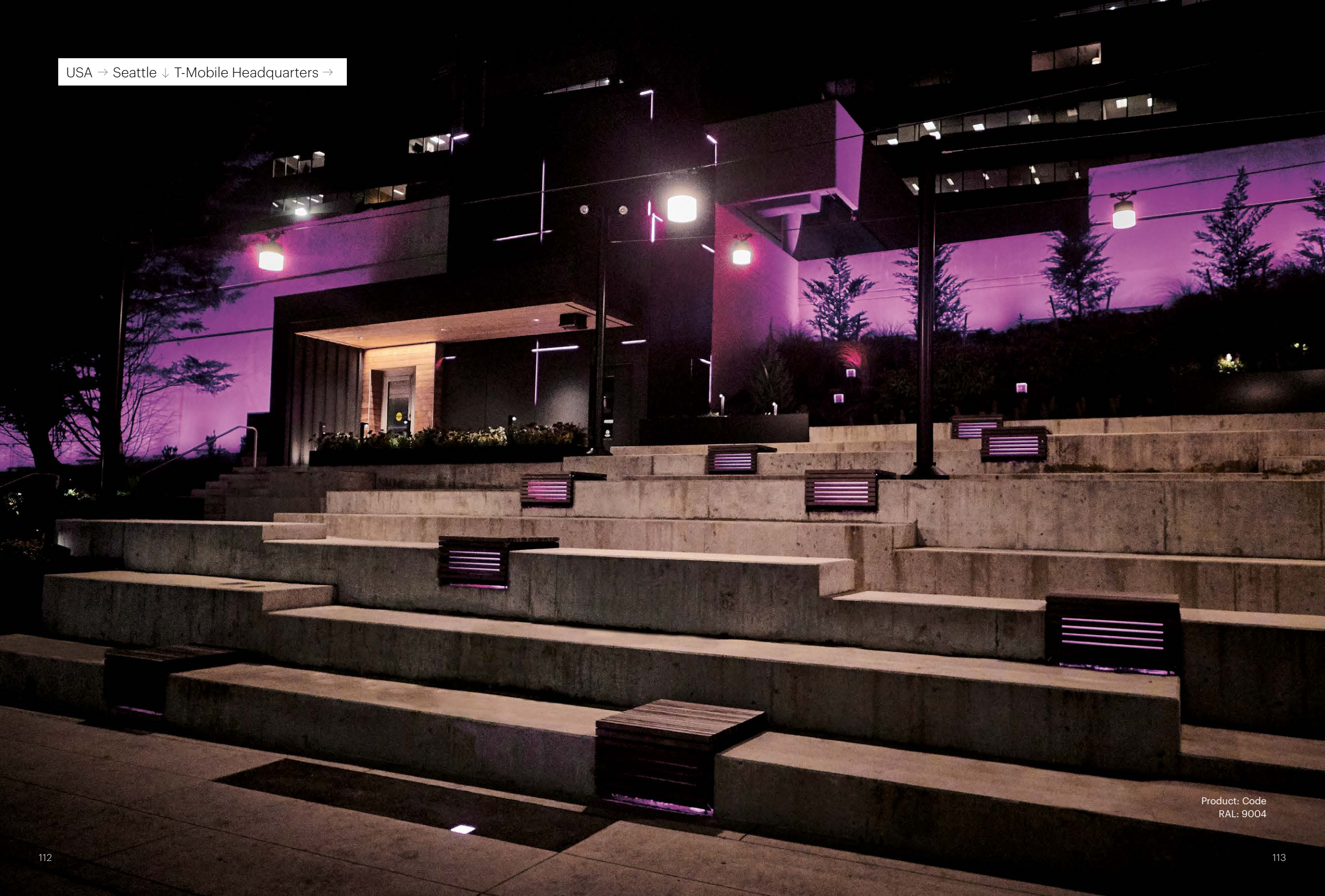



Product: Code  
RAL: 9004



USA → Atlanta ↓ Ponce New City



Product: Vroom  
RAL: 7005



Product: Via bespoke  
Stainless steel



Product: Buzz, Vroom  
RAL: 6027, 7022,  
hot dip galvanised steel



Product:  
Vroom, April Go  
RAL: 6027, 7022,  
hot dip galvanised  
steel



Product: Vroom, Berg  
RAL: 7022, hot dip galvanized steel



Product: Corner, Vroom  
Hot dip galvanized steel





Product: Bloc, Forum  
RAL: 5009, 5024



Germany → Durbach ↓ Schloss Staufenberg →



Product: Plinth, Bloc  
RAL: 6032



AWARD FOR DESIGN EXCELLENCE  
NORWEGIAN DESIGN COUNCIL



Product: Via  
RAL: 2011

Product: Stones  
RAL: 1021, 3020



Product: Parklets 2.0  
RAL: 5014

Germany → Dorsten Freizeitpark ↓ Maria Lindenhof Park →



Product: Bloc  
RAL: 1016

Product: Acceptor  
RAL: 2004





Product: April  
Hot dip galvanised steel



Sweden → Stockholm ↓ Raoul Wallenbergs torg →



Product: City  
RAL: 9005



Product: City  
RAL: 9005

Sweden → Stockholm ↓ Vasaparken



Product: April  
RAL: 7012

Sweden → Stockholm ↓ Sjöviksskolan

AWARD FOR DESIGN EXCELLENCE  
NORWEGIAN DESIGN COUNCIL



Product: April  
RAL: 5014





Sweden → Stockholm ↓ Skrapan

Product: Stripes,  
Bloc perforated  
RAL: 3012, 5017



Sweden → Stockholm ↓ Malmkillnadsgatan



Product: Parklets 2.0, Pop  
RAL: 1016, 6028



Product: Stripes, April  
RAL: 7024



Sweden → Uppsala ↓ Rosendal →



Product: Kong, Berlin  
RAL: 7016





Product: Berg,  
Buzz, April Go  
RAL: 1004, 1012

UK → London ↓ Finsbury Park



Product: Bloc, Forum  
RAL: 1023, 7015, stainless steel

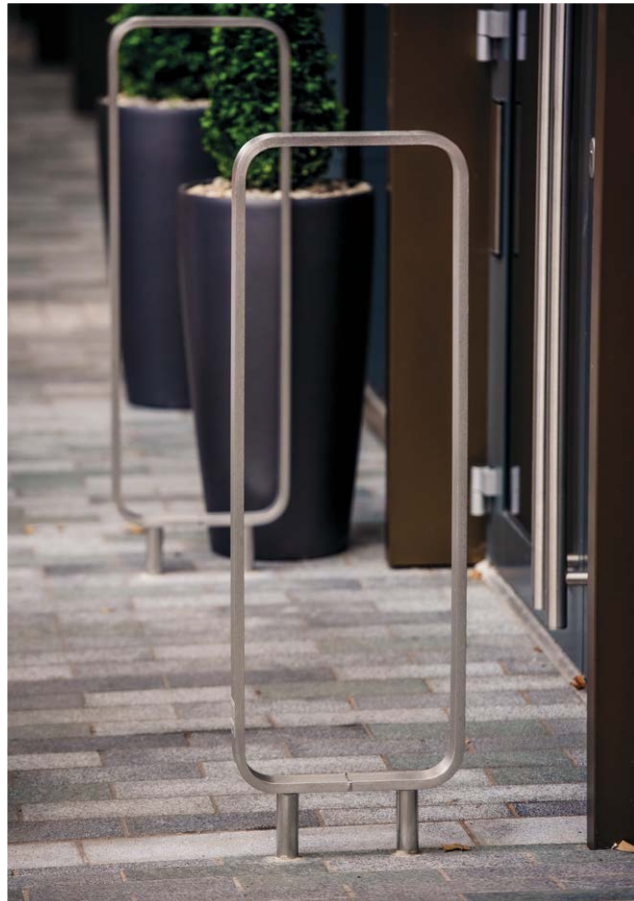

UK → London ↓ Fitzroy & Warren Street



Product: Code, Bloc  
RAL: 5013, 6034

UK → London ↓ Creechurch Lane



Product: Parklets 2.0  
RAL: 6018, 6027

UK → London ↓ King's Cross



Product: Via  
Hot dip galvanised  
steel

UK → London ↓ Elephant Park →



Product: Vroom, Forum  
RAL: 7016 G30



UK → London ↓ Old Street



Product: Porto  
RAL: 9022

UK → London ↓ UCA Farnham

AWARD FOR DESIGN EXCELLENCE  
NORWEGIAN DESIGN COUNCIL



Product: Vroom  
RAL: 7016





Product: Bloc  
RAL: 9007

# About Vestre













## We manufacture in Scandinavia

All our products are designed and manufactured in Scandinavia using renewable energy, local materials and environmentally friendly production technology. Norway, Sweden and Denmark have a combined population of 21 million. We can't all be the best at everything. That's why we collaborate with the best people in each individual production area. And that's why our products have a little piece of Scandinavia within them. Vestre has two factories, one in Sweden and one in Norway. Our steel factory in Torsby, Sweden opened in 2013 and was designed by the Norwegian architecture firm Snøhetta. The second, the world's most environmentally friendly furniture factory, is in Magnor in Norway and was designed by the Danish architecture firm BIG Bjarke Ingels Group. All the products that are produced here are quality and environmentally certified in accordance with ISO 9001 and ISO 14001, and we continuously work on innovation and improvements driven by our employees.













































# Designers

	<b>Allan Hagerup</b> → Coast, Kong, Move, Parc
	<b>Allan Hagerup &amp; Einar Smette-Blålid</b> → Dialog
	<b>Anderssen &amp; Voll</b> → Edo, Kinn
	<b>Andreas Engesvik</b> → Briskeby
	<b>Andreas Engesvik &amp; Jonas Ravlo Stokke</b> → Munch
	<b>René Hougaard, Arde</b> → Decay Edge, House, Log, Pile, Wings
	<b>Artur Wozniak</b> → Acceptor
	<b>Artur Wozniak &amp; Hallvard Jakobsen</b> → Cover, Urban, Via
	<b>Ashley Conn &amp; Ole Rydningen, Sola</b> → Parklets 2.0
	<b>Atle Tveit</b> → Air
	<b>Atle Tveit &amp; Lars Tornøe</b> → Bloc
	<b>Espen Voll, Michael Olofsson &amp; Tore Borgersen</b> → April, April Go, Atlas, Berg, Berlin, Buzz, Forum, Porto, Stones, Vroom
	<b>Geir Øxseth, Jahn Aamodt, Svein Knutsen, Kai Wood &amp; Bjarne Aasen</b> → Hvilan

	<b>Hallvard Jakobsen</b> → Tour
	<b>Front</b> → Folk
	<b>Hong Ngo-Aandal &amp; Johan Verde</b> → Code Square, Parklets 2.0
	<b>Jarle Slyngstad &amp; Roy Fiddaman</b> → City, Hvilan
	<b>Julien De Smedt</b> → Stoop
	<b>Kristin Schanche, Hareide Design</b> → Kyoto
	<b>Kristine Five Melvær</b> → Pop
	<b>Lars Jørstad Nordbye, Snøhetta</b> → Bøy
	<b>Lars Tornøe</b> → Corner, Stripes
	<b>Note Design Studio</b> → Plinth
	<b>Ola Bettum</b> → City, Sinus
	<b>Alexander Qual, Rethink Studio</b> → Leaf
	<b>Sanna Lindström</b> → Cycle

# Design awards and the Nordic Swan Ecolabel

	→ April	 AWARD FOR DESIGN EXCELLENCE NORWEGIAN DESIGN COUNCIL	
	→ April Go	DOGA AWARD Design and Architecture	
	→ Berg		
	→ Bloc	 AWARD FOR DESIGN EXCELLENCE NORWEGIAN DESIGN COUNCIL	
	→ Buzz		
	→ City		
	→ Code		
	→ Dialog	 AWARD FOR DESIGN EXCELLENCE NORWEGIAN DESIGN COUNCIL	
	→ Folk	DOGA AWARD Design and Architecture	
	→ Forum		
	→ Hvilan	 AWARD FOR DESIGN EXCELLENCE NORWEGIAN DESIGN COUNCIL	
	→ Kyoto	 AWARD FOR DESIGN EXCELLENCE NORWEGIAN DESIGN COUNCIL	
	→ Munch	DOGA AWARD Design and Architecture	

	→ Plinth		
	→ Porto	 AWARD FOR DESIGN EXCELLENCE NORWEGIAN DESIGN COUNCIL	
	→ Stoop	 AWARD FOR DESIGN EXCELLENCE NORWEGIAN DESIGN COUNCIL	
	→ Stripes	 AWARD FOR DESIGN EXCELLENCE NORWEGIAN DESIGN COUNCIL	
	→ Urban	 AWARD FOR DESIGN EXCELLENCE NORWEGIAN DESIGN COUNCIL	
	→ Vroom	 AWARD FOR DESIGN EXCELLENCE NORWEGIAN DESIGN COUNCIL	



The DOGA Award for Design and Architecture is Norway's most important recognition of companies and practitioners who excel through outstanding use of design and/or architecture.



The German Design Awards are the international awards from the German Design Council and are among the most well-known design awards worldwide.



The Nordic Swan Ecolabel is the official environmental label for Nordic countries working to reduce the environmental impact of the production and consumption of goods—and to make it easier for consumers and professional buyers to choose the most environmentally friendly goods and services.

## VestreQualityProgramme™

### **We offer a lifetime guarantee against rust**

At Vestre, we use hot dip galvanised steel and aluminium that doesn't rust. All our products therefore come with a lifetime guarantee against harmful rust. The guarantee covers normal use. Please be aware that some discolouration may occur after many years of use in exposed environments.

### **We offer a 15-year guarantee on powder coating and wood**

Vestre offers a 15-year adhesion guarantee on powder-coated surfaces as long as they are not exposed to mechanical damage, impact, corrosive chemicals or similar. We also offer a 15-year guarantee against rot damage on standard linseed oil-impregnated pine and a 30-year guarantee on Kebony. The guarantee requires the wood to have been kept clear of dirt and vegetation, and for high-pressure washing or chemicals that can damage the surfaces and wash away the protective oil not to have been used. Wood is a living material, and it is natural for small cracks to appear over time.

### **The parts never go out of date**

What if misfortune strikes? If the product is exposed to vandalism or there is a need for extended maintenance, we can help. Vestre supplies all spare parts throughout the product's lifetime. And if we don't have the parts in stock, we'll make them for you.

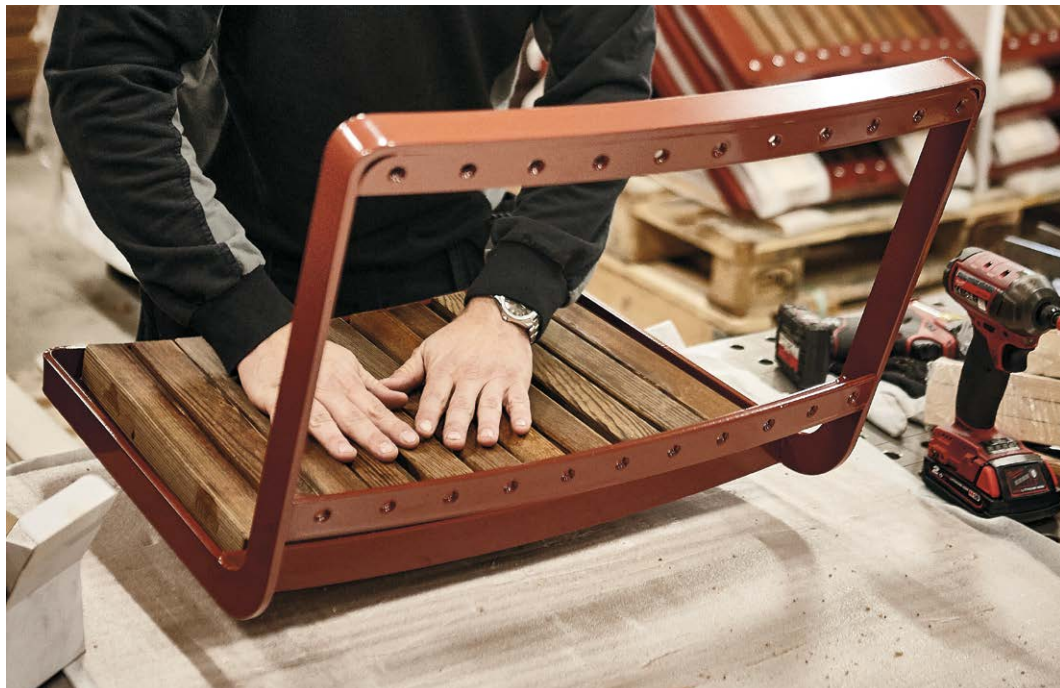

## Everything lives longer with a bit of love

Furniture from Vestre requires minimal maintenance, but we recommend that you inspect it every once in a while, so that any damage can be fixed. After all, everything lasts longer with a little TLC. Screws and bolts should be checked and retightened after a few weeks. Steel parts should be cleaned regularly and as needed, but please be aware that strong chemicals can affect the surface. Standard linseed oil-impregnated pine has a natural colour which will turn grey over time. The wood will have a longer lifespan if the wooden details are oiled every three to five years. How often depends on wear and tear and climate.

## Nordic steel and aluminium have lower emissions

Vestre uses high-quality Nordic steel and aluminium with the lowest possible carbon footprint. The worldwide steel industry accounts for approximately 7% of global greenhouse gas emissions. In Scandinavia, we produce steel with up to 30% lower than average emissions. The same applies to aluminium—energy consumption here is significantly lower and greenhouse gas emissions are up to 8 times lower than the average. Most of the aluminium we use has a recycled content of 75%. This is possible thanks to new technology and the large share of renewable energy. Our products are sturdily dimensioned to withstand harsh use. We cut the metal with high-tech laser machines, which ensures high precision and minimal waste of resources. We also weld both manually and with welding robots. Finally, the remaining metal is sent back to the plant and recycled.

## Lifetime guarantee against rust

All steel components from Vestre are hot-dip galvanised in a zinc bath at a temperature of around 450°C. The bath is heated using 100% renewable energy. The process forms a corrosion-protective alloy (80–120 µ) which means the product can remain outdoors for several decades. Approximately 2–4 µ of the alloy disappears in the first year, and after that 1–2 µ per year as a result of weather and wind. Hot dip galvanisation was patented by French engineer Sorel in 1837. The process takes place in accordance with ISO 1461 and strict environmental regulations. Zinc (Zn) is an important building block which occurs naturally in stone, water and humans. At Vestre, we use zinc produced in Odda in Norway. Hot-dip galvanised steel will 'heal' itself if the surface is damaged - the zinc contracts and forms a new alloy over the damaged area. This is called cathodic protection. If the steel is powder-coated after hot-dipping (Duplex system), it will have an even longer lifetime since the powder coat protects the zinc alloy.

## Powder coating developed for the North Sea

Before powder coating, we thoroughly treat the metal in a multi-step process. This is done through pre-treatment with sprays which consist of degreasing, pickling, purified water and activators. The powder itself is completely free of solvents. We apply the electrostatically charged powder coating using sophisticated robots. Finally, the powder is melted in a curing oven that gives the product its final appearance. This process was developed in Norway to provide a high-quality finish to comply with the strict standards in corrosion class C5-M (ISO 12944). Vestre offers around 200 RAL Classic colours at no additional cost.

Corrosion Class (EN ISO 12944)	Examples
C1	Heated buildings
C2	Outdoors in inland areas or in warehouses where condensation may occur
C3	Outdoors in coastal climates with little salt content or indoors in production facilities with high humidity levels
C4	Outdoors in coastal climates with moderate salt content or in indoor swimming pools
C5-I	Outdoors in coastal climates with high salt content
<b>C5-M/CX</b>	<b>Outdoors in coastal climates with high salt content, high humidity levels, and aggressive atmospheric corrosion</b>

## We use only sustainable wood

For our furniture, we use high-quality FSC® certified pine from Norway and Sweden as standard (*Pinus sylvestris*). Scandinavia has one of the world's most sustainable forestry sectors. The cold Nordic climate makes the trees grow slowly and they are not felled until they are 80–120 years old. This means that Scandinavian pine is harder and better suited for use in outdoor furniture than pine from warmer regions, which normally grow 3–5 times faster. The wood we use is impregnated with linseed oil which protects against rot. After some time outdoors, the surface develops a natural grey patina. At Vestre, we don't offer wood from rainforests. We use the more environmentally friendly option of Kebony. The technology behind Kebony® is an environmentally friendly and patented wood treatment process, developed in Norway. This process improves the wood's properties using biobased liquid. The wood's cellular structure is permanently altered and acquires a very special quality – as well as a deep brown colour that we also find in tropical tree species. When the furniture has been outside for a period of time, the surface acquires a natural silver-grey patina. We use FSC® certified pine (*Pinus radiata*) from New Zealand for Kebony treatment. After this treatment, Kebony is even harder and more durable than teak and mahogany. For indoor use, we always recommend oak or ash, which we also offer. In addition, we supply offer products containing fire-retardant wood where required.

Colour	Type of wood	Durability EN 350 (1 = very durable, 5 = not durable)	Hardness EN 1534 (Brinell N/mm <sup>2</sup> )
<b>A</b>	Kebony ( <i>Pinus radiata</i> )	1	41
<b>B</b>	Oiled oak ( <i>Quercus</i> )	2	33
<b>C</b>	Oiled ash ( <i>Fraxinus</i> )	2	30
<b>D</b>	Linseed oil proofed Nordic pine ( <i>Pinus sylvestris</i> )	1	19

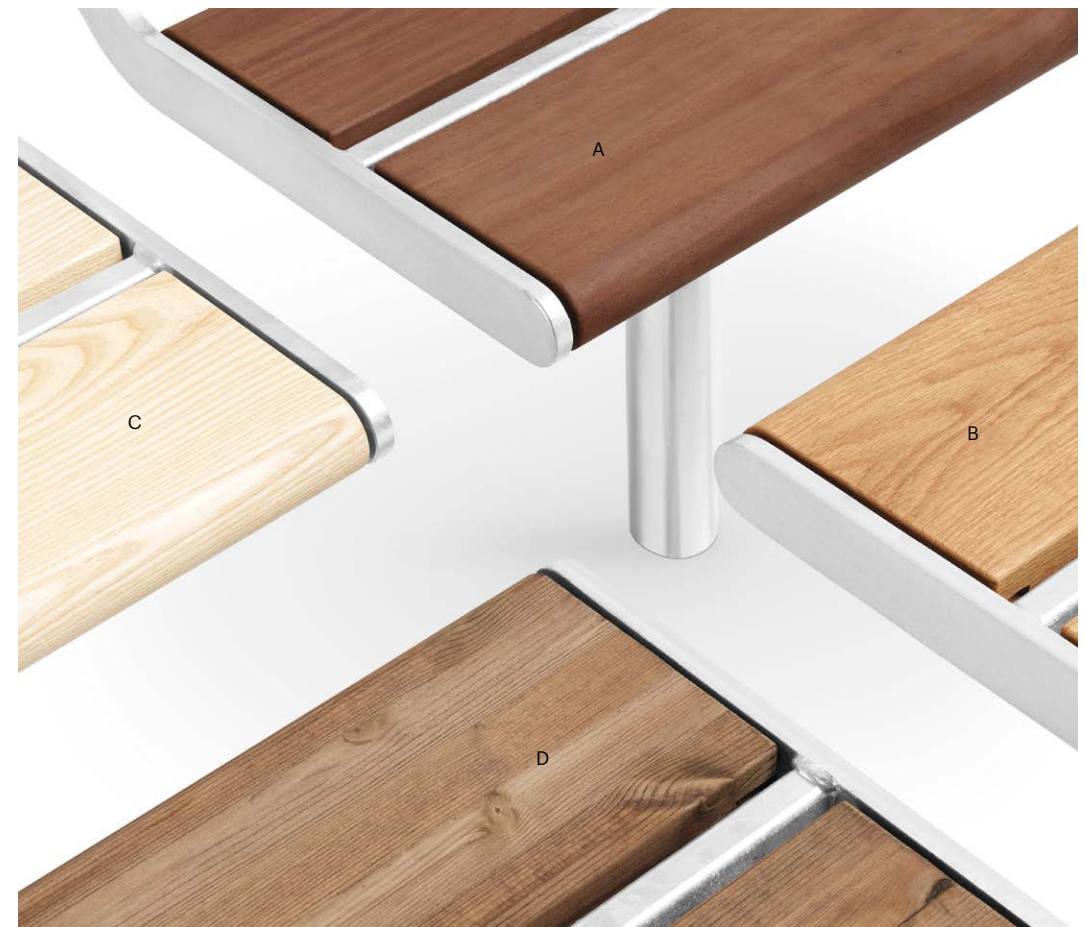

A: Kebony, B: oiled oak, C: oiled ash and D: linseed oil-treated Nordic pine

# Our standard colours

1000	1001	1002	1003	1004	1005	1006	1007	1011	1012
1013	1014	1015	1016	1017	1018	1019	1021	1023	1024
1020	1027	1028	1032	1033	1034	1037	2000	2001	2002
2003	2004	2008	2009	2010	2011	2012	3000	3001	3002
3003	3004	3005	3007	3009	3011	3012	3013	3014	3015
3016	3017	3018	3020	3022	3027	3031	4001	4002	4003
4004	4005	4006	4007	4008	4009	4010	5000	5001	5002
5003	5004	5005	5007	5008	5009	5010	5011	5012	5013
5014	5015	5017	5018	5019	5020	5021	5022	5023	5024
6000	6001	6002	6003	6004	6005	6006	6007	6008	6009

6010	6011	6012	6013	6014	6015	6017	6018	6019	6020
6021	6022	6024	6025	6026	6027	6028	6029	6032	6033
6034	7000	7001	7002	7003	7004	7005	7006	7008	7009
7010	7011	7012	7013	7015	7016	7021	7022	7023	7024
7026	7030	7031	7032	7033	7034	7035	7036	7037	7038
7039	7040	7042	7043	7044	7045	7046	7047	8000	8001
8002	8003	8004	8007	8008	8011	8012	8014	8015	8016
8017	8019	8022	8023	8024	8025	<p>We offer all RAL Classic colours at no extra cost. Our products can also be powder coated in NCS, in other colour systems and with a different gloss level for an additional cost. Please note that not all colours are reproduced correctly on paper</p>			
8028	9001	9002	9001	9004	9005				
9006	9007	9010	9011	9016	9018				

## The Plus

In 2022, Vestre began production at the world's most environmentally-friendly furniture factory, The Plus in Magnor, in the county of Innlandet. The factory is the largest investment in the Norwegian furniture industry for decades and will be a global showcase for sustainability and highly efficient manufacturing. Spectacular architecture, a visitor centre and a 30-hectare (74 acre) adventure park will also help to develop Magnor as an attractive destination for visitors from all over the world. In this way, Vestre will inspire others to take part in the green transition.

"The Plus has a simple x-shaped geometry, whose four wings deftly distribute the building's bulk and constantly reinforce the sense of being immersed in the forest. At the centre of the plus sign, the four wings form an effective logistics hub, which is also a democratic meeting place for employees and visitors that provides maximum transparency."

**Bjarke Ingels,**  
Founding Partner,  
**Viktoria Millentrup,**  
Design Lead Architect, **BIG**





"The Plus is conceived as a village, guided by principles of sustainable architecture and high-efficiency production."

Wallpaper

"The Plus is the greenest, most transparent furniture factory in the world – and you are invited to experience it. Vestre and BIG have reimagined the factory as a hub for jobs, tourism and social gatherings."

Fast Company



**The Plus** has been designed by Bjarke Ingels Group (BIG) in Copenhagen, Denmark. Together, we have created an entirely new typology, where people, production, technology, architecture and nature are completely integrated with each other.

The Plus is the first furniture factory in the world and the first industrial project in Scandinavia to achieve BREEAM Outstanding certification. This is the highest level of environmental certification, and the factory is 'Paris Proof': compared to an equivalent conventional factory, we will reduce greenhouse gas emissions by over 55% and supplied energy needs by over 90%. This is possible through Industry 4.0 technology such as powder coating robots with object recognition, intelligent scanners and big data.

Our goal has not just been to build the world's most environmentally-friendly furniture factory, but also the world's most open

and transparent factory. The Plus is open to anyone who wants to visit the factory, and The Forest Camp park area surrounding the factory building features activities and nature trails that guide visitors to the green roof. In this way, we hope to create increased interest in the industry, technology and sustainable production. Visitors will also have access to the Vestre Energy Center and the Vestre Clean Water Center, where they can learn about energy production, energy recovery, water treatment and the lifecycles of the materials we use. At The Plus, there won't be any fences, boundaries or secrecy – an homage to allemannsretten, or the freedom to roam. We believe that it is through sharing that we can drive the world forward.

*You can read more about the factory, the visitor centre and The Forest Camp at [theplus.no](http://theplus.no).*

# Price list and technical information

Every place is unique, so Vestre products can be adapted to suit different surroundings. The scope of our collection – combined with hundreds of different colours and materials – offers enormous flexibility and virtually unlimited choice. We endeavour to accommodate requests for special requirements wherever possible.

All prices are quoted net without VAT and shipping, and apply to standard designs. Furniture comes with linseed oil impregnated pine as standard, unless otherwise stated. Prices and availability are subject to change without notice.

At [vestre.com](http://vestre.com) you will find high-resolution images, installation instructions, illustrations, 3D / BIM models and a 3D configurator for all products.

The product lists use the following system:

**XXX-901:** The product is hot-dip galvanised, which produces a grey finish with permanent rust protection.

**XXX-900:** The product is hot-dip galvanised and then powder-coated in a RAL colour of the customer's choice.

**XXX-902:** The product is made from stainless or acid-resistant steel, giving it an elegant metallic finish.

**XXX-904:** The product is made from aluminium and then powder-coated in a RAL colour of the customer's choice.

**XXX-XXX A:** Anchored by a base plate, which is bolted down.

**XXX-XXX B:** Anchored by means of wall mounting.

**XXX-XXX C:** Anchored by means of concreting in (some products have an optional pre-cast concrete base, which carries an extra charge).

**XXX-XXX D:** Demountable, i.e. the product can be removed temporarily, for instance when clearing snow or for vehicle access.

**XXX-XXX MK:** The product comes without legs, for mounting directly on top of a wall.

**XXX-XXX P:** Seat, back and/or table top in perforated steel.

**XXX-XXX S:** The product swivels (for instance a chair or barstool).

**XXX-XXX K:** Connection module.

**Kg CO2:** The product's carbon footprint is provided in kilogrammes (A1-A3, from raw material to finished product).

**MJ:** The total energy used in production of the product A1-A3.

\* indicates that we have used the environmental values from a similar product.

# ACCEPTOR

## Acceptor 110 recycling

3 x 110 litres

		Kg CO2	MJ
Art. 2192-900	3 450 EUR / 2 950 GBP	277	3 870
Art. 2192-901	2 980 EUR / 2 540 GBP	277	3 870

Weight: 229 kg

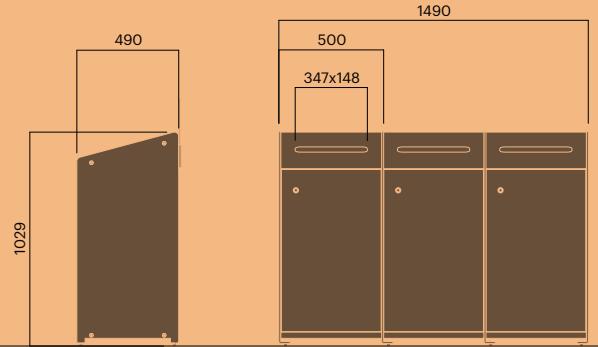

## Acceptor 110 recycling

2 x 55 litres

		Kg CO2	MJ
Art. 2142-900	1 580 EUR / 1 350 GBP	275	3 838
Art. 2142-901	1 340 EUR / 1 150 GBP	275	3 838

Weight: 65 kg

1 x 110 litres

Art. 2144-900	1 580 EUR / 1 350 GBP	278	3 875
Art. 2144-901	1 340 EUR / 1 150 GBP	278	3 875

Weight: 65 kg

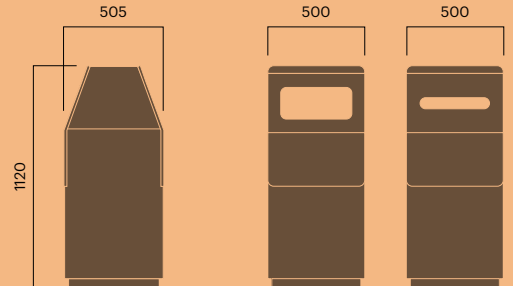

## Acceptor 160 recycling

2 x 160 litres

		Kg CO2	MJ
Art. 2145-900	2 850 EUR / 2 440 GBP	486	6 779
Art. 2145-901	2 350 EUR / 2 010 GBP	486	6 779

Weight: 135 kg

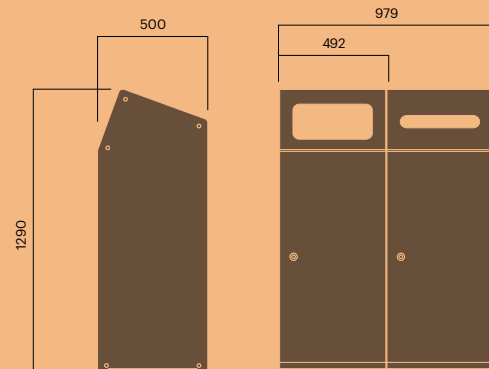

## Acceptor 160 recycling

3 x 160 litres

		Kg CO2	MJ
Art. 2146-900	4 250 EUR / 3 630 GBP	679	9 473
Art. 2146-901	3 580 EUR / 3 050 GBP	679	9 473

Weight: 185 kg

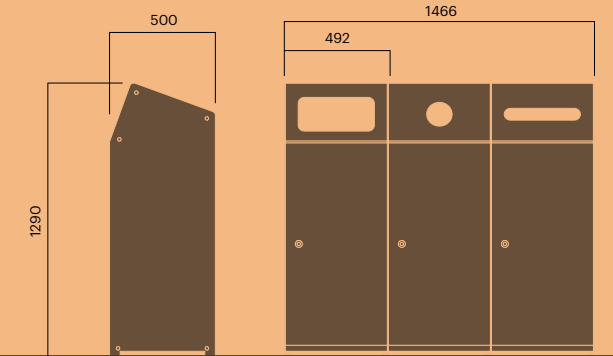

## Acceptor 160 recycling

4 x 160 litres

		Kg CO2	MJ
Art. 2147-900	5 480 EUR / 4 680 GBP	722	10 481
Art. 2147-901	4 780 EUR / 4 080 GBP	722	10 481

Weight: 250 kg

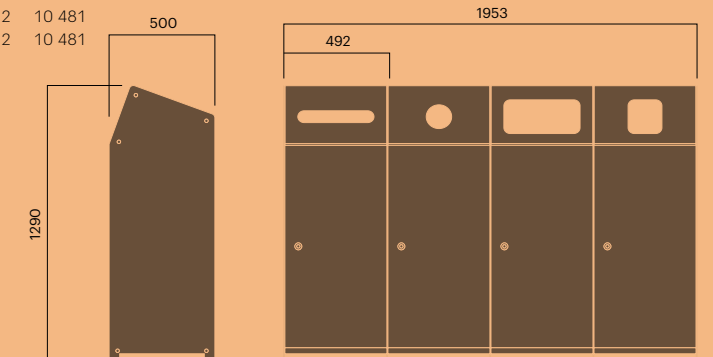

## Acceptor aperture

Choose from various sorting options for Acceptor 160

Weight: 8 kg



# AIR

## Air bench

		Kg CO2	MJ
Art. 3206-900	1 090 EUR / 935 GBP	79	1 536
Art. 3206-901	890 EUR / 760 GBP	79	1 536

Weight: 30 kg

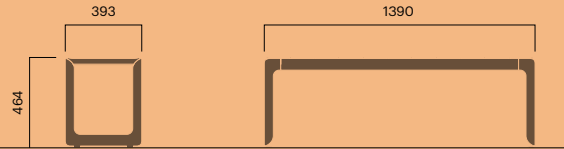

## Air seat

		Kg CO2	MJ
Art. 3217-900	1 980 EUR / 1 690 GBP	171	2 740
Art. 3217-901	1 820 EUR / 1 560 GBP	171	2 740

Weight: 71 kg

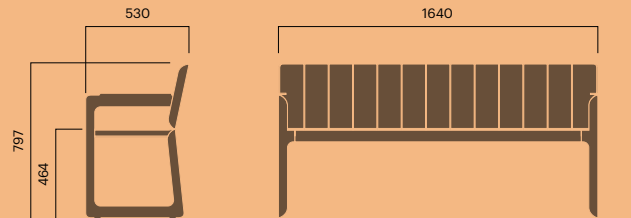

## Air table

		Kg CO2	MJ
Art. 3236-900	1 480 EUR / 1 260 GBP	116	1 901
Art. 3236-901	1 210 EUR / 1 030 GBP	116	1 901

Weight: 51 kg

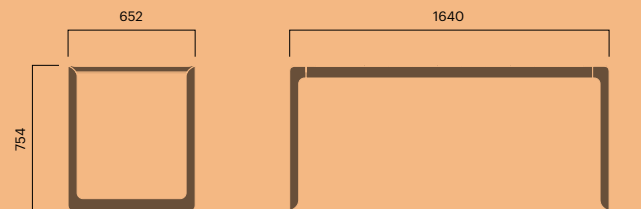

# APRIL

## Anchoring options

- A: anchoring with base plate
- B: wall-mounted
- C: concreting in place
- MK: mounting on wall top

S: swivel function – see technical information  
(+ 140 EUR / 120 GBP)

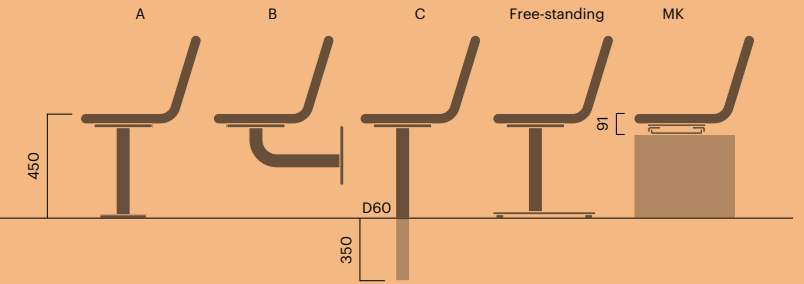

## April armrest

April benches and chairs are available with three different armrests.

Standard armrest

Timber armrest  
e.g. XXX-XXXWO

Universal armrest  
(universal design)  
e.g. XXX-XXX T

100 EUR / 80 GBP  
Weight: 1 kg

Kg CO2: 1  
MJ: 30

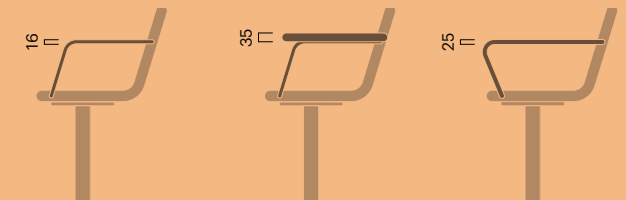

## April perforated steel

April benches, chairs and tables are also available with the back, seat and table top in perforated steel.

e.g. XXX-XXX P

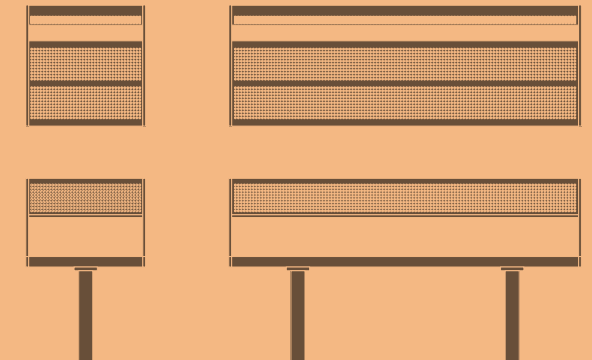

## April chair

Anchoring A, B, C or MK	Kg CO2	MJ
Art. 70-900A	390 EUR / 340 GBP	38 584
Art. 70-901A	350 EUR / 295 GBP	38 584
Art. 70-900B	480 EUR / 410 GBP	38 589
Art. 70-901B	440 EUR / 370 GBP	38 589
Art. 70-900C	380 EUR / 330 GBP	38 594
Art. 70-901C	340 EUR / 285 GBP	38 594
Art. 70-900MK	390 EUR / 340 GBP	26 420
Art. 70-901MK	340 EUR / 290 GBP	26 420

Free-standing	Kg CO2	MJ
Art. 71-900	590 EUR / 500 GBP	57 851
Art. 71-901	490 EUR / 410 GBP	57 851

Weight: 16/17/18 kg

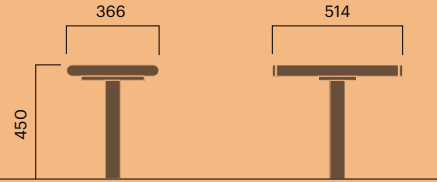

## April chair

Anchoring A, B, C or MK	Kg CO2	MJ
Art. 74-900A	510 EUR / 440 GBP	50* 790*
Art. 74-901A	440 EUR / 380 GBP	50* 790*
Art. 74-900B	590 EUR / 500 GBP	50 790
Art. 74-901B	520 EUR / 440 GBP	50 790
Art. 74-900C	490 EUR / 420 GBP	51 801
Art. 74-901C	420 EUR / 360 GBP	51 801
Art. 74-900MK	480 EUR / 410 GBP	39 631
Art. 74-901MK	420 EUR / 360 GBP	39 631

Free-standing	Kg CO2	MJ
Art. 75-900	690 EUR / 595 GBP	69 1 055
Art. 75-901	610 EUR / 525 GBP	69 1 055

Weight: 20/21/22 kg

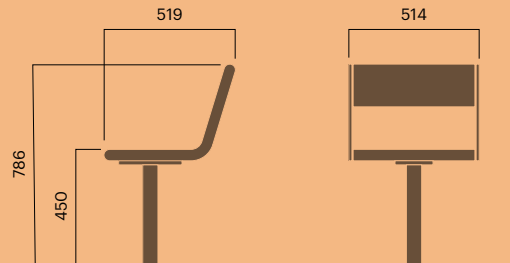

## April chair

Anchoring A, B, C or MK	Kg CO2	MJ
Art. 76-900AT	570 EUR / 490 GBP	69 1 055
Art. 76-901AT	490 EUR / 420 GBP	69 1 055
Art. 76-900BT	660 EUR / 565 GBP	69 1 056
Art. 76-901BT	560 EUR / 480 GBP	69 1 056
Art. 76-900CT	550 EUR / 470 GBP	70 1 069
Art. 76-901CT	480 EUR / 410 GBP	70 1 069
Art. 76-900MKT	550 EUR / 470 GBP	45 725
Art. 76-901MKT	470 EUR / 400 GBP	45 725

Free-standing	Kg CO2	MJ
Art. 77-900T	770 EUR / 655 GBP	76 1 154
Art. 77-901T	660 EUR / 565 GBP	76 1 154

Weight: 23/27/29 kg

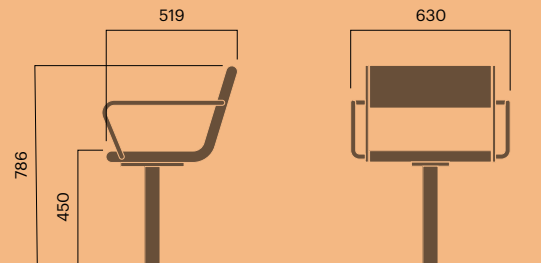

## April bar chair

Anchoring A or C	Kg CO2	MJ
Art. 78-900A	760 EUR / 645 GBP	70 1 085
Art. 78-901A	710 EUR / 605 GBP	70 1 085
Art. 78-900C	740 EUR / 635 GBP	71 1 100
Art. 78-901C	690 EUR / 595 GBP	71 1 100

Free-standing	Kg CO2	MJ
Art. 78-900	1 090 EUR / 935 GBP	129 1 902
Art. 78-901	1 020 EUR / 870 GBP	129 1 902

Weight: 28/47 kg

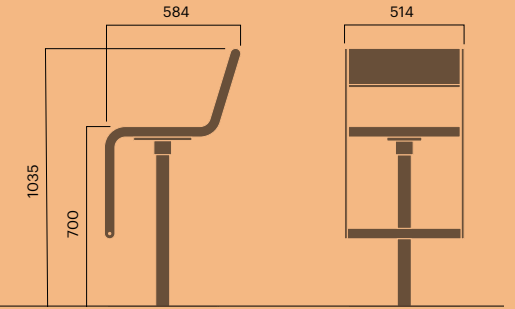

## April bar chair

Anchoring A or C	Kg CO2	MJ
Art. 79-900AT	910 EUR / 780 GBP	38 584
Art. 79-901AT	790 EUR / 675 GBP	38 584
Art. 79-900CT	890 EUR / 760 GBP	38 594
Art. 79-901CT	770 EUR / 655 GBP	38 594

Free-standing	Kg CO2	MJ
Art. 79-900T	1 180 EUR / 1 000 GBP	125 1 845
Art. 79-901T	1 060 EUR / 900 GBP	125 1 845

Weight: 27/40 kg

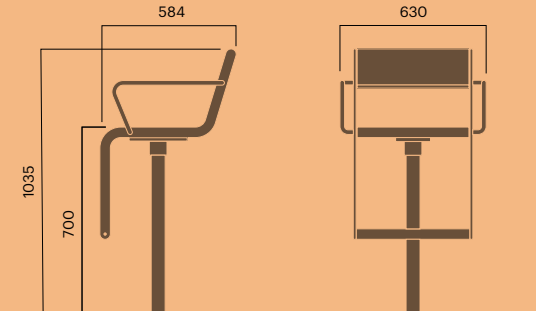

## April chair high back

Without armrest, anchoring A or C	Kg CO2	MJ
Art. 763-900A	870 EUR / 750 GBP	71 1 244
Art. 763-901A	780 EUR / 665 GBP	71 1 244
Art. 763-900C	850 EUR / 730 GBP	73 1 267
Art. 763-901C	760 EUR / 645 GBP	73 1 267

With armrest, anchoring A or C	Kg CO2	MJ
Art. 764-900AT	1 080 EUR / 925 GBP	91 1 520
Art. 764-901AT	980 EUR / 840 GBP	91 1 520
Art. 764-900CT	1 060 EUR / 900 GBP	93 1 544
Art. 764-901CT	960 EUR / 820 GBP	93 1 544

Weight: 29/31 kg

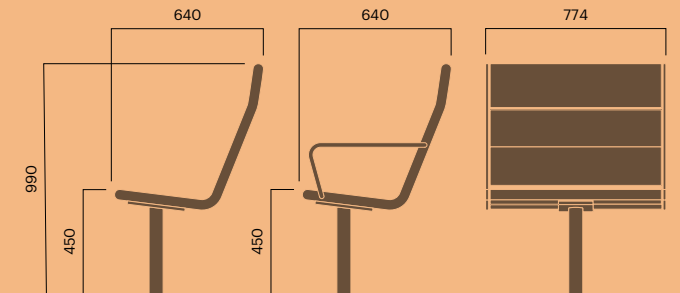

## April bench

Anchoring A, B, C or MK		Kg CO2	MJ
Art. 703-900A	670 EUR / 575 GBP	67	1 134
Art. 703-901A	570 EUR / 490 GBP	67	1 134
Art. 703-900B	760 EUR / 645 GBP	70	1 170
Art. 703-901B	660 EUR / 565 GBP	70	1 170
Art. 703-900C	630 EUR / 545 GBP	69	1 162
Art. 703-901C	530 EUR / 450 GBP	69	1 162
Art. 703-900MK	590 EUR / 500 GBP	44	810
Art. 703-901MK	510 EUR / 440 GBP	44	810

Free-standing			
Art. 706-900	780 EUR / 665 GBP	76	1 260
Art. 706-901	680 EUR / 585 GBP	76	1 260

Weight: 33/36 kg

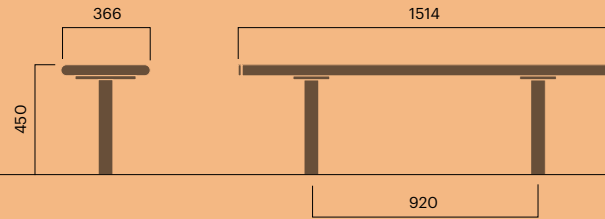

## April bench

Anchoring A, B, C or MK		Kg CO2	MJ
Art. 704-900AT	980 EUR / 840 GBP	77	1 265
Art. 704-901AT	840 EUR / 720 GBP	77	1 265
Art. 704-900BT	1 090 EUR / 935 GBP	79	1 303
Art. 704-901BT	970 EUR / 830 GBP	79	1 303
Art. 704-900CT	940 EUR / 800 GBP	99	1 579
Art. 704-901CT	800 EUR / 685 GBP	99	1 579
Art. 704-900MKT	950 EUR / 810 GBP	53	941
Art. 704-901MKT	810 EUR / 700 GBP	53	941

Free-standing			
Art. 707-900T	1 090 EUR / 935 GBP	86	1 396
Art. 707-901T	990 EUR / 850 GBP	86	1 396

Weight: 36/40 kg

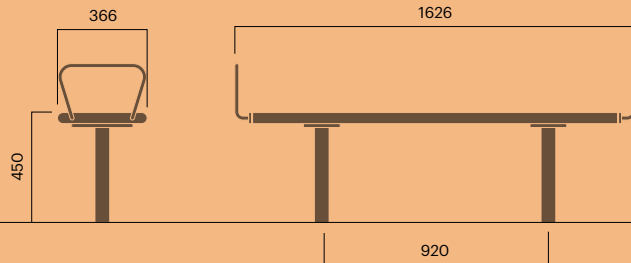

## April seat

Anchoring A, B, C or MK		Kg CO2	MJ
Art. 713-900A	830 EUR / 705 GBP	83	1 446
Art. 713-901A	700 EUR / 595 GBP	83	1 446
Art. 713-900B	970 EUR / 830 GBP	83	1 456
Art. 713-901B	810 EUR / 695 GBP	83	1 456
Art. 713-900C	790 EUR / 675 GBP	84	1 470
Art. 713-901C	660 EUR / 565 GBP	84	1 470
Art. 713-900MK	770 EUR / 655 GBP	51	799
Art. 713-901MK	640 EUR / 545 GBP	51	799

Free-standing			
Art. 716-900	920 EUR / 790 GBP	96	1 629
Art. 716-901	790 EUR / 675 GBP	96	1 629

Weight: 41/42/45 kg

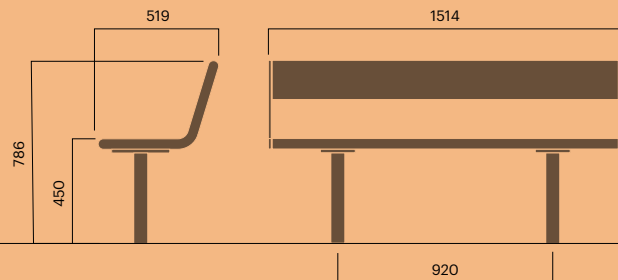

## April seat

Anchoring A, B, C or MK		Kg CO2	MJ
Art. 714-900AT	920 EUR / 790 GBP	89	1 535
Art. 714-901AT	780 EUR / 665 GBP	89	1 535
Art. 714-900BT	1 020 EUR / 870 GBP	106	1 774
Art. 714-901BT	860 EUR / 740 GBP	106	1 774
Art. 714-900CT	880 EUR / 750 GBP	91	1 559
Art. 714-901CT	740 EUR / 635 GBP	91	1 559
Art. 714-900MKT	830 EUR / 705 GBP	59	1 118
Art. 714-901MKT	690 EUR / 595 GBP	59	1 118

Free-standing			
Art. 717-900T	980 EUR / 840 GBP	102	1 719
Art. 717-901T	860 EUR / 740 GBP	102	1 719

Weight: 43/44/47 kg

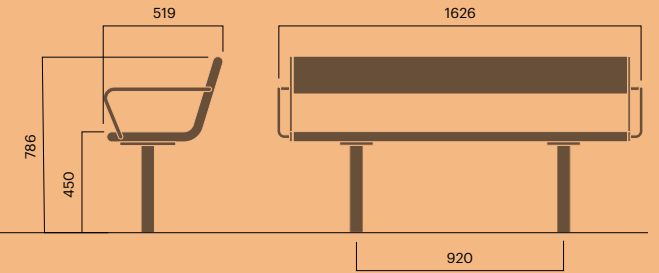

## April picnic table

Without backrests		Kg CO2	MJ
Art. 751-900	2 350 EUR / 1 960 GBP	311	4 909
Art. 751-901	2 110 EUR / 1 760 GBP	311	4 909

Backrest both sides			
Art. 752-900	2 960 EUR / 2 470 GBP	339	5 631
Art. 752-901	2 460 EUR / 2 050 GBP	339	5 631

Backrest one side			
Art. 753-900	2 650 EUR / 2 210 GBP	326	5 412
Art. 753-901	2 290 EUR / 1 910 GBP	326	5 412

Backrest 1 side and adapted for wheelchair			
752-900H	2 990 EUR / 2 490 GBP	344	5 794
752-901H	2 490 EUR / 2 080 GBP	344	5 794

Weight: 126 kg

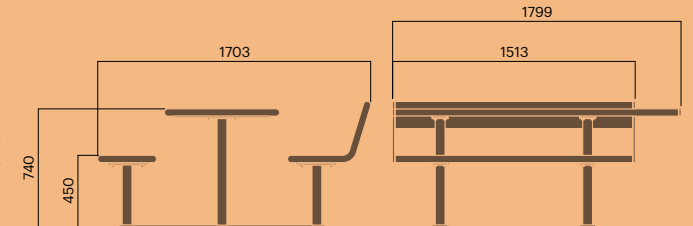

## April Stavanger bench

Anchoring A, B, C or MK		Kg CO2	MJ
Art. 720-900A	720 EUR / 615 GBP	72*	1 204*
Art. 720-901A	620 EUR / 535 GBP	72*	1 204*
Art. 720-900B	790 EUR / 675 GBP	72	1 204
Art. 720-901B	690 EUR / 595 GBP	72	1 204
Art. 720-900C	680 EUR / 585 GBP	72	1 204
Art. 720-901C	580 EUR / 490 GBP	72	1 204
Art. 720-900MK	650 EUR / 555 GBP	47	852
Art. 720-901MK	550 EUR / 470 GBP	47	852

Free-standing			
Art. 721-900	830 EUR / 705 GBP	79	1 298
Art. 721-901	730 EUR / 625 GBP	79	1 298

Weight: 34/44 kg

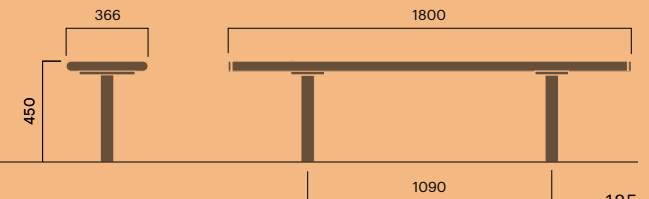

## April Stavanger bench

Anchoring A, B, C or MK		Kg CO2	MJ
Art. 722-900AT	930 EUR / 800 GBP	86	1 406
Art. 722-901AT	840 EUR / 700 GBP	86	1 406
Art. 722-900BT	980 EUR / 840 GBP	88*	1 434*
Art. 722-901BT	890 EUR / 760 GBP	88*	1 434*
Art. 722-900CT	890 EUR / 760 GBP	88	1 434
Art. 722-901CT	800 EUR / 685 GBP	88	1 434
Art. 722-900MKT	870 EUR / 750 GBP	55	974
Art. 722-901MKT	800 EUR / 680 GBP	55	974

Free-standing		Kg CO2	MJ
Art. 722-900T	1 060 EUR / 880 GBP	88*	1 434*
Art. 722-901T	960 EUR / 800 GBP	88*	1 434*

Weight: 36/50 kg

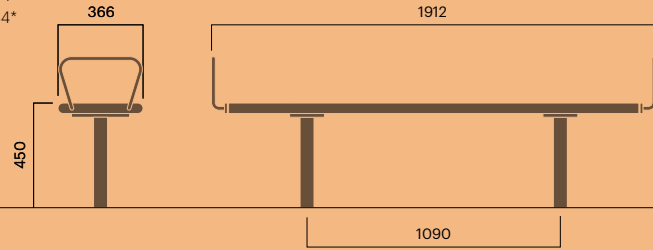

## April Stavanger seat

Anchoring A, B, C or MK		Kg CO2	MJ
Art. 723-900A	920 EUR / 790 GBP	86	1 553
Art. 723-901A	780 EUR / 665 GBP	86	1 553
Art. 723-900B	1 030 EUR / 880 GBP	87	1 557
Art. 723-901B	880 EUR / 750 GBP	87	1 557
Art. 723-900C	880 EUR / 750 GBP	88	1 576
Art. 723-901C	740 EUR / 635 GBP	88	1 576
Art. 723-900MK	830 EUR / 710 GBP	63	1 224
Art. 723-901MK	720 EUR / 615 GBP	63	1 224

Free-standing		Kg CO2	MJ
Art. 726-900	990 EUR / 850 GBP	99	1 735
Art. 726-901	870 EUR / 750 GBP	99	1 735

Weight: 45/46/49 kg

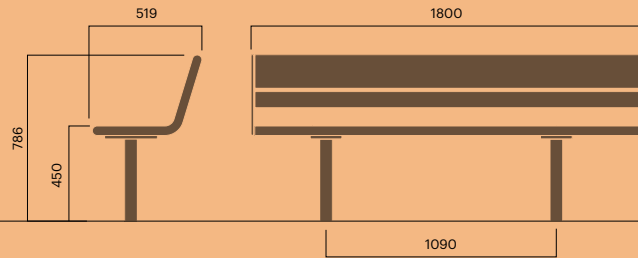

## April Stavanger seat

Anchoring A, B, C or MK		Kg CO2	MJ
Art. 724-900AT	1 060 EUR / 900 GBP	105	1 815
Art. 724-901AT	890 EUR / 760 GBP	105	1 815
Art. 724-900BT	1 120 EUR / 955 GBP	105	1 820
Art. 724-901BT	1 060 EUR / 900 GBP	105	1 820
Art. 724-900CT	1 020 EUR / 870 GBP	107	1 838
Art. 724-901CT	850 EUR / 730 GBP	107	1 838
Art. 724-900MKT	1 020 EUR / 870 GBP	93	1 646
Art. 724-901MKT	850 EUR / 730 GBP	93	1 646

Free-standing		Kg CO2	MJ
Art. 727-900T	1 190 EUR / 1 010 GBP	118	1 998
Art. 727-901T	1 050 EUR / 900 GBP	118	1 998

Weight: 51/52/70 kg

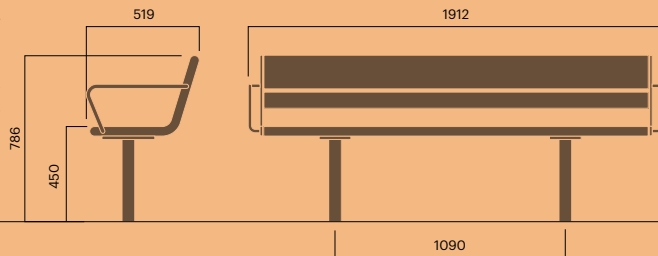

## April April Stavanger picnic table

Without backrests		Kg CO2	MJ
Art. 755-900	2 690 EUR / 2 240 GBP	317	5 248
Art. 755-901	2 280 EUR / 1 900 GBP	317	5 248

Backrest both sides		Kg CO2	MJ
Art. 756-900	2 980 EUR / 2 480 GBP	341	5 549
Art. 756-901	2 680 EUR / 2 230 GBP	341	5 549

Backrest one side		Kg CO2	MJ
Art. 757-900	2 880 EUR / 2 400 GBP	326	5 230
Art. 757-901	2 580 EUR / 2 150 GBP	326	5 230

Without backrests, child height 350/550		Kg CO2	MJ
Art. 755-900JR	2 590 EUR / 2 160 GBP	317	5 248
Art. 755-901JR	2 180 EUR / 1 820 GBP	317	5 248

Weight: 142 kg

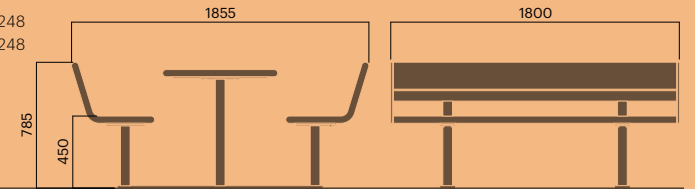

## April sun bench

Anchoring A or C		Kg CO2	MJ
Art. 766-900A	1 560 EUR / 1 330 GBP	149	2 588
Art. 766-901A	1 390 EUR / 1 190 GBP	149	2 588
Art. 766-900C	1 520 EUR / 1 300 GBP	149	2 588
Art. 766-901C	1 350 EUR / 1 160 GBP	149	2 588

Weight: 69/70 kg

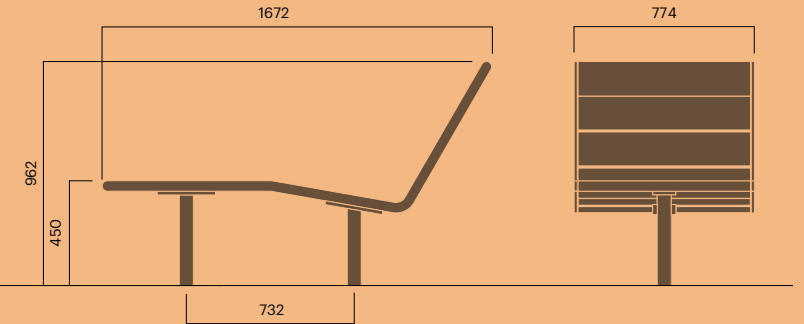

## April seat high back

Anchoring A or C		Kg CO2	MJ
Art. 768-900A	1 320 EUR / 1 130 GBP	102	1 903
Art. 768-901A	1 180 EUR / 1 000 GBP	102	1 903
Art. 768-900C	1 280 EUR / 1 100 GBP	102	1 903
Art. 768-901C	1 140 EUR / 975 GBP	102	1 903

Weight: 56/57 kg

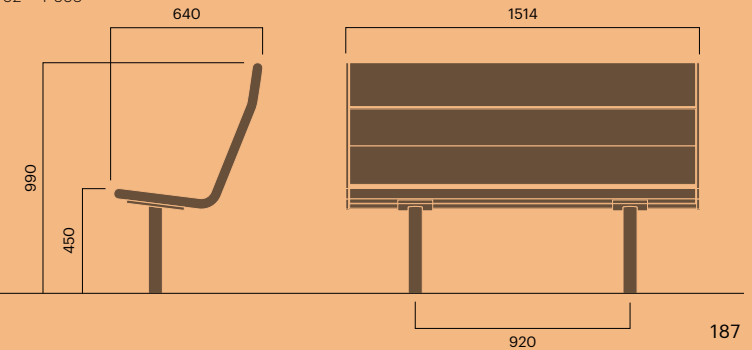

## April seat high back

Anchoring A or C		Kg CO2	MJ
Art. 769-900AT	1 590 EUR / 1 360 GBP	118	2 128
Art. 769-901AT	1 390 EUR / 1 190 GBP	118	2 128
Art. 769-900CT	1 550 EUR / 1 320 GBP	121	2 180
Art. 769-901CT	1 350 EUR / 1 160 GBP	121	2 180

Weight: 62/63 kg

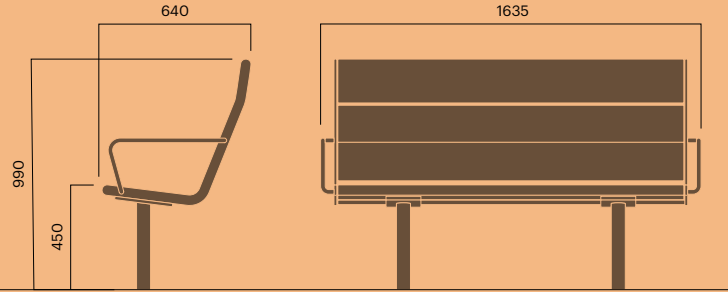

## April steel table

Low, anchoring A or C		Kg CO2	MJ
Art. 732-900A	350 EUR / 300 GBP	50	699
Art. 732-901A	300 EUR / 255 GBP	50	699
Art. 732-900C	330 EUR / 290 GBP	51	713
Art. 732-901C	280 EUR / 235 GBP	51	713

High, anchoring A or C		Kg CO2	MJ
Art. 730-900A	360 EUR / 310 GBP	57	797
Art. 730-901A	300 EUR / 255 GBP	57	797
Art. 730-900C	340 EUR / 290 GBP	59	817
Art. 730-901C	280 EUR / 235 GBP	59	817

Weight: 16/17 kg

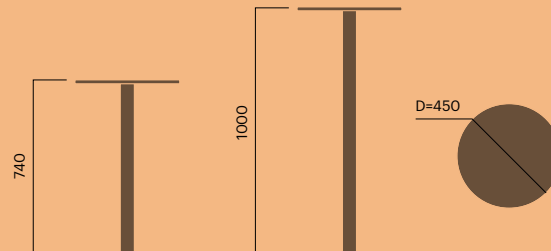

## April round table small

Anchoring A or C		Kg CO2	MJ
Art. 731-900A	810 EUR / 695 GBP	69	1 096
Art. 731-901A	740 EUR / 635 GBP	69	1 096
Art. 731-900C	790 EUR / 675 GBP	70	1 109
Art. 731-901C	720 EUR / 615 GBP	70	1 109

Free-standing		Kg CO2	MJ
Art. 731-900	1 050 EUR / 900 GBP	96	1 467
Art. 731-901	940 EUR / 800 GBP	96	1 467

Weight: 31/45 kg

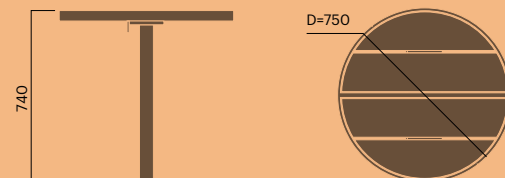

## April round table

Anchoring A or C		Kg CO2	MJ
Art. 737-900A	1 080 EUR / 925 GBP	94	1 610
Art. 737-901A	980 EUR / 840 GBP	94	1 610
Art. 737-900C	1 060 EUR / 900 GBP	95	1 619
Art. 737-901C	960 EUR / 820 GBP	95	1 619

Free-standing		Kg CO2	MJ
Art. 738-900	1 530 EUR / 1 310 GBP	148	2 361
Art. 738-901	1 390 EUR / 1 190 GBP	148	2 361

Weight: 48/66 kg

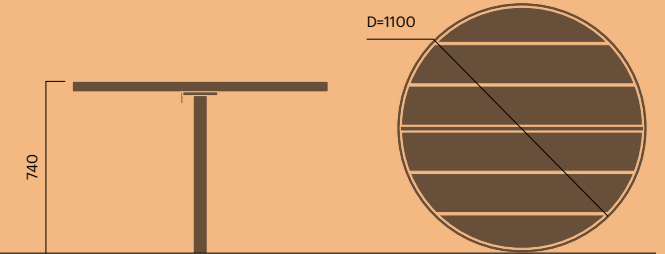

## April short table

Anchoring A or C		Kg CO2	MJ
Art. 734-900A	640 EUR / 545 GBP	66	1 091
Art. 734-901A	560 EUR / 480 GBP	66	1 091
Art. 734-900C	620 EUR / 535 GBP	67	1 100
Art. 734-901C	540 EUR / 460 GBP	67	1 100

Free-standing		Kg CO2	MJ
Art. 735-900	860 EUR / 740 GBP	92	1 457
Art. 735-901	780 EUR / 665 GBP	92	1 457

Weight: 33/38 kg

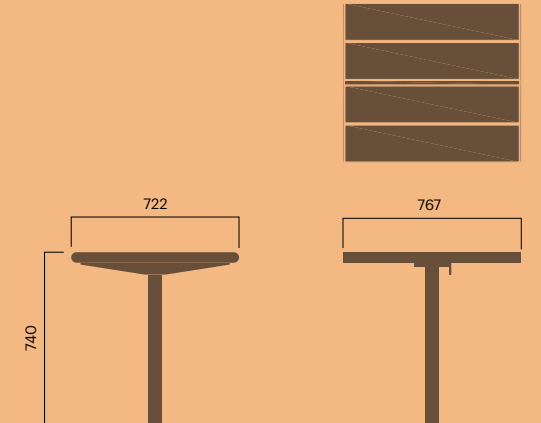

## April standard table

Anchoring A or C		Kg CO2	MJ
Art. 733-900A	990 EUR / 850 GBP	110	1 914
Art. 733-901A	850 EUR / 730 GBP	110	1 914
Art. 733-900C	950 EUR / 810 GBP	111	1 937
Art. 733-901C	810 EUR / 695 GBP	111	1 937

Free-standing		Kg CO2	MJ
Art. 736-900	1 160 EUR / 995 GBP	127	2 158
Art. 736-901	980 EUR / 840 GBP	127	2 158

Weight: 57/85 kg

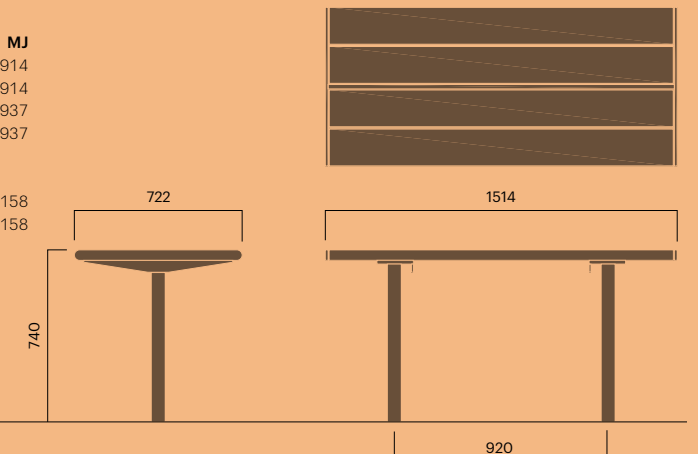



## April table

Adapted for wheelchair

Anchoring A or C		Kg CO2	MJ
Art. 739-900A	1 060 EUR / 900 GBP	112	1 979
Art. 739-901A	890 EUR / 760 GBP	112	1 979
Art. 739-900C	1 020 EUR / 870 GBP	114	2 007
Art. 739-901C	850 EUR / 730 GBP	114	2 007

Free-standing		Kg CO2	MJ
Art. 739-900	1 190 EUR / 1 010 GBP	130	2 227
Art. 739-901	1 010 EUR / 860 GBP	130	2 227

Weight: 60/90 kg

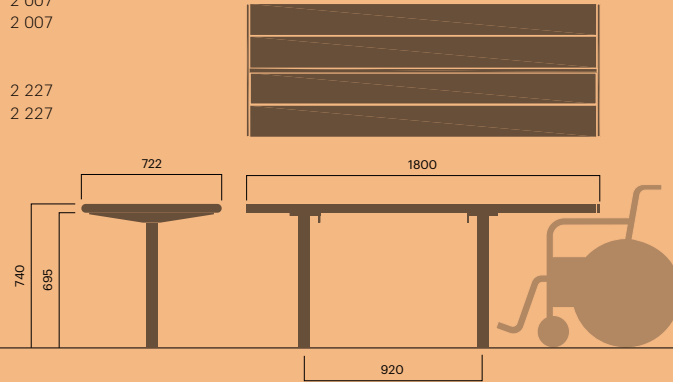

## April Stavanger table

Anchoring A or C		Kg CO2	MJ
Art. 743-900A	990 EUR / 850 GBP	112	1 979
Art. 743-901A	880 EUR / 750 GBP	112	1 979
Art. 743-900C	950 EUR / 810 GBP	114	2 003
Art. 743-901C	840 EUR / 720 GBP	114	2 003

Free-standing		Kg CO2	MJ
Art. 746-900	1 160 EUR / 995 GBP	129	2 223
Art. 746-901	990 EUR / 850 GBP	129	2 223

Weight: 60/65 kg

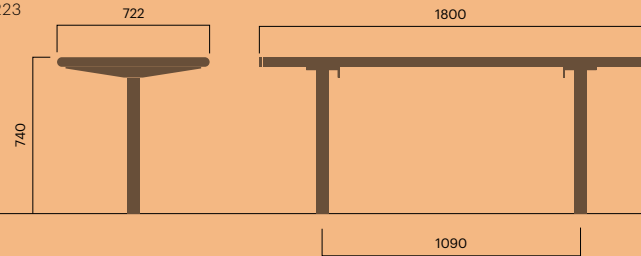

## April bar table

		Kg CO2	MJ
Art. 741-900A	850 EUR / 730 GBP	97	1 632
Art. 741-901A	740 EUR / 630 GBP	97	1 632
Art. 741-900C	820 EUR / 700 GBP	98	1 651
Art. 741-901C	710 EUR / 610 GBP	98	1 651

Weight: 42/43 kg

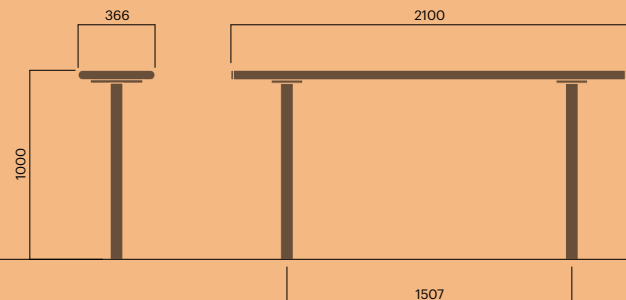

## April litter bin

75 litres

		Kg CO2	MJ
Art. 770-900	1 580 EUR / 1 350 GBP	184	2 572
Art. 770-901	1 420 EUR / 1 210 GBP	184	2 572

95 litres

Art. 772-900	1 680 EUR / 1 440 GBP	237	3 307
Art. 772-901	1 520 EUR / 1 300 GBP	237	3 307

Weight: 59/69 kg

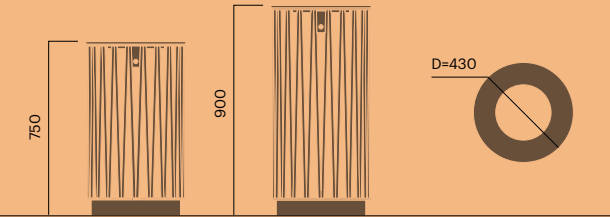

## April litter bin

145 litres

		Kg CO2	MJ
Art. 774-900	1 820 EUR / 1 560 GBP	180	2 514
Art. 774-901	1 640 EUR / 1 400 GBP	180	2 514

175 litres

Art. 776-900	1 920 EUR / 1 640 GBP	325	4 541
Art. 776-901	1 750 EUR / 1 500 GBP	325	4 541

Weight: 57/102 kg

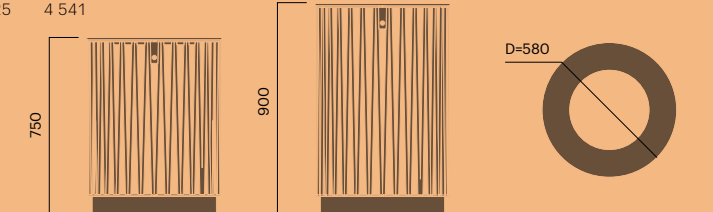

## April litter bin

75 litres

		Kg CO2	MJ
Art. 780-900	1 180 EUR / 1 000 GBP	112	1 570
Art. 780-901	990 EUR / 850 GBP	112	1 570

95 litres

Art. 782-900	1 290 EUR / 1 110 GBP	128	1 791
Art. 782-901	1 090 EUR / 935 GBP	128	1 791

Weight: 35/40 kg

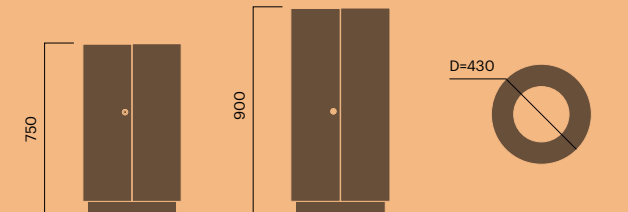

## April litter bin

145 litres

		Kg CO2	MJ
Art. 784-900	1 480 EUR / 1 260 GBP	154	2 153
Art. 784-901	1 280 EUR / 1 100 GBP	154	2 153

175 litres

Art. 786-900	1 660 EUR / 1 420 GBP	176	2 450
Art. 786-901	1 420 EUR / 1 210 GBP	176	2 450

Weight: 48/68 kg

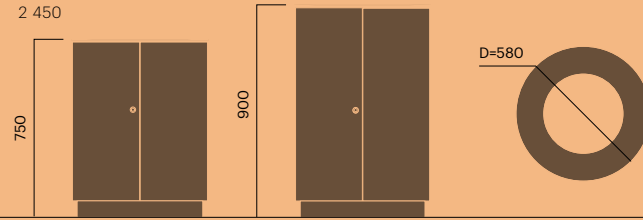

## APRIL GO

### April Go chair

Seat and back in wood		Kg CO2	MJ
Art. 7013-900	420 EUR / 360 GBP	30	448
Art. 7013-901	360 EUR / 305 GBP	30	448

Seat and back in powder-coated aluminium

Art. 7013-330	390 EUR / 340 GBP	37	553
Art. 7013-331	360 EUR / 305 GBP	37	553

Weight: 12/13 kg

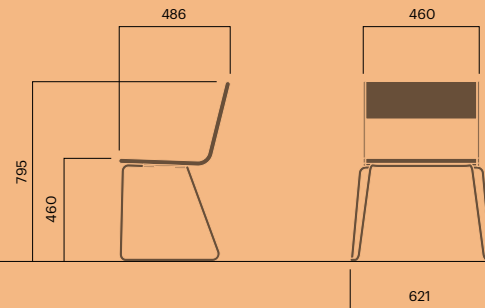

### April Go chair

With armrest, seat and back in wood		Kg CO2	MJ
Art. 7014-900	530 EUR / 450 GBP	33	500
Art. 7014-901	480 EUR / 410 GBP	33	500

With armrest, seat and back in powder-coated aluminium

Art. 7014-330	520 EUR / 440 GBP	40	612
Art. 7014-331	470 EUR / 400 GBP	40	612

Weight: 13/14 kg

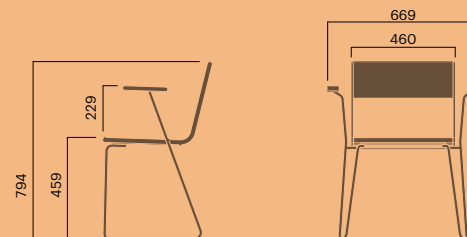

## April Go lounge chair

Seat and back in wood		Kg CO2	MJ
Art. 7064-900	510 EUR / 430 GBP	32	485
Art. 7064-901	420 EUR / 350 GBP	32	485

Weight: 14 kg

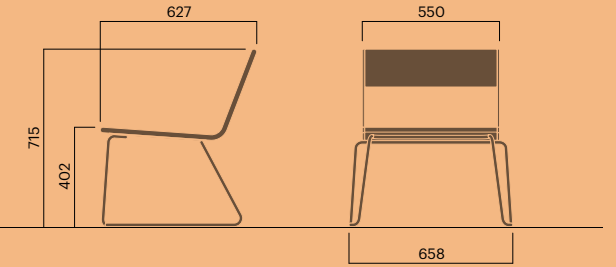

## April Go bar chair

Seat and back in wood		Kg CO2	MJ
Art. 7018-900	490 EUR / 410 GBP	32	475
Art. 7018-901	430 EUR / 360 GBP	32	475

Weight: 11 kg

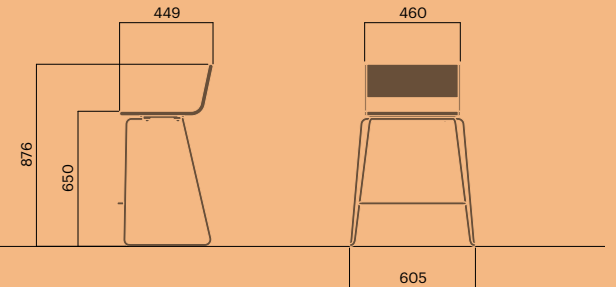

## April Go bench

Seat in wood		Kg CO2	MJ
Art. 7006-900	550 EUR / 470 GBP	36	572
Art. 7006-901	480 EUR / 410 GBP	36	572

Weight: 15 kg

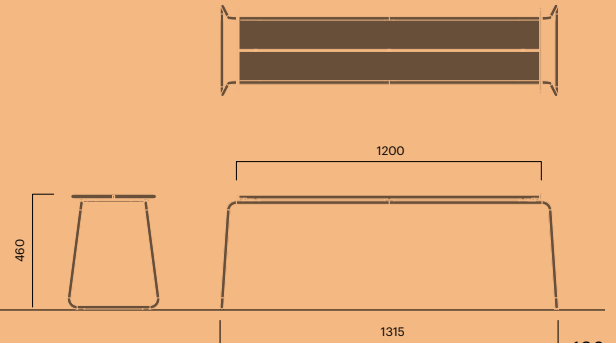

### April Go seat

Seat and back in wood		Kg CO2	MJ
Art. 7015-900	710 EUR / 605 GBP	44	708
Art. 7015-901	610 EUR / 525 GBP	44	708

Seat and back in powder-coated aluminium		Kg CO2	MJ
Art. 7015-330	660 EUR / 565 GBP	60	922
Art. 7015-331	550 EUR / 470 GBP	60	922

With armrest, seat and back in wood		Kg CO2	MJ
Art. 7016-900	850 EUR / 730 GBP	47	760
Art. 7016-901	750 EUR / 645 GBP	47	760

Weight: 22/25/23 kg

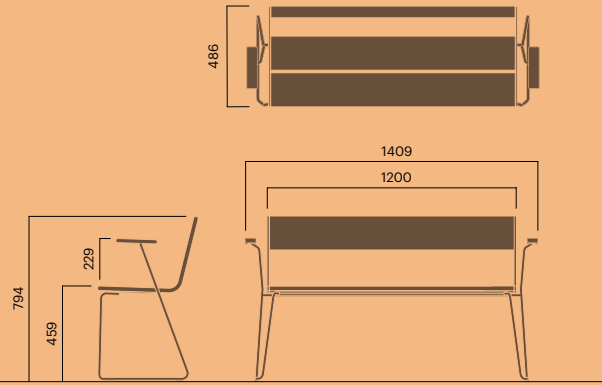

### April Go folding table

Table top in wood		Kg CO2	MJ
Art. 7033-900	690 EUR / 595 GBP	38	503
Art. 7033-901	650 EUR / 555 GBP	38	503

Table top in powder-coated aluminium		Kg CO2	MJ
Art. 7033-330	790 EUR / 675 GBP	50	777
Art. 7033-331	740 EUR / 635 GBP	50	777

Weight: 15/16 kg

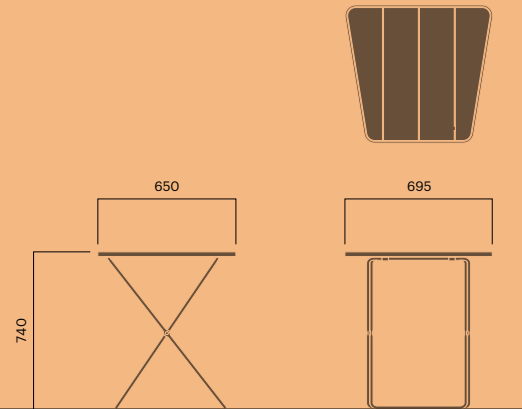

### April Go rectangular folding table

		Kg CO2	MJ
Art. 7036-900	1 040 EUR / 890 GBP	64	1 198
Art. 7036-901	850 EUR / 730 GBP	64	1 198

Weight: 36 kg

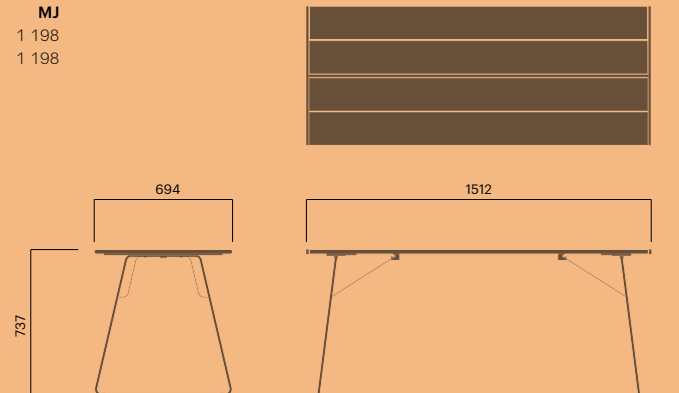

### April Go round folding table

		Kg CO2	MJ
Art. 7037-900	980 EUR / 840 GBP	47	752
Art. 7037-901	850 EUR / 730 GBP	47	752

Weight: 26 kg

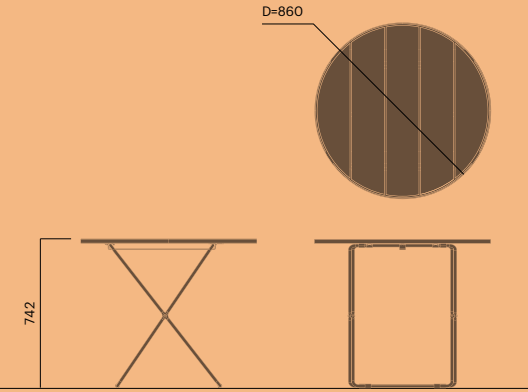

### April Go lounge table

		Kg CO2	MJ
Art. 7030-900	480 EUR / 400 GBP	32	475
Art. 7030-901	420 EUR / 350 GBP	32	475

Weight: 16 kg



### April Go planter

H390/D650, 100 L		Kg CO2	MJ
Art. 7080-900	790 EUR / 660 GBP	86	1 202
Art. 7080-901	710 EUR / 590 GBP	86	1 202

H570/D650, 150 L		Kg CO2	MJ
Art. 7081-900	850 EUR / 730 GBP	131	1 818
Art. 7081-901	750 EUR / 645 GBP	131	1 818

H790/D650, 210 L		Kg CO2	MJ
Art. 7082-900	980 EUR / 840 GBP	162	2 257
Art. 7082-901	870 EUR / 750 GBP	162	2 257

Weight: 29/40/60 kg

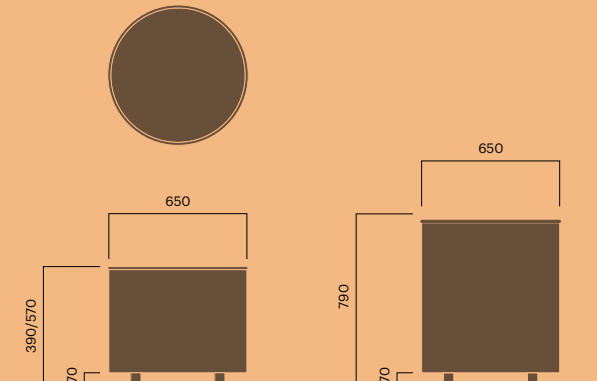

## April Go planter

		Kg CO2	MJ
<b>H390/D900, 150 L</b>			
Art. 7083-900	880 EUR / 750 GBP	165	2 300
Art. 7083-901	780 EUR / 665 GBP	165	2 300
<b>H570/D900, 300 L</b>			
Art. 7084-900	1 070 EUR / 910 GBP	201	2 806
Art. 7084-901	840 EUR / 720 GBP	201	2 806
<b>H840/D900, 460 L</b>			
Art. 7085-900	1 540 EUR / 1 310 GBP	220	3 069
Art. 7085-901	1 420 EUR / 1 180 GBP	220	3 069

		Kg CO2	MJ
<b>H940/D1200, 800L</b>			
Art. 7087-900	2 480 EUR / 2 070 GBP	498	6 930
Art. 7087-901	2 210 EUR / 1 840 GBP	498	6 930

Weight: 40/60/84/148 kg

Other sizes available on request

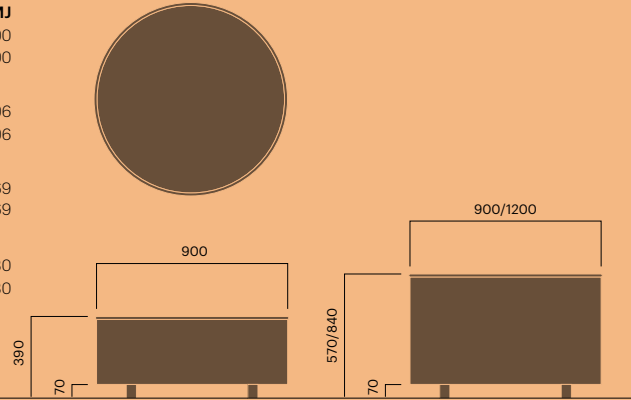

## Atlas double seat

		Kg CO2	MJ
Art. 4527-900	5 480 EUR / 4 570 GBP	589	9 283
Art. 4527-901	5 150 EUR / 4 290 GBP	589	9 283

### With 2 armrests

Art. 4528-900	5 920 EUR / 4 930 GBP	620	9 710
Art. 4528-901	5 460 EUR / 4 550 GBP	620	9 710

Weight: 240/250 kg

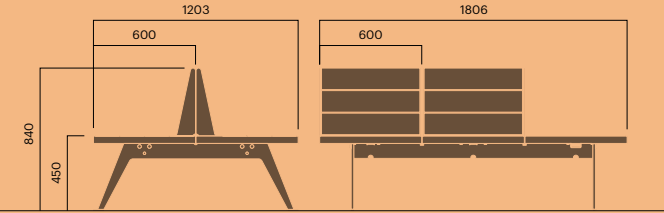

# ATLAS

## Atlas bench

		Kg CO2	MJ
<b>2-seater</b>			
Art. 4502-900	1 570 EUR / 1 310 GBP	159	2 007
Art. 4502-901	1 320 EUR / 1 100 GBP	159	2 007
<b>3-seater</b>			
Art. 4503-900	2 150 EUR / 1 790 GBP	225	3 394
Art. 4503-901	1 820 EUR / 1 520 GBP	225	3 394

		Kg CO2	MJ
<b>4-seater</b>			
Art. 4504-900	2 780 EUR / 2 320 GBP	290	4 392
Art. 4504-901	2 360 EUR / 1 970 GBP	290	4 392

Weight: 70/100/130 kg

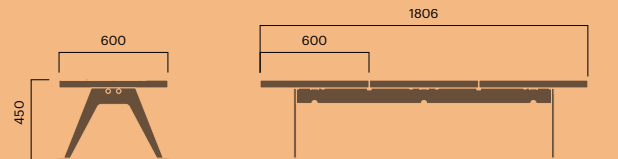

## Atlas frame

		Kg CO2	MJ
<b>Frame 2-seater</b>			
Art. 4550-900	590 EUR / 490 GBP	101	1 407
Art. 4550-901	480 EUR / 400 GBP	101	1 407

		Kg CO2	MJ
<b>Frame 3-seater</b>			
Art. 4551-900	680 EUR / 570 GBP	131	1 864
Art. 4551-901	560 EUR / 480 GBP	131	1 864

		Kg CO2	MJ
<b>Frame 4-seater</b>			
Art. 4552-900	820 EUR / 695 GBP	165	2 296
Art. 4552-901	680 EUR / 585 GBP	165	2 296

Weight: 30/40/50 kg

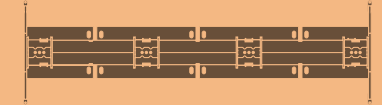

## Atlas seat

		Kg CO2	MJ
<b>2-seater</b>			
Art. 4512-900	2 280 EUR / 1 900 GBP	235	3 725
Art. 4512-901	2 100 EUR / 1 750 GBP	235	3 725
<b>3-seater</b>			
Art. 4513-900	3 200 EUR / 2 670 GBP	198	2 982
Art. 4513-901	2 990 EUR / 2 490 GBP	198	2 982

		Kg CO2	MJ
<b>4-seater</b>			
Art. 4514-900	4 180 EUR / 3 480 GBP	434	6 937
Art. 4514-901	3 920 EUR / 3 270 GBP	434	6 937

Weight: 90/133/174 kg

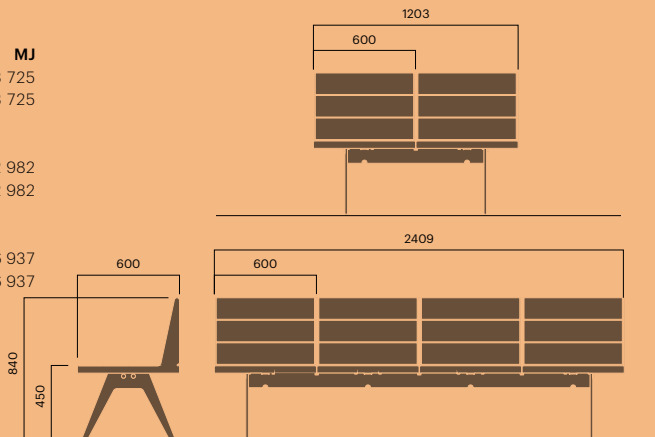

## Atlas frame

		Kg CO2	MJ
<b>Frame 4-seater (2+2)</b>			
Art. 4560-900	980 EUR / 840 GBP	193	2 697
Art. 4560-901	860 EUR / 740 GBP	193	2 697

		Kg CO2	MJ
<b>Frame 6-seater (3+3)</b>			
Art. 4561-900	1 240 EUR / 1 060 GBP	258	3 593
Art. 4561-901	1 020 EUR / 870 GBP	258	3 593

Weight: 55/77 kg

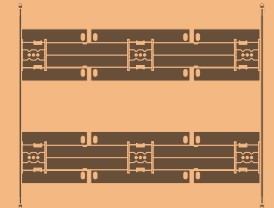

## Atlas seat pan

Seat without back		Kg CO2	MJ
Art. 4520-900	<b>490 EUR / 410 GBP</b>	31	523
Art. 4520-901	<b>420 EUR / 350 GBP</b>	31	523

Seat curved		Kg CO2	MJ
Art. 4530-900	<b>980 EUR / 820 GBP</b>	760	1 391
Art. 4530-901	<b>920 EUR / 770 GBP</b>	650	1 391

Weight: 20/34 kg

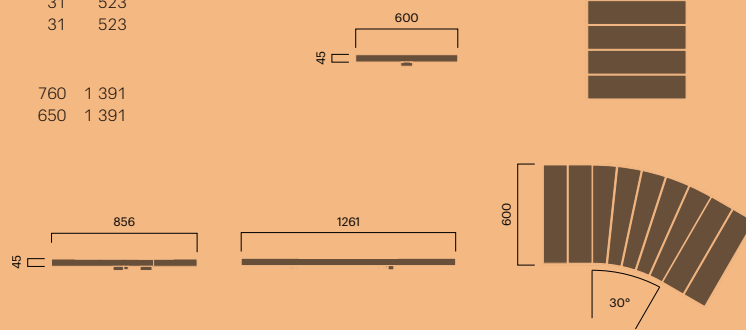

## Atlas seat pan with back

		Kg CO2	MJ
Art. 4521-900	<b>840 EUR / 700 GBP</b>	67	1 157
Art. 4521-901	<b>810 EUR / 680 GBP</b>	67	1 157

With wide armrest  
left (V) or right (H)

Art. 4526-900V	<b>990 EUR / 830 GBP</b>	83	1 392
Art. 4526-901V	<b>920 EUR / 770 GBP</b>	83	1 392
Art. 4526-900H	<b>990 EUR / 830 GBP</b>	83	1 392
Art. 4526-901H	<b>920 EUR / 770 GBP</b>	83	1 392

Weight: 31/36 kg

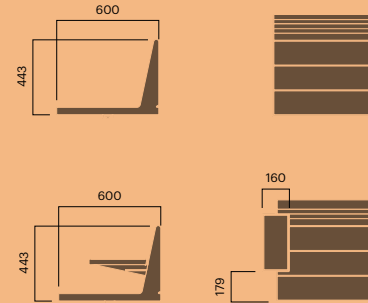

## BERG

### Berg picnic bench table

		Kg CO2	MJ
Art. 322-900	<b>1 550 EUR / 1 320 GBP</b>	106	1 934
Art. 322-901	<b>1 380 EUR / 1 180 GBP</b>	106	1 934

Adapted for wheelchair

Art. 322-900HC	<b>1 640 EUR / 1 400 GBP</b>	136	2 465
Art. 322-901HC	<b>1 460 EUR / 1 250 GBP</b>	136	2 465

Weight: 80/90 kg

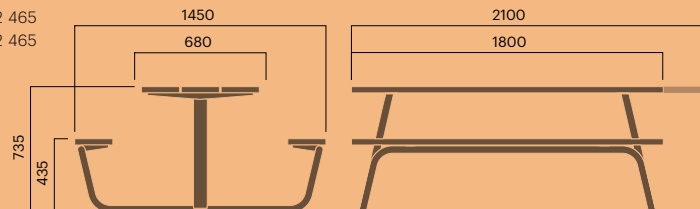

## Berg cycle rack

For 6 bicycles		Kg CO2	MJ
Art. 393-900	<b>790 EUR / 675 GBP</b>	110	1 534
Art. 393-901	<b>690 EUR / 595 GBP</b>	110	1 534

For 8 bicycles		Kg CO2	MJ
Art. 395-900	<b>960 EUR / 820 GBP</b>	150	2 083
Art. 395-901	<b>790 EUR / 675 GBP</b>	150	2 083

Weight: 35/50 kg

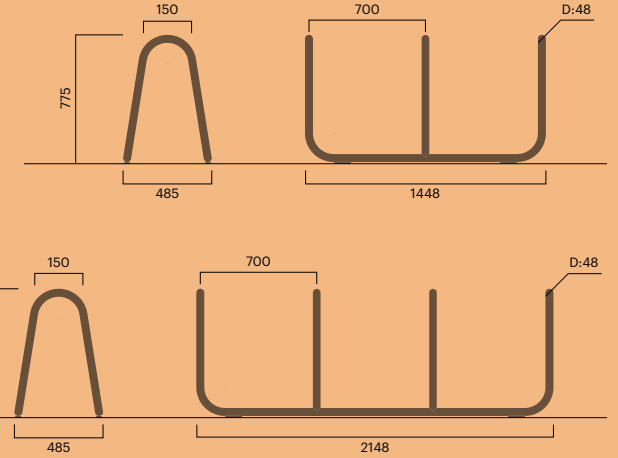

## BERLIN

### Berlin chair

Anchoring A or C		Kg CO2	MJ
Art. 3713-900A	<b>1 120 EUR / 950 GBP</b>	74	1 150
Art. 3713-901A	<b>1 020 EUR / 870 GBP</b>	74	1 150
Art. 3713-900C	<b>1 090 EUR / 935 GBP</b>	77	1 192
Art. 3713-901C	<b>980 EUR / 840 GBP</b>	77	1 192

Anchoring A or C with armrests		Kg CO2	MJ
Art. 3717-900A	<b>1 290 EUR / 1 110 GBP</b>	90	1 371
Art. 3717-901A	<b>1 190 EUR / 1 020 GBP</b>	90	1 371
Art. 3717-900C	<b>1 260 EUR / 1 080 GBP</b>	92	1 398
Art. 3717-901C	<b>1 160 EUR / 995 GBP</b>	92	1 398

Weight: 32/34 kg

swivel function – see technical information  
(+ 140 EUR / 120 GBP)

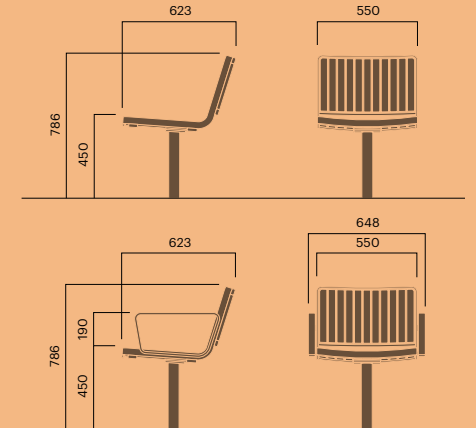

### Berlin chair

Free-standing		Kg CO2	MJ
Art. 3718-900	<b>1 360 EUR / 1 160 GBP</b>	93	1 405
Art. 3718-901	<b>1 250 EUR / 1 070 GBP</b>	93	1 405

Free-standing with armrests		Kg CO2	MJ
Art. 3717-900	<b>1 460 EUR / 1 250 GBP</b>	97	1 464
Art. 3717-901	<b>1 320 EUR / 1 130 GBP</b>	97	1 464

Weight: 34/36 kg

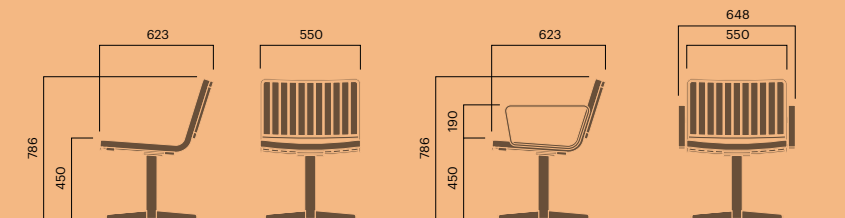

## Berlin table small

Anchoring A or C		Kg CO2	MJ
Art. 3731-900A	590 EUR / 500 GBP	64	896
Art. 3731-901A	490 EUR / 420 GBP	64	896
Art. 3731-900C	570 EUR / 490 GBP	65	905
Art. 3731-901C	470 EUR / 400 GBP	65	905

Free-standing		Kg CO2	MJ
Art. 3731-900	690 EUR / 595 GBP	72	999
Art. 3731-901	590 EUR / 500 GBP	72	999

Weight: 24/30 kg

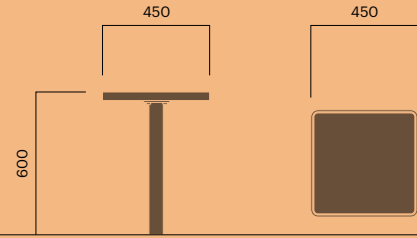

## Berlin table large

Anchoring A or C		Kg CO2	MJ
Art. 3733-900A	890 EUR / 760 GBP	141	1 965
Art. 3733-901A	790 EUR / 675 GBP	141	1 965
Art. 3733-900C	870 EUR / 750 GBP	142	1 975
Art. 3733-901C	770 EUR / 655 GBP	142	1 975

Free-standing		Kg CO2	MJ
Art. 3733-900	990 EUR / 850 GBP	147	2 054
Art. 3733-901	880 EUR / 750 GBP	147	2 054

Weight: 28/35 kg

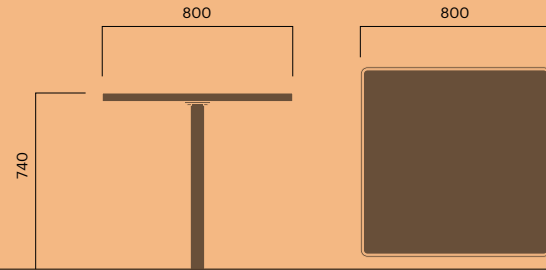

## BLOC

### Bloc chair

		Kg CO2	MJ
Art. 1503-900	1 180 EUR / 1 000 GBP	180	2 672
Art. 1503-901	980 EUR / 840 GBP	180	2 672

With armrests		Kg CO2	MJ
Art. 1504-900	1 290 EUR / 1 110 GBP	199	2 934
Art. 1504-901	1 050 EUR / 900 GBP	199	2 934

Weight: 65/71 kg

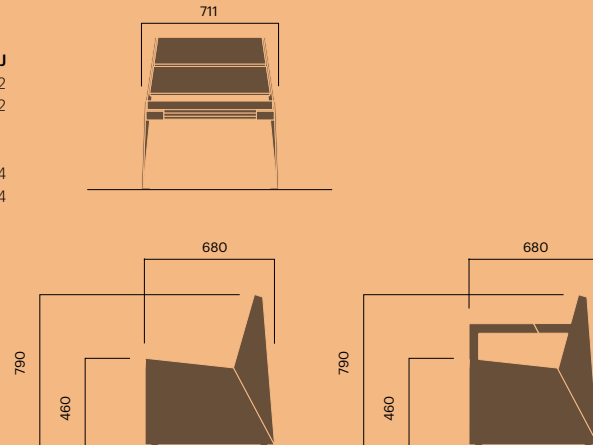

## Bloc bench

		Kg CO2	MJ
Art. 1506-900	1 050 EUR / 900 GBP	145	2 304
Art. 1506-901	920 EUR / 790 GBP	145	2 304

Weight: 60 kg

Start module		Kg CO2	MJ
Art. 1507-900	1 120 EUR / 955 GBP	152	2 398
Art. 1507-901	980 EUR / 840 GBP	152	2 398

Weight: 62 kg

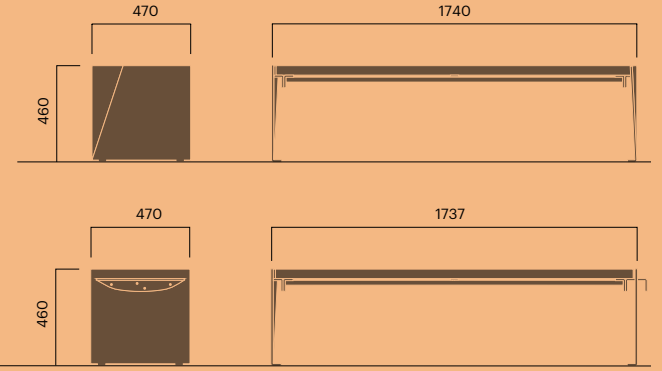

## Bloc bench

Add-on module		Kg CO2	MJ
Art. 1508-900	860 EUR / 740 GBP	99	1 665
Art. 1508-901	760 EUR / 645 GBP	99	1 665

Weight: 45 kg

End module		Kg CO2	MJ
Art. 1509-900	810 EUR / 700 GBP	94	1 590
Art. 1509-901	710 EUR / 605 GBP	94	1 590

Weight: 46 kg

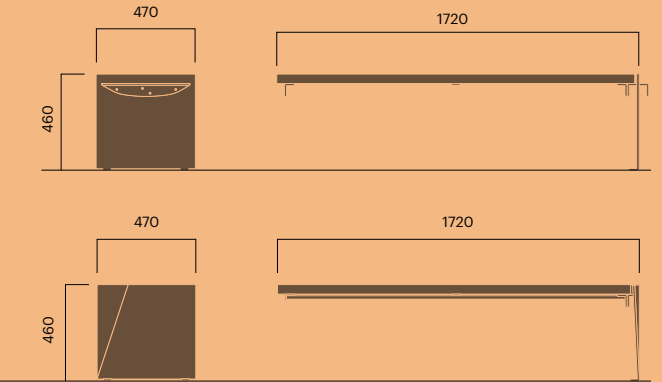

## Bloc seat

		Kg CO2	MJ
Art. 1516-900	1 490 EUR / 1 270 GBP	201	3 273
Art. 1516-901	1 230 EUR / 1 060 GBP	201	3 273

Weight: 88 kg

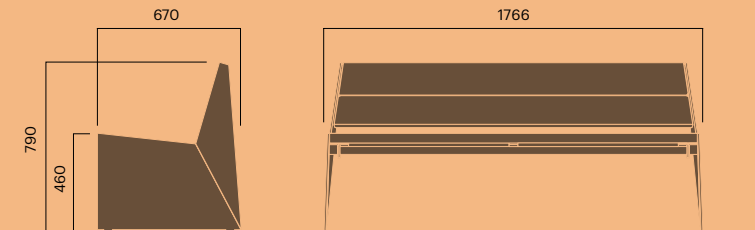

### Bloc seat start module

		Kg CO2	MJ
Art. 1553-900	1 590 EUR / 1 360 GBP	209	3 374
Art. 1553-901	1 340 EUR / 1 150 GBP	209	3 374

Weight: 89 kg

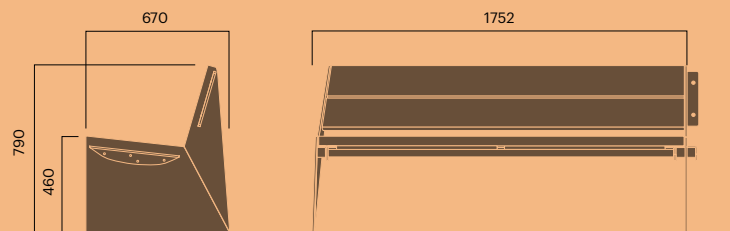

### Bloc seat

With armrests		Kg CO2	MJ
Art. 1517-900	1 590 EUR / 1 360 GBP	221	3 546
Art. 1517-901	1 280 EUR / 1 100 GBP	221	3 546

Weight: 93 kg

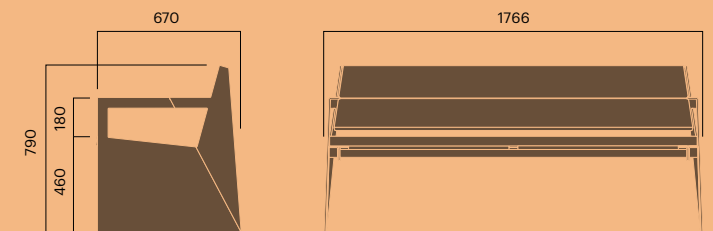

### Bloc seat add-on module

		Kg CO2	MJ
Art. 1554-900	1 240 EUR / 1 060 GBP	134	2 351
Art. 1554-901	1 080 EUR / 925 GBP	134	2 351

Weight: 66 kg

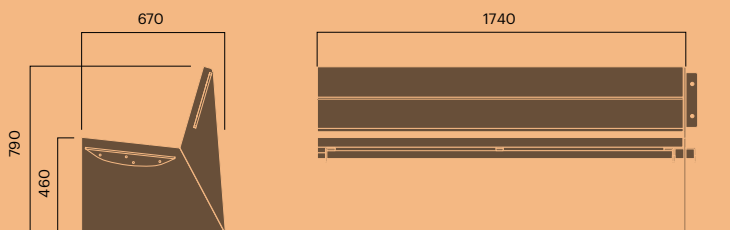

### Bloc seat start module

With armrests		Kg CO2	MJ
Art. 1556-900	1 660 EUR / 1 420 GBP	218	3 505
Art. 1556-901	1 370 EUR / 1 170 GBP	218	3 505

#### With 2 armrests for connection

Art. 1559-900	1 690 EUR / 1 450 GBP	218	3 505
Art. 1559-901	1 400 EUR / 1 200 GBP	218	3 505

Weight: 92 kg

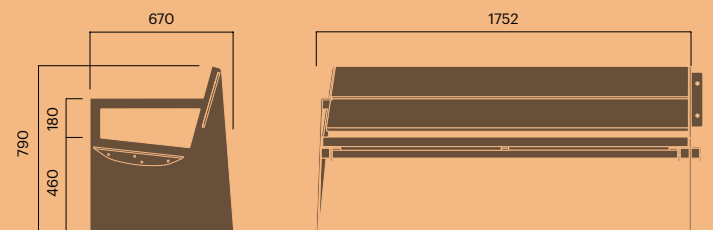

### Bloc seat end module

		Kg CO2	MJ
Art. 1555-900	1 160 EUR / 995 GBP	127	2 230
Art. 1555-901	990 EUR / 850 GBP	127	2 230

Weight: 63 kg

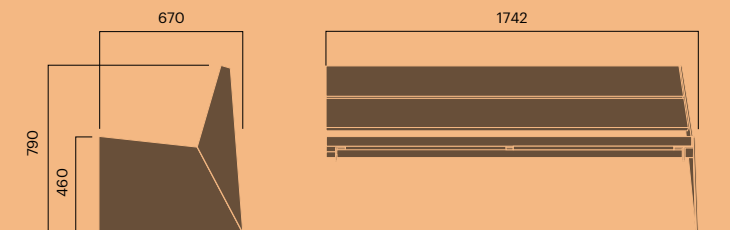

### Bloc seat add-on module

With armrests		Kg CO2	MJ
Art. 1557-900	1 250 EUR / 1 070 GBP	144	2 478
Art. 1557-901	1 130 EUR / 965 GBP	144	2 478

Weight: 70 kg

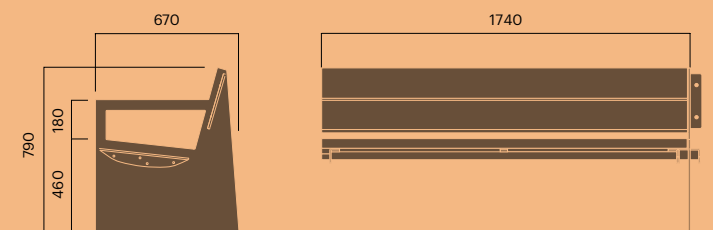

### Bloc seat end module

With armrests		Kg CO2	MJ
Art. 1558-900	1 210 EUR / 1 030 GBP	136	2 361
Art. 1558-901	1 020 EUR / 870 GBP	136	2 361

Weight: 66 kg

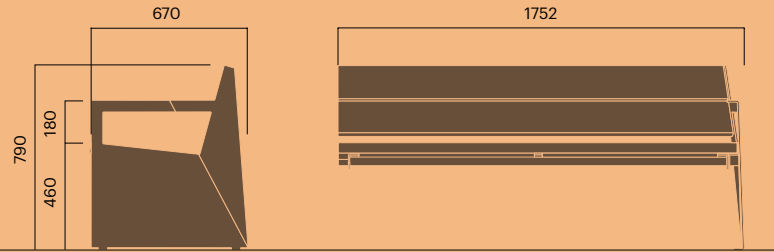

### Bloc seat double back to back

Complete seat back to back		Kg CO2	MJ
Art. 1532-900	3 470 EUR / 2 960 GBP	442	7 201
Art. 1532-901	2 840 EUR / 2 370 GBP	442	7 201

Start module back to back		Kg CO2	MJ
Art. 1574-900	3 390 EUR / 2 900 GBP	456	7 381
Art. 1574-901	2 960 EUR / 2 530 GBP	456	7 381

Weight: 200 kg

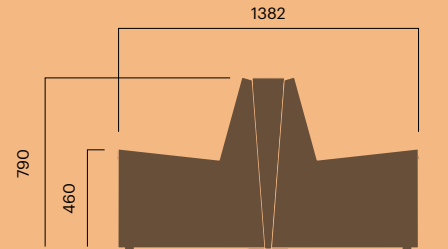

### Bloc seat double back to back with armrests

Complete seat back to back with armrests		Kg CO2	MJ
Art. 1534-900	3 540 EUR / 3 020 GBP	480	7 730
Art. 1534-901	2 980 EUR / 2 540 GBP	480	7 730

Start module back to back with armrests at the end		Kg CO2	MJ
Art. 1571-900	3 430 EUR / 2 930 GBP	476	7 655
Art. 1571-901	3 040 EUR / 2 590 GBP	476	7 655

Start module back to back with armrests for connection		Kg CO2	MJ
Art. 1570-900	3 540 EUR / 3 020 GBP	476	7 655
Art. 1570-901	3 030 EUR / 2 590 GBP	476	7 655

Weight: 210 kg

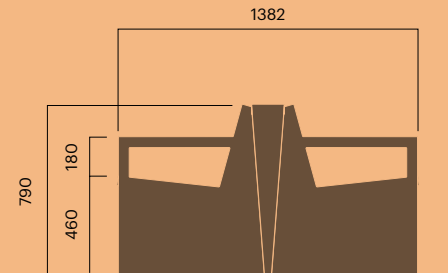

### Bloc seat back to back add-on module

Without armrests		Kg CO2	MJ
Art. 1572-900	2 250 EUR / 1 930 GBP	282	4 779
Art. 1572-901	2 160 EUR / 1 800 GBP	282	4 779

With armrests		Kg CO2	MJ
Art. 1533-900	2 330 EUR / 1 990 GBP	300	5 032
Art. 1533-901	2 120 EUR / 1 810 GBP	300	5 032

Weight: 155/165 kg



### Bloc seat back to back end module

Without armrests		Kg CO2	MJ
Art. 1575-900	2 640 EUR / 2 250 GBP	274	4 849
Art. 1575-901	2 250 EUR / 1 930 GBP	274	4 849

With armrests		Kg CO2	MJ
Art. 1573-900	2 680 EUR / 2 290 GBP	385	5 832
Art. 1573-901	2 320 EUR / 1 980 GBP	385	5 832

Weight: 155/165 kg



### Bloc low table

		Kg CO2	MJ
Art. 1530-900	1 180 EUR / 1 000 GBP	155	2 372
Art. 1530-901	1 090 EUR / 935 GBP	155	2 372

Weight: 60 kg

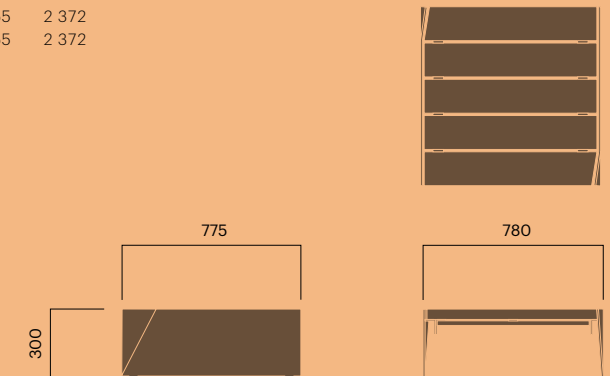



### Bloc table

		Kg CO2	MJ
Art. 1536-900	1 590 EUR / 1 360 GBP	273*	4 180*
Art. 1536-901	1 380 EUR / 1 180 GBP	273*	4 180*

#### Start module

Art. 1537-900	1 590 EUR / 1 360 GBP	273	4 180
Art. 1537-901	1 360 EUR / 1 160 GBP	273	4 180

Weight: 102/105 kg

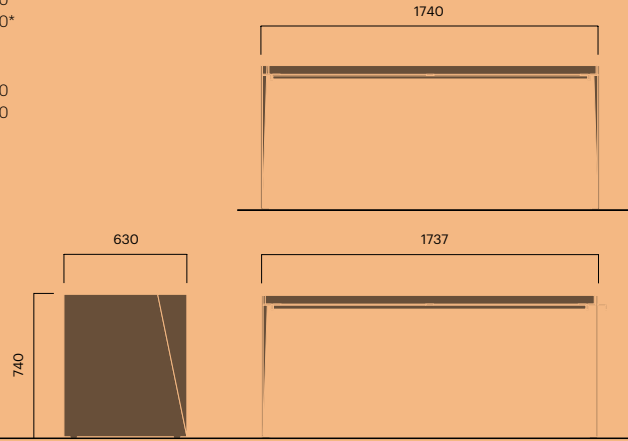

### Bloc table add-on module

		Kg CO2	MJ
Art. 1538-900	1 140 EUR / 975 GBP	166	2 697
Art. 1538-901	1 030 EUR / 880 GBP	166	2 697

#### Bloc table end module

Art. 1539-900	1 140 EUR / 975 GBP	158	2 575
Art. 1539-901	980 EUR / 840 GBP	158	2 575

Weight: 72/69 kg

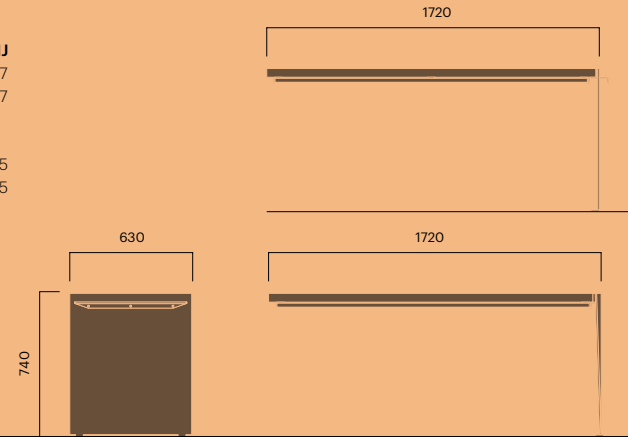

### Bloc sun bench

		Kg CO2	MJ
Art. 1566-900	2 290 EUR / 1 960 GBP	303	4 970
Art. 1566-901	1 880 EUR / 1 610 GBP	303	4 970

#### Narrow model

Art. 1565-900	2 190 EUR / 1 880 GBP	303	4 970
Art. 1565-901	1 780 EUR / 1 520 GBP	303	4 970

Weight: 134/100 kg

Optional wheels for moving 350 EUR / 300 GBP

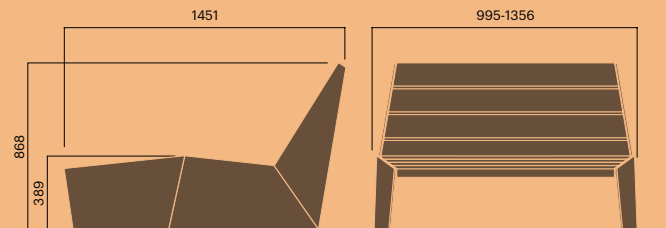

### Bloc sun bench start module

		Kg CO2	MJ
Art. 1567-900	2 420 EUR / 2 070 GBP	316	5 173
Art. 1567-901	1 970 EUR / 1 680 GBP	316	5 173

#### Short sun bench add-on module

Art. 1567-900K	2 320 EUR / 1 980 GBP	312	5 115
Art. 1567-901K	1 930 EUR / 1 650 GBP	312	5 115

Weight: 139 kg

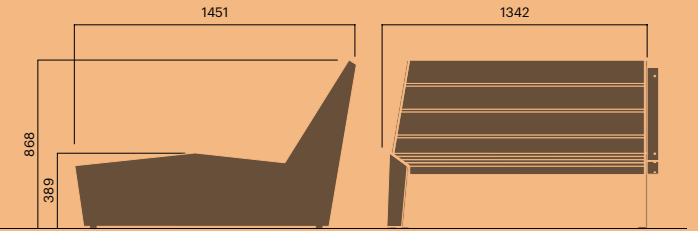

### Bloc sun bench add-on module

		Kg CO2	MJ
Art. 1568-900	1 860 EUR / 1 590 GBP	187	3 347
Art. 1568-901	1 720 EUR / 1 470 GBP	187	3 347

#### Short sun bench add-on module

Art. 1568-900K	1 810 EUR / 1 550 GBP	183	3 288
Art. 1568-901K	1 680 EUR / 1 440 GBP	183	3 288

Weight: 97 kg

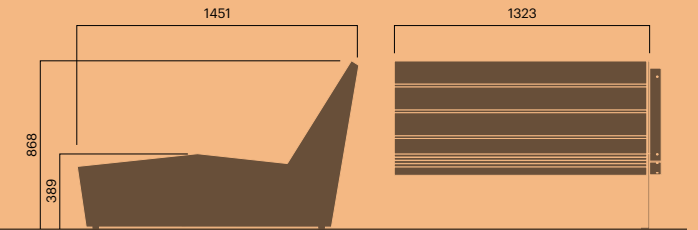

### Bloc sun bench end module

		Kg CO2	MJ
Art. 1569-900	1 660 EUR / 1 410 GBP	175	3 180
Art. 1569-901	1 420 EUR / 1 210 GBP	175	3 180

Weight: 94 kg

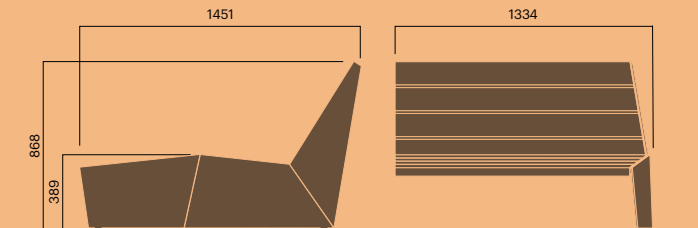

### Bloc short sun bench

		Kg CO2	MJ
Art. 1576-900	1 580 EUR / 1 350 GBP	194	3 185
Art. 1576-901	1 380 EUR / 1 180 GBP	194	3 185

Weight: 88 kg

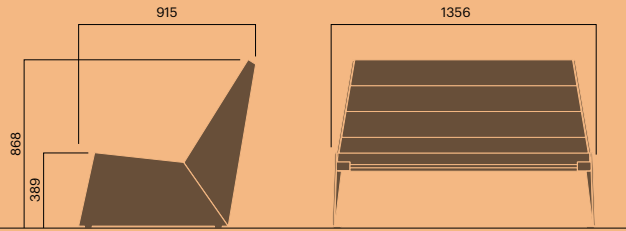

### Bloc short sun bench end module

		Kg CO2	MJ
Art. 1579-900	1 180 EUR / 1 000 GBP	109	1 862
Art. 1579-901	1 080 EUR / 925 GBP	109	1 862

Weight: 65 kg

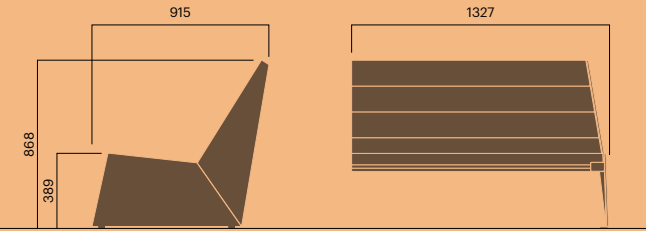

### Bloc short sun bench start module

		Kg CO2	MJ
Art. 1577-900	1 680 EUR / 1 440 GBP	239	3 816
Art. 1577-901	1 520 EUR / 1 300 GBP	239	3 816

**Connection module for long seat**

Art. 1577-900K	1 990 EUR / 1 700 GBP	274	4 367
Art. 1577-901K	1 780 EUR / 1 520 GBP	274	4 367

Weight: 130 kg

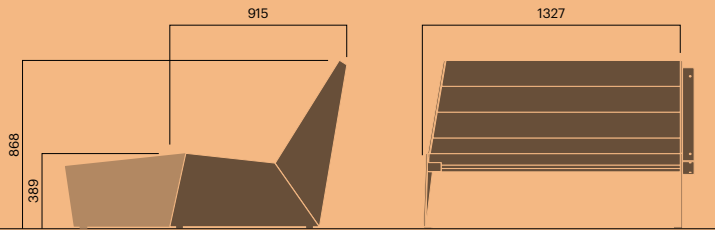

### Bloc sun bench back connection

		Kg CO2	MJ
Art. 1560-900	890 EUR / 760 GBP	67	1 009
Art. 1560-901	790 EUR / 660 GBP	67	1 009

Weight: 25 kg

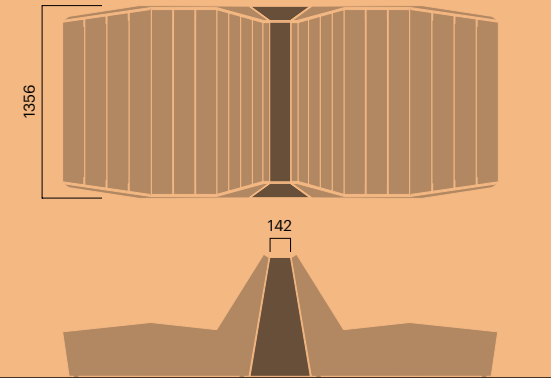

### Bloc short sun bench add-on module

		Kg CO2	MJ
Art. 1578-900	1 240 EUR / 1 050 GBP	152	2 454
Art. 1578-901	1 080 EUR / 925 GBP	152	2 454

**Connection module for long seat**

Art. 1578-900K	1 440 EUR / 1 230 GBP	181	3 005
Art. 1578-901K	1 250 EUR / 1 070 GBP	181	3 005

Weight: 65 kg

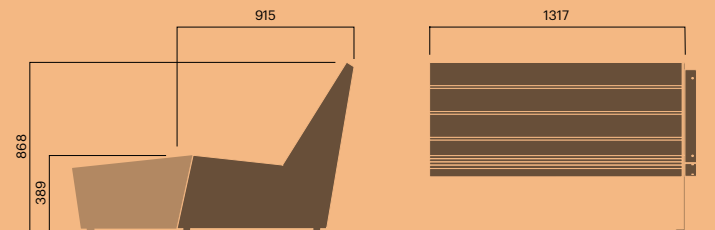

### Bloc sun bench back connection

		Kg CO2	MJ
Start module			
Art. 1561-900	890 EUR / 740 GBP	127	1 849
Art. 1561-901	790 EUR / 660 GBP	127	1 849

Weight: 20 kg

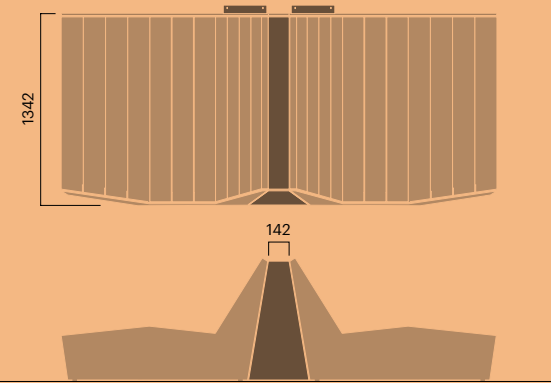

### Bloc sun bench back connection

Add-on module		Kg CO2	MJ
Art. 1562-900	580 EUR / 490 GBP	63	957
Art. 1562-901	480 EUR / 410 GBP	63	957

Weight: 20 kg

End module		Kg CO2	MJ
Art. 1563-900	580 EUR / 490 GBP	67	1 009
Art. 1563-901	480 EUR / 410 GBP	67	1 009

Weight: 20 kg

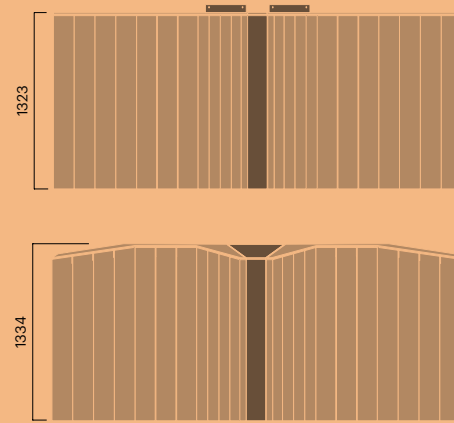

### Bloc litter bin

100 litres		Kg CO2	MJ
Art. 1542-900	1 360 EUR / 1 160 GBP	229	3 236
Art. 1542-901	1 180 EUR / 1 000 GBP	229	3 236

With ashtray		Kg CO2	MJ
Art. 1543-900	1 550 EUR / 1 320 GBP	231	3 232
Art. 1543-901	1 350 EUR / 1 160 GBP	231	3 232

Weight: 71/72 kg

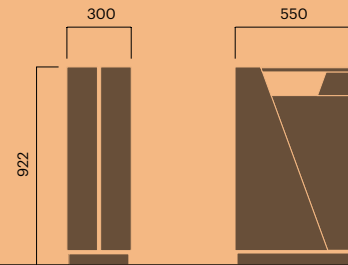

### Bloc litter bin

Wall-mounted

100 litres		Kg CO2	MJ
Art. 1546-900	1 250 EUR / 1 070 GBP	164	2 290
Art. 1546-901	1 050 EUR / 900 GBP	164	2 290

Weight: 51 kg

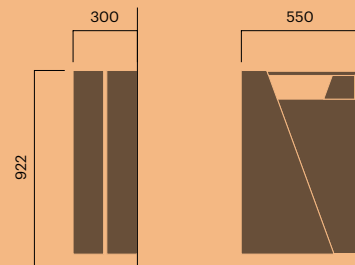

### Bloc litter bin

140 litres		Kg CO2	MJ
Art. 1544-900	1 890 EUR / 1 620 GBP	355	4 958
Art. 1544-901	1 680 EUR / 1 440 GBP	355	4 958

With ashtray		Kg CO2	MJ
Art. 1545-900	2 150 EUR / 1 840 GBP	329	4 596
Art. 1545-901	1 920 EUR / 1 640 GBP	329	4 596

Weight: 99/100 kg

### Options

Bird stopper for Bloc		Kg CO2	MJ
Art. 1540-902	290 EUR / 245 GBP	7	104

Extra allen key		Kg CO2	MJ
Art. 90007-901	12 EUR / 10 GBP		

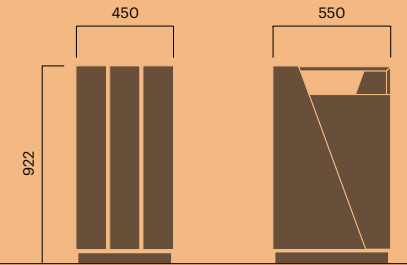

### Bloc planter

45 litres		Kg CO2	MJ
Art. 1581-900	950 EUR / 810 GBP	187	2 601
Art. 1581-901	820 EUR / 695 GBP	187	2 601

200 litres		Kg CO2	MJ
Art. 1582-900	1 740 EUR / 1 490 GBP	408	5 677
Art. 1582-901	1 480 EUR / 1 260 GBP	408	5 677

Weight: 59/130 kg

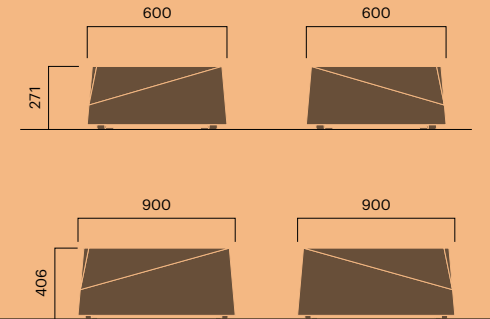

### Bloc planter

520 litres		Kg CO2	MJ
Art. 1583-900	2 740 EUR / 2 340 GBP	715	9 952
Art. 1583-901	2 320 EUR / 1 980 GBP	715	9 952

1250 litres		Kg CO2	MJ
Art. 1584-900	3 850 EUR / 3 210 GBP	1 193	16 618
Art. 1584-901	3 250 EUR / 2 780 GBP	1 193	16 618

Weight: 227/379 kg

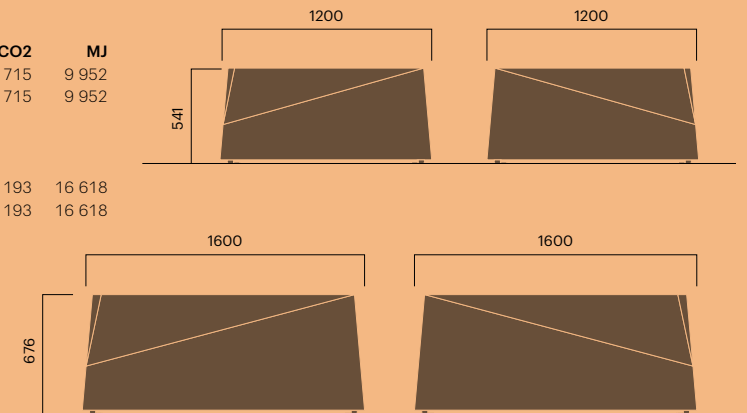

# BOBOLI

## Boboli planter

150 litres

Art. bob 065-070 **820 EUR / 700 GBP**  
Art. bob 065-070RAL **820 EUR / 700 GBP**

Weight: 35 kg

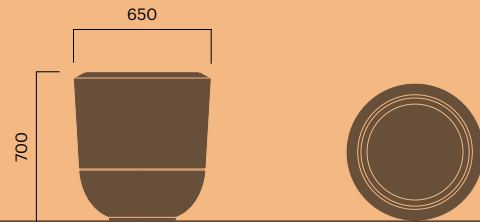

## Boboli planter

170 litres

Art. bob 090-038 **860 EUR / 730 GBP**

Weight: 35 kg



## Boboli planter

350 litres

Art. bob 130-038 **1 140 EUR / 970 GBP**

Weight: 55 kg

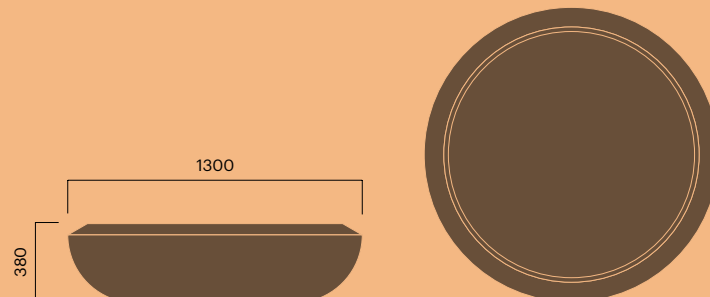

## Boboli planter

380 litres

Art. bob 090-070 **1 260 EUR / 1 080 GBP**

Weight: 65 kg

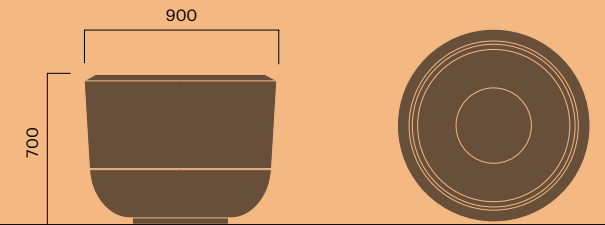

## Boboli planter

500 litres

Art. bob 090-090 **1 360 EUR / 1 160 GBP**  
Art. bob 090-090RAL **1 360 EUR / 1 160 GBP**

Weight: 80 kg

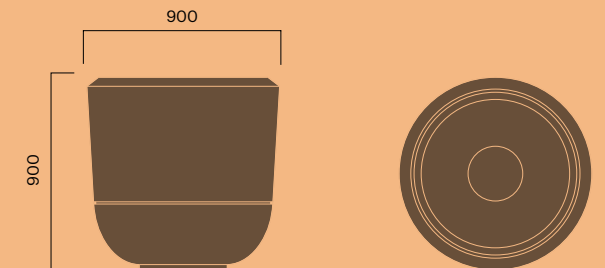

## Boboli planter

560 litres

Art. bob 120-070 **1 650 EUR / 1 410 GBP**

Weight: 80 kg

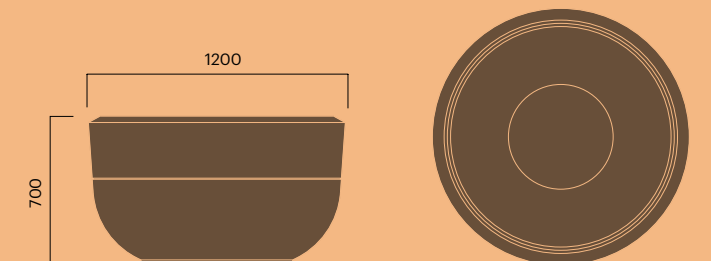

## Boboli planter

760 litres

Art. bob 180-038 **1 680 EUR / 1 440 GBP**

Weight: 70 kg

### Options for all planters

Irrigation system on request

Lifting hooks **260 EUR / 220 GBP**

Anti-graffiti treatment **170 EUR / 140 GBP**

Also available with drainage holes  
at no extra cost



## BRISKEBY

### Briskeby seat

		Kg CO2	MJ
Art. 6016-900	<b>1 590 EUR / 1 330 GBP</b>	163	2 737
Art. 6016-901	<b>1 420 EUR / 1 180 GBP</b>	163	2 737
Art. 6016-920	<b>3 480 EUR / 2 900 GBP</b>		

Weight: 73 kg

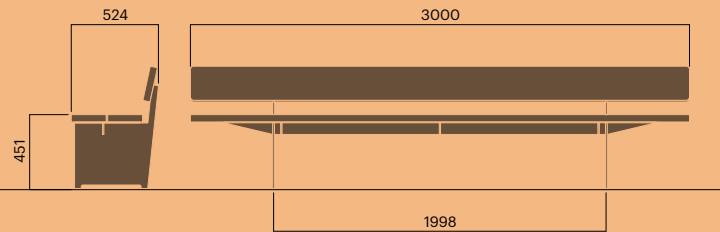

## BUZZ

### Buzz combined table and bench

Table top and seats in high pressure laminate (HPL), with optional graphic printing (at additional cost)

		Kg CO2	MJ
Art. 3316-900	<b>2 680 EUR / 2 290 GBP</b>	149	2 337
Art. 3316-901	<b>2 280 EUR / 1 950 GBP</b>	149	2 337

Table top in steel and seats in wood

Art. 3317-900	<b>2 390 EUR / 2 040 GBP</b>	244	3 489
Art. 3317-901	<b>1 850 EUR / 1 580 GBP</b>	244	3 489

Weight: 59/80 kg

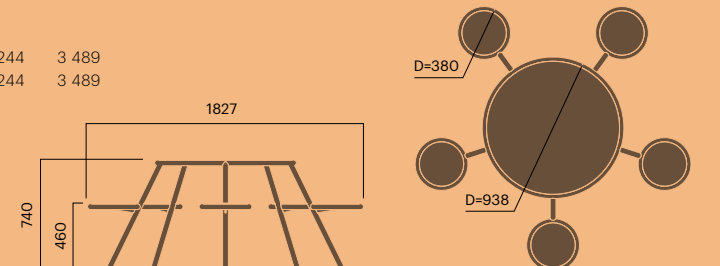

## Buzz combined table and bench adapted for wheelchair

Table top and seats in high pressure laminate (HPL), with optional graphic printing (at additional cost)

		Kg CO2	MJ
Art. 3316-900HC	<b>2 390 EUR / 1 990 GBP</b>	144	2 247
Art. 3316-901HC	<b>1 980 EUR / 1 650 GBP</b>	144	2 247

Table top in steel and seats in wood

Art. 3317-900HC	<b>2 250 EUR / 1 930 GBP</b>	223	3 171
Art. 3317-901HC	<b>1 690 EUR / 1 440 GBP</b>	223	3 171

Weight: 50/70 kg

Should be bolted to the ground

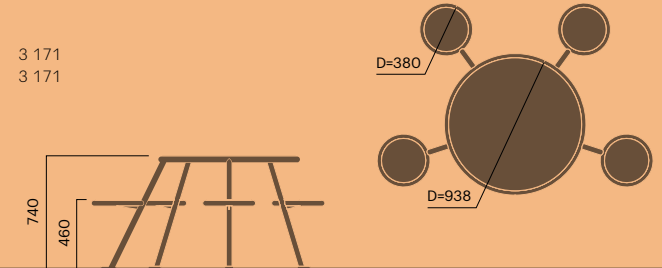

## BØY

### Bøy cycle rack

For 2 bicycles

		Kg CO2	MJ
Art. 388-900	<b>290 EUR / 245 GBP</b>	37	512
Art. 388-901	<b>230 EUR / 195 GBP</b>	37	512

Weight: 12 kg

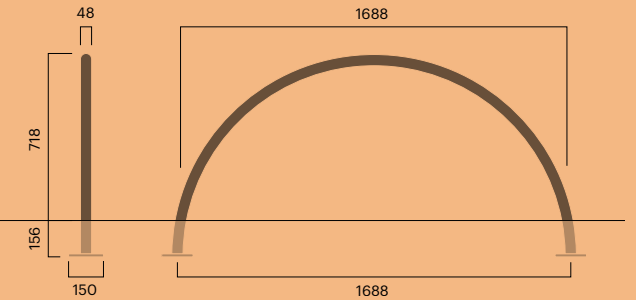

## CITY

### City litter bin

For mounting on a pole or wall

50 litres

		Kg CO2	MJ
Art. 241-900	<b>680 EUR / 585 GBP</b>	91	1 274
Art. 241-901	<b>530 EUR / 450 GBP</b>	91	1 274

With domed top

Art. 251-900	<b>750 EUR / 645 GBP</b>	101	1 409
Art. 251-901	<b>640 EUR / 545 GBP</b>	101	1 409

With ashtray

Art. 259-900	<b>960 EUR / 820 GBP</b>	102	1 428
Art. 259-901	<b>850 EUR / 730 GBP</b>	102	1 428

Weight: 31 kg

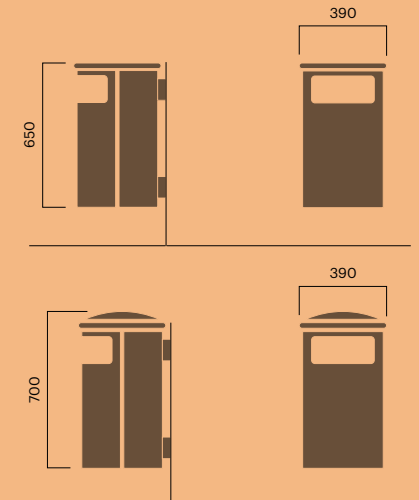

## City litter bin split opening

50 litres

With flat top		Kg CO2	MJ
Art. 244-900	690 EUR / 595 GBP	98	1 366
Art. 244-901	540 EUR / 450 GBP	98	1 366

With domed top		Kg CO2	MJ
Art. 254-900	760 EUR / 645 GBP	99	1 387
Art. 254-901	650 EUR / 540 GBP	99	1 387

With ashtray		Kg CO2	MJ
Art. 255-900	990 EUR / 850 GBP	98	1 366
Art. 255-901	790 EUR / 660 GBP	98	1 366

Weight: 31 kg



## City fastening clamps

Set

For 4" pole D 101		Kg CO2	MJ
Art. 290-900	110 EUR / 90 GBP	7	94
Art. 290-901	80 EUR / 65 GBP	7	94

For 5" pole D 127		Kg CO2	MJ
Art. 291-900	110 EUR / 90 GBP	7	99
Art. 291-901	80 EUR / 65 GBP	7	99

Weight: 3 kg



## City mounting pole

Anchoring A or C		Kg CO2	MJ
Art. 292-900A	160 EUR / 135 GBP	25	352
Art. 292-901A	150 EUR / 135 GBP	25	352
Art. 292-900C	130 EUR / 115 GBP	29	399
Art. 292-901C	120 EUR / 105 GBP	29	399

Pole D=76/60		Kg CO2	MJ
Art. 293-900C	160 EUR / 135 GBP	25	344
Art. 293-901C	150 EUR / 130 GBP	25	344

Concrete foundation		Kg CO2	MJ
Art. 193-004	40 EUR / 35 GBP	6	212

Weight: 8/8/29 kg

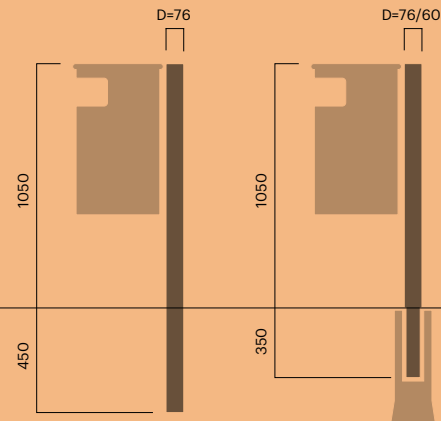

## City litter bin

70 litres

With flat top		Kg CO2	MJ
Art. 242-900	870 EUR / 750 GBP	106	1 474
Art. 242-901	720 EUR / 615 GBP	106	1 474

With domed top		Kg CO2	MJ
Art. 252-900	920 EUR / 790 GBP	115	1 605
Art. 252-901	850 EUR / 730 GBP	115	1 605

With ashtray		Kg CO2	MJ
Art. 243-900	1 180 EUR / 1 000 GBP	119	1 658
Art. 243-901	1 030 EUR / 880 GBP	119	1 658

Weight: 36/38 kg

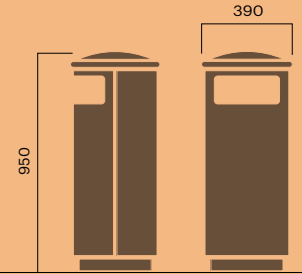

## City concrete foundation

For City litter bins (70 L) and ashtray (17 L and 60 L)		Kg CO2	MJ
Art. 267-004	80 EUR / 65 GBP	6	220

Weight: 28 kg

## Options

Bird stopper for City 50/70 L		Kg CO2	MJ
Art. 201-902	110 EUR / 90 GBP	11	200

Bird stopper for City 150/180 L		Kg CO2	MJ
Art. 202-902	200 EUR / 170 GBP	18	333

Extra allen key		Kg CO2	MJ
Art. 90007-901	12 EUR / 10 GBP		

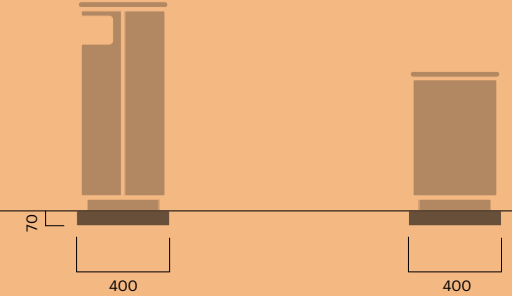

## City litter bin

150 litres

With flat top		Kg CO2	MJ
Art. 247-900	920 EUR / 790 GBP	139	1 931
Art. 247-901	710 EUR / 605 GBP	139	1 931

With domed top		Kg CO2	MJ
Art. 257-900	1 030 EUR / 880 GBP	132	1 920
Art. 257-901	820 EUR / 695 GBP	132	1 920

With ashtray		Kg CO2	MJ
Art. 261-900	1 190 EUR / 1 010 GBP	132	1 920
Art. 261-901	1 090 EUR / 935 GBP	132	1 920

Weight: 43/49/49 kg

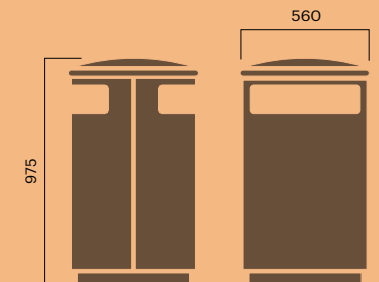

## City litter bin split opening

150 litres

With domed top		Kg CO2	MJ
Art. 277-900	1 050 EUR / 900 GBP	159	2 214
Art. 277-901	860 EUR / 740 GBP	159	2 214

With ashtray		Kg CO2	MJ
Art. 278-900	1 250 EUR / 1 070 GBP	164	2 290
Art. 278-901	1 140 EUR / 975 GBP	164	2 290

With recycling for empty bottles		Kg CO2	MJ
Art. 279-900	1 480 EUR / 1 260 GBP	178	2 477
Art. 279-901	1 280 EUR / 1 100 GBP	178	2 477

With ashtray and recycling for empty bottles		Kg CO2	MJ
Art. 280-900	1 680 EUR / 1 440 GBP	183	2 552
Art. 280-901	1 570 EUR / 1 340 GBP	183	2 552

Weight: 53 kg

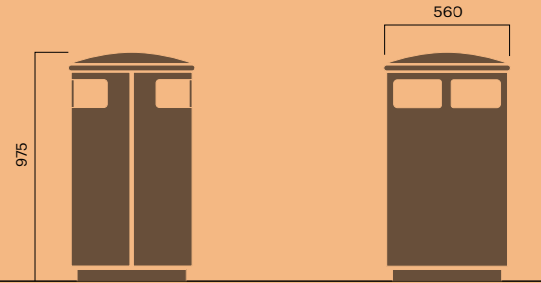

## City litter bin

180 litres

With flat top		Kg CO2	MJ
Art. 248-900	960 EUR / 820 GBP	157	2 184
Art. 248-901	710 EUR / 605 GBP	157	2 184

With domed top		Kg CO2	MJ
Art. 258-900	1 040 EUR / 890 GBP	176	2 453
Art. 258-901	830 EUR / 705 GBP	176	2 453

With ashtray		Kg CO2	MJ
Art. 262-900	1 230 EUR / 1 050 GBP	181	2 520
Art. 262-901	1 110 EUR / 955 GBP	181	2 520

Weight: 47/53/53 kg

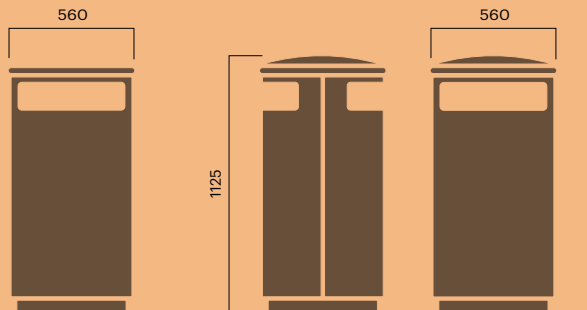

## City litter bin split opening

180 litres

With flat top		Kg CO2	MJ
Art. 276-900	970 EUR / 830 GBP	177	2 472
Art. 276-901	720 EUR / 615 GBP	177	2 472

With domed top		Kg CO2	MJ
Art. 275-900	1 090 EUR / 935 GBP	177	2 472
Art. 275-901	890 EUR / 760 GBP	177	2 472

With ashtray		Kg CO2	MJ
Art. 274-900	1 360 EUR / 1 160 GBP	182	2 535
Art. 274-901	1 160 EUR / 995 GBP	182	2 535

Weight: 57 kg

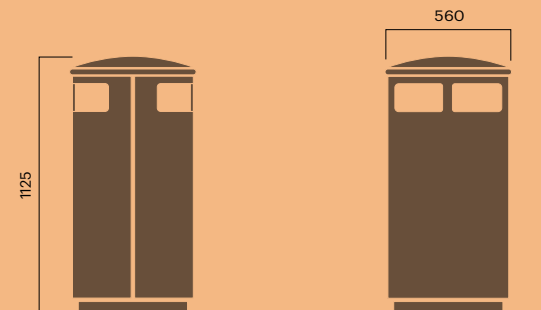

## City recycling for empty bottles

180 litres

With flat top		Kg CO2	MJ
Art. 270-900	1 490 EUR / 1 240 GBP	194	2 704
Art. 270-901	1 320 EUR / 1 100 GBP	194	2 704

With domed top		Kg CO2	MJ
Art. 272-900	1 620 EUR / 1 350 GBP	194	2 704
Art. 272-901	1 380 EUR / 1 150 GBP	194	2 704

With ashtray		Kg CO2	MJ
Art. 271-900	1 780 EUR / 1 480 GBP	194	2 704
Art. 271-901	1 650 EUR / 1 380 GBP	194	2 704

Weight: 57/63/63 kg

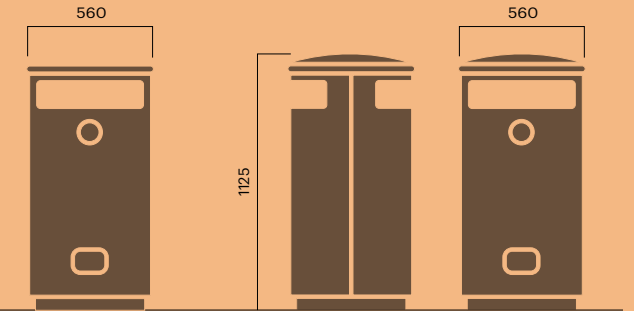

## City concrete foundation

For City litter bins (150 L and 180 L) and large ashtray

	Kg CO2	MJ
Art. 247-004	95 EUR / 80 GBP	14 496

Weight: 58 kg

## Options

Bird stopper for City 50/70L		Kg CO2	MJ
Art. 201-902	110 EUR / 90 GBP	11	200

Bird stopper for City 150/180 L		Kg CO2	MJ
Art. 202-902	200 EUR / 170 GBP	18	333

Extra allen key		Kg CO2	MJ
Art. 90007-901	12 EUR / 10 GBP		

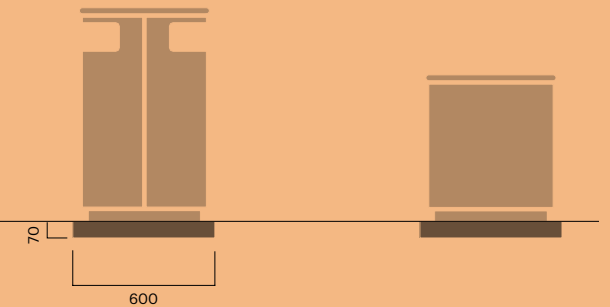

## City ashtray

Wall-mounted		Kg CO2	MJ
Art. 265-900	320 EUR / 275 GBP	18	253
Art. 265-901	300 EUR / 255 GBP	18	253

For mounting pole		Kg CO2	MJ
Art. 266-900	330 EUR / 285 GBP	20	286
Art. 266-901	320 EUR / 275 GBP	20	286

Weight: 5 kg

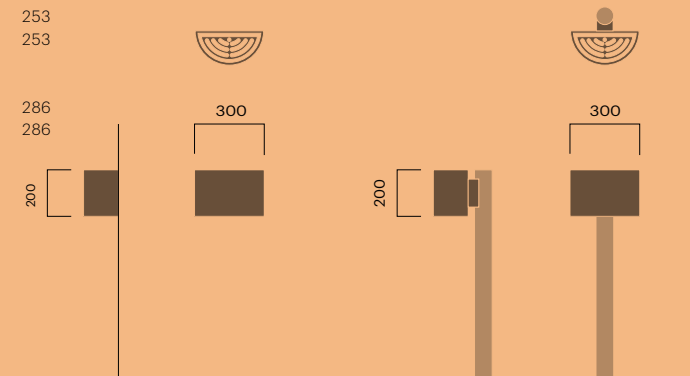

## City ashtray

### With flat top (60 L)

Art.	Price	Kg CO2	MJ
Art. 267-900	850 EUR / 730 GBP	82	1 190
Art. 267-901	770 EUR / 655 GBP	82	1 190

### With flat top (120 L)

Art.	Price	Kg CO2	MJ
Art. 268-900	970 EUR / 830 GBP	109	1 601
Art. 268-901	890 EUR / 760 GBP	109	1 601

Weight: 28/40 kg

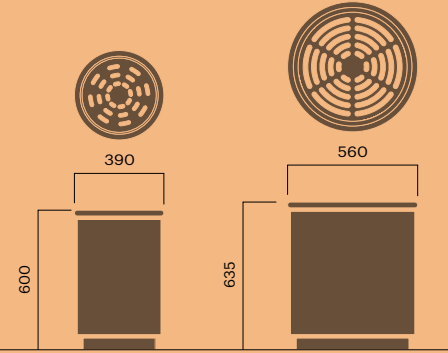

## City ashtray

### With domed top and receptable (17 L)

H:	Price	Kg CO2	MJ
630	Art. 263-900: 770 EUR / 655 GBP Art. 263-901: 700 EUR / 595 GBP	121	1 346

H:	Price	Kg CO2	MJ
930	Art. 264-900: 840 EUR / 720 GBP Art. 264-901: 760 EUR / 645 GBP	152	1 766

Weight: 37/45 kg

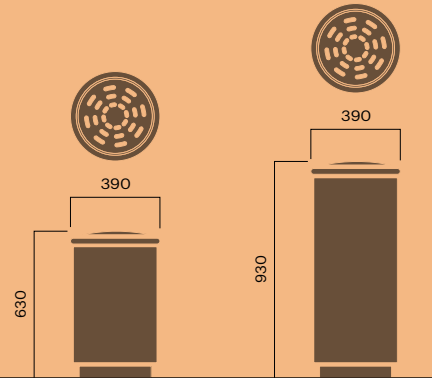

## City bicycle post

### Complete with foundation

For	Price	Kg CO2	MJ
2 bicycles	Art. 286-800: 420 EUR / 360 GBP	82	1 270

Weight: 20 kg

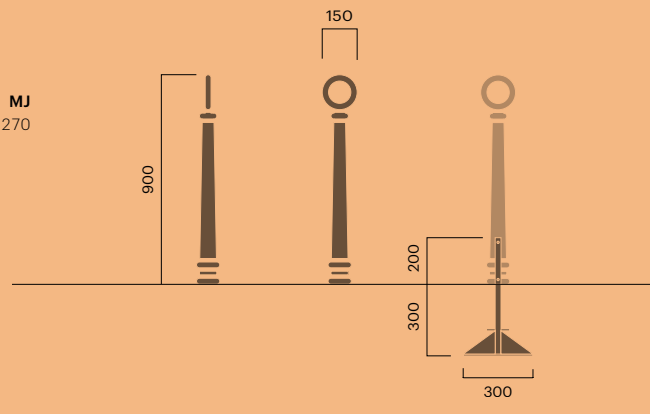

## COAST

### Coast bench made from ownerless ocean plastic

Art.	Price	Kg CO2	MJ
Art. 5506-530			
Art. 5506-531			

Rental model available on request

### Option with wood slats

Art.	Price	Kg CO2	MJ
Art. 5506-900	1 980 EUR / 1 650 GBP	170	2 616
Art. 5506-901	1 750 EUR / 1 460 GBP	170	2 616

Weight: 66 kg

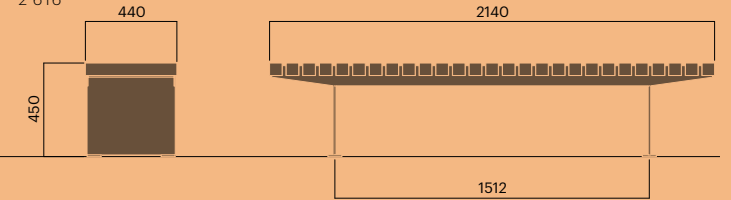

## CODE

### Code Square module bench

Art.	Price	Kg CO2	MJ
Art. 2616-900	1 220 EUR / 1 050 GBP	137	2 226
Art. 2616-901	1 070 EUR / 910 GBP	137	2 226

### Base module, without wood

Art.	Price	Kg CO2	MJ
Art. 2617-900	620 EUR / 535 GBP	100	1 393
Art. 2617-901	500 EUR / 430 GBP	100	1 393

### Wooden seat

Art.	Price	Kg CO2	MJ
Art. 2620-900	460 EUR / 390 GBP	20	494
Art. 2620-901	440 EUR / 380 GBP	20	494

### Wooden front

Art.	Price	Kg CO2	MJ
Art. 2624-900	310 EUR / 270 GBP	17	349
Art. 2624-901	290 EUR / 245 GBP	17	349

### Armrest

Art.	Price	Kg CO2	MJ
Art. 2628-900	430 EUR / 370 GBP	42	586
Art. 2628-901	390 EUR / 335 GBP	42	586

Weight: 59/31/17/55 kg

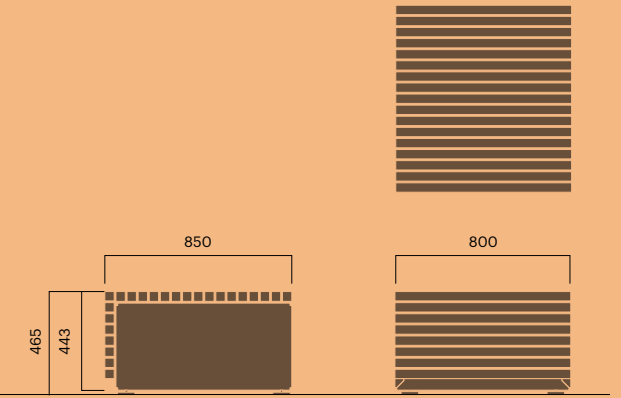

### Code Square planter

#### 250 litres

Art.	Price	Kg CO2	MJ
Art. 2640-900	1 150 EUR / 985 GBP	182	2 530
Art. 2640-901	990 EUR / 850 GBP	182	2 530

#### 500 litres

Art.	Price	Kg CO2	MJ
Art. 2646-900	1 480 EUR / 1 260 GBP	285	3 975
Art. 2646-901	1 290 EUR / 1 110 GBP	285	3 975

Weight: 30/60 kg

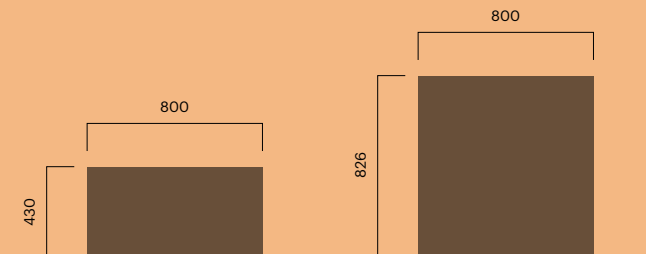



# COVER

## Cover roof

With steel plate		Kg CO2	MJ
Art. 4701-900A	9 800 EUR / 8 170 GBP	1 945	27 166
Art. 4701-901A	8 500 EUR / 7 080 GBP	1 945	27 166

With glass		Kg CO2	MJ
Art. 4702-900A	9 800 EUR / 8 375 GBP	1 446	21 065
Art. 4702-901A	9 200 EUR / 7 860 GBP	1 446	21 065

With sedum		Kg CO2	MJ
Art. 4703-900A	9 800 EUR / 8 375 GBP	1 880	29 114
Art. 4703-901A	9 200 EUR / 7 860 GBP	1 880	29 114

Weight: 660 kg

Optional LED lighting, wifi, solar panels and charging

Price on request

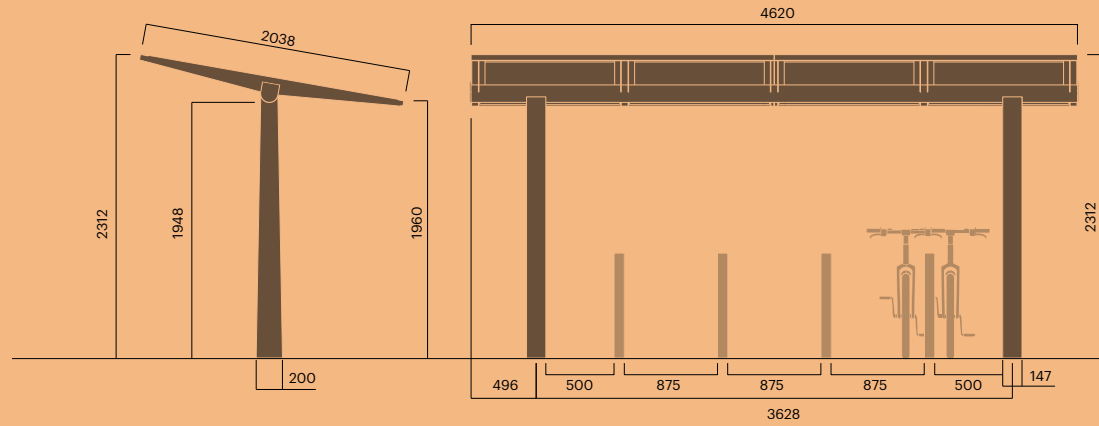

# CORNER

## Corner for wall top

		Kg CO2	MJ
Art. 4103-900MK	1 190 EUR / 1 010 GBP	79	1 384
Art. 4103-901MK	1 090 EUR / 935 GBP	79	1 384

Weight: 37 kg

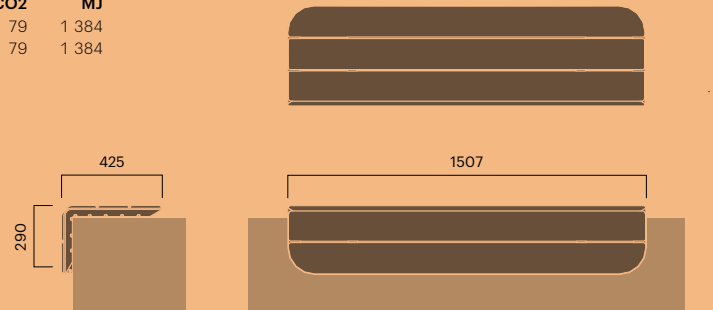

## Corner single seat for wall top

		Kg CO2	MJ
Art. 4104-900MK	980 EUR / 840 GBP	37	585
Art. 4104-901MK	890 EUR / 760 GBP	37	585

Weight: 14 kg

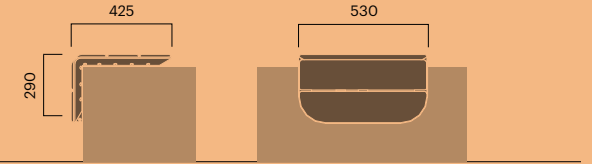

# CYCLE

## Cycle bicycle rack for 2 bicycles

Anchoring with base plate		Kg CO2	MJ
Art. 4886-900A	480 EUR / 400 GBP	52	718
Art. 4886-901A	440 EUR / 370 GBP	52	718

Concreting in place		Kg CO2	MJ
Art. 4886-900C	460 EUR / 380 GBP	47	657
Art. 4886-901C	420 EUR / 350 GBP	47	657

Weight: 16 kg

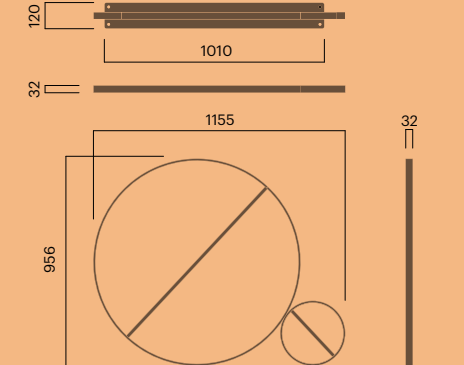

# DIALOG

## Dialog bench

Kebony Clear		Kg CO2	MJ
Art. 1406-932	2 980 EUR / 2 550 GBP	29	884

Oak		Kg CO2	MJ
Art. 1406-942	2 980 EUR / 2 550 GBP	21	1 115

Weight: 31 kg

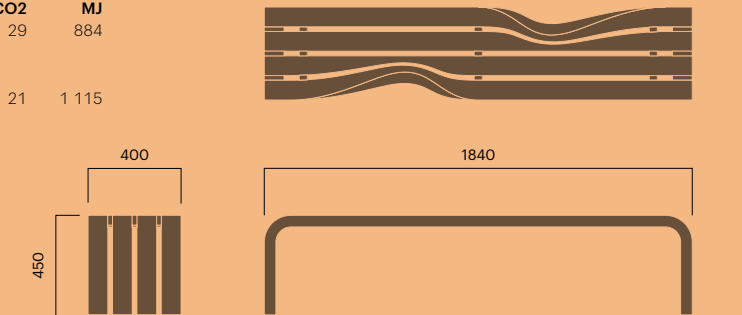

## Dialog litter bin

100 litres

		Kg CO2	MJ
Art. 1442-900	1 380 EUR / 1 180 GBP	178	2 444
Art. 1442-901	1 220 EUR / 1 050 GBP	178	2 444

Weight: 84 kg

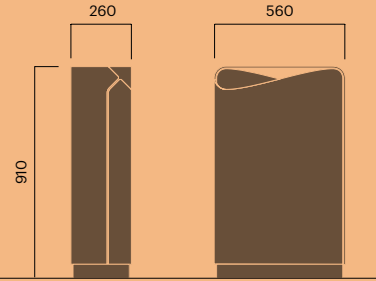

## Dialog recycling

3 x 55 litres

		Kg CO2	MJ
Art. 1448-900	2 250 EUR / 1 930 GBP	282	3 932
Art. 1448-901	2 050 EUR / 1 710 GBP	282	3 932

3 x 90 litres

Art. 1444-900	2 450 EUR / 2 090 GBP
Art. 1444-901	2 250 EUR / 1 930 GBP

Weight: 90/100 kg

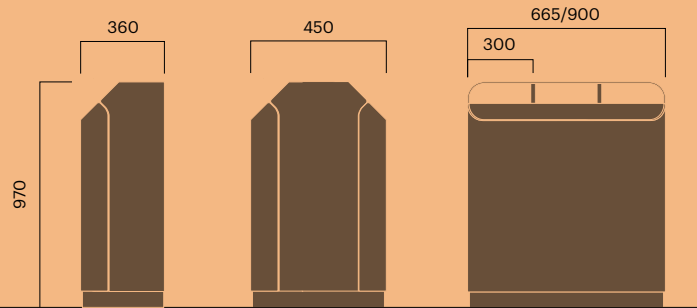

## EDO

### Edo bench with marble table

		Kg CO2	MJ
Art. 4308-930	2 480 EUR / 2 120 GBP	55	1 383
Art. 4308-940	2 480 EUR / 2 120 GBP	18	1 076
Art. 4308-950	2 480 EUR / 2 120 GBP	18	1 076

Weight: 30 kg

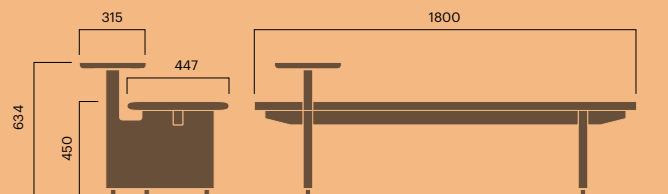

## Edo seat

Kebony, oak and ash

		Kg CO2	MJ
Art. 4316-930	2 980 EUR / 2 550 GBP	57	1 427
Art. 4316-940	2 980 EUR / 2 550 GBP	14	1 079
Art. 4316-950	2 980 EUR / 2 550 GBP	14	1 079

Weight: 40 kg

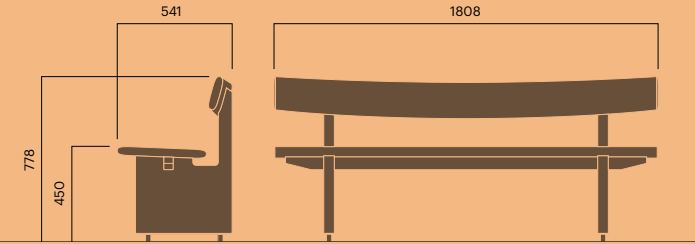

### Edo seat with steel frame

		Kg CO2	MJ
Art. 4315-900	1 940 EUR / 1 660 GBP	120	2 266
Art. 4315-901	1 820 EUR / 1 550 GBP	120	2 266

Weight: 50 kg

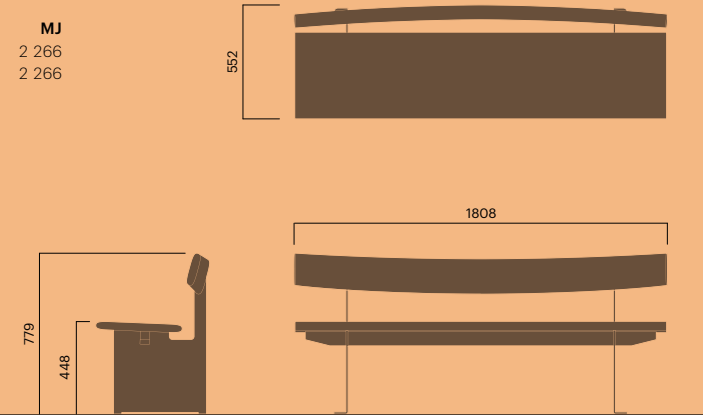

## FOLK

### Folk bench with armrests

		Kg CO2	MJ
Art. 4904-904A	1 080 EUR / 925 GBP	61	1 168

Concreting in place

Art. 4904-904C	950 EUR / 810 GBP	50	983
----------------	-------------------	----	-----

Free-standing

Art. 4904-904	1 180 EUR / 1 000 GBP	41	839
---------------	-----------------------	----	-----

Weight: 22 kg

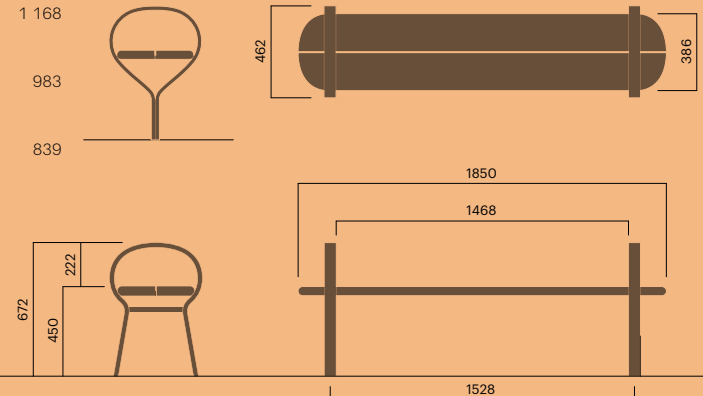

## Folk seat with armrests

Installation	Art. No.	Price (EUR / GBP)	Kg CO2	MJ
Anchoring with base plate	Art. 4914-904A	1 390 EUR / 1 160 GBP	77	1 521
Concreting in place	Art. 4914-904C	1 150 EUR / 985 GBP	67	1 347
Free-standing	Art. 4914-904	1 290 EUR / 1 110 GBP	52	1 095

Weight: 29 kg

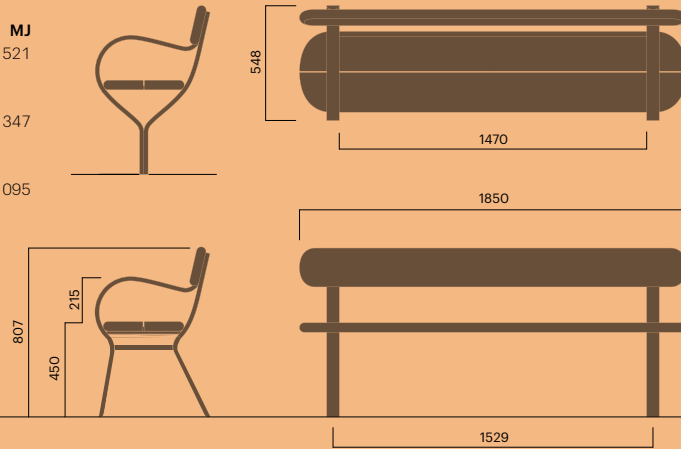

## Folk table

Installation	Art. No.	Price (EUR / GBP)	Kg CO2	MJ
Anchoring with base plate	Art. 4933-904A	1 290 EUR / 1 110 GBP	108	2 104
Concreting in place	Art. 4933-904C	1 120 EUR / 930 GBP	96	1 908
Free-standing	Art. 4933-904	1 290 EUR / 1 110 GBP	54	1 201

Weight: 38 kg

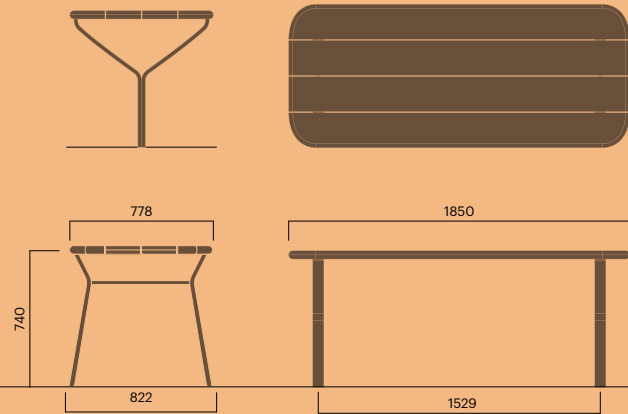

## Folk litter bin

50 litres

Installation	Art. No.	Price (EUR / GBP)	Kg CO2	MJ
Flat top, anchoring with base plate	Art. 4942-904A	1 280 EUR / 1 070 GBP	134	1 944
Flat top, concreting in place	Art. 4942-904C	1 180 EUR / 980 GBP	134	1 944
Oblique top, anchoring with base plate	Art. 4943-904A	1 280 EUR / 1 070 GBP	106	1 568
Oblique top, concreting in place	Art. 4943-904C	1 180 EUR / 1 000 GBP	106	1 568

Weight: 28/27 kg

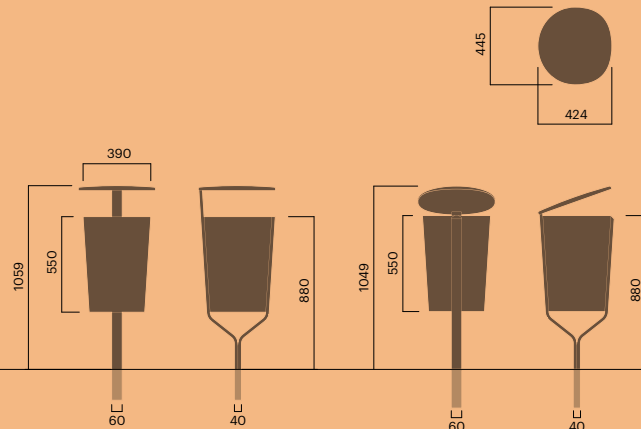

## Folk litter bin

140 litres

Installation	Art. No.	Price (EUR / GBP)	Kg CO2	MJ
Anchoring with base plate	Art. 4944-904A	1 590 EUR / 1 360 GBP	212	3 039

Weight: 40 kg

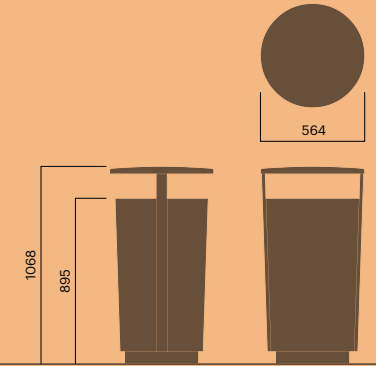

## Folk bicycle rack

Installation	Art. No.	Price (EUR / GBP)	Kg CO2	MJ
Large, anchoring with base plate	Art. 4986-904A	350 EUR / 295 GBP	28	464
Large, concreting in place	Art. 4986-904C	270 EUR / 235 GBP	22	371
Small, anchoring with base plate	Art. 4987-904A	340 EUR / 285 GBP	28	469
Small, concreting in place	Art. 4987-904C	260 EUR / 225 GBP	22	371

Weight: 7 kg

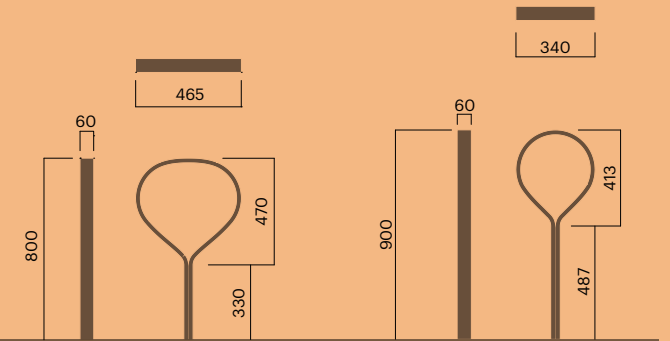

## FORUM

### Forum bench

1 metre

Installation	Art. No.	Price (EUR / GBP)	Kg CO2	MJ
Free-standing	Art. 2502-900	1 220 EUR / 1 050 GBP	150	2 249
Free-standing	Art. 2502-901	1 120 EUR / 955 GBP	150	2 249
Anchoring A or C	Art. 2502-900A	1 020 EUR / 870 GBP	120	1 831
Anchoring A or C	Art. 2502-901A	890 EUR / 760 GBP	120	1 831
Anchoring A or C	Art. 2502-900C	980 EUR / 840 GBP	132	1 996
Anchoring A or C	Art. 2502-901C	850 EUR / 730 GBP	132	1 996

Weight: 56/46/50 kg

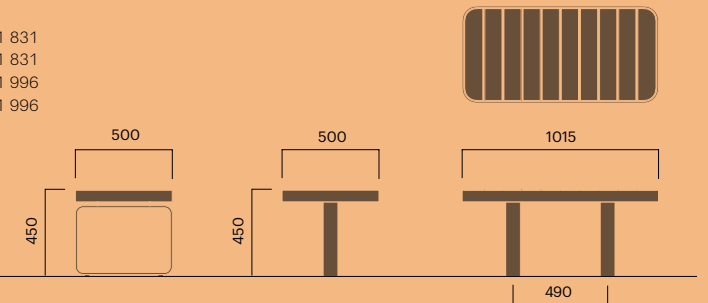

## Forum bench

2 metres

Free-standing		Kg CO2	MJ
Art. 2503-900	1 820 EUR / 1 560 GBP	196	3 056
Art. 2503-901	1 580 EUR / 1 350 GBP	196	3 056

### Anchoring A or C

Art. 2503-900A	1 520 EUR / 1 300 GBP	196	3 056
Art. 2503-901A	1 340 EUR / 1 150 GBP	196	3 056
Art. 2503-900C	1 480 EUR / 1 260 GBP	177	2 793
Art. 2503-901C	1 290 EUR / 1 110 GBP	177	2 793

Weight: 77/68/71 kg

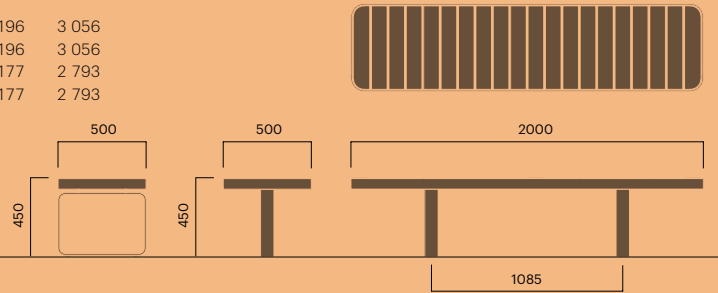

## Forum bench

3 metres

Free-standing		Kg CO2	MJ
Art. 2504-900	2 250 EUR / 1 930 GBP	246	3 929
Art. 2504-901	1 980 EUR / 1 690 GBP	246	3 929

### Anchoring A or C

Art. 2504-900A	1 990 EUR / 1 700 GBP	215	3 497
Art. 2504-901A	1 650 EUR / 1 410 GBP	215	3 497
Art. 2504-900C	1 950 EUR / 1 670 GBP	227	3 666
Art. 2504-901C	1 610 EUR / 1 370 GBP	227	3 666

Weight: 101/92/93 kg

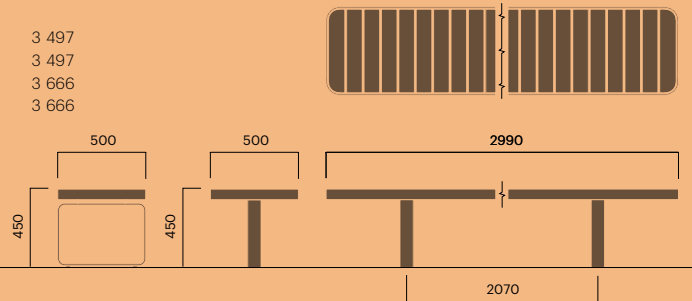

## Forum armrest and back

Armrest		Kg CO2	MJ
Art. 2525-900	160 EUR / 135 GBP	10	133
Art. 2525-901	130 EUR / 115 GBP	10	133

Weight: 6 kg

### Backrest for 2 and 3 metre bench

Art. 2522-900	560 EUR / 480 GBP	31	498
Art. 2522-901	440 EUR / 380 GBP	31	498

Weight: 10 kg

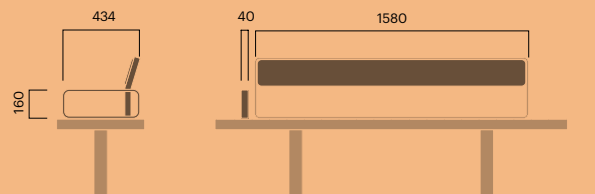

## Forum table

1 metre

Free-standing		Kg CO2	MJ
Art. 2532-900	1 280 EUR / 1 100 GBP	173	2 571
Art. 2532-901	1 180 EUR / 1 000 GBP	173	2 571

### Anchoring A or C

Art. 2532-900A	1 050 EUR / 900 GBP	135	2 041
Art. 2532-901A	920 EUR / 790 GBP	135	2 041
Art. 2532-900C	990 EUR / 850 GBP	146	2 200
Art. 2532-901C	860 EUR / 740 GBP	146	2 200

Weight: 63/51/55 kg

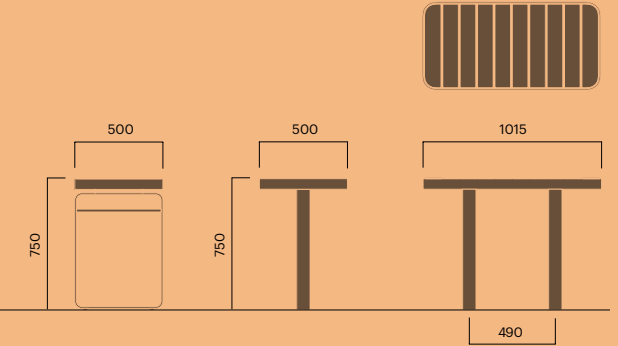

## Forum table

2 metres

Free-standing		Kg CO2	MJ
Art. 2533-900	1 980 EUR / 1 690 GBP	221	3 413
Art. 2533-901	1 780 EUR / 1 520 GBP	221	3 413

### Anchoring A or C

Art. 2533-900A	1 680 EUR / 1 440 GBP	180	2 841
Art. 2533-901A	1 390 EUR / 1 190 GBP	180	2 841
Art. 2533-900C	1 620 EUR / 1 380 GBP	204	3 174
Art. 2533-901C	1 360 EUR / 1 160 GBP	204	3 174

Weight: 87/61/73 kg

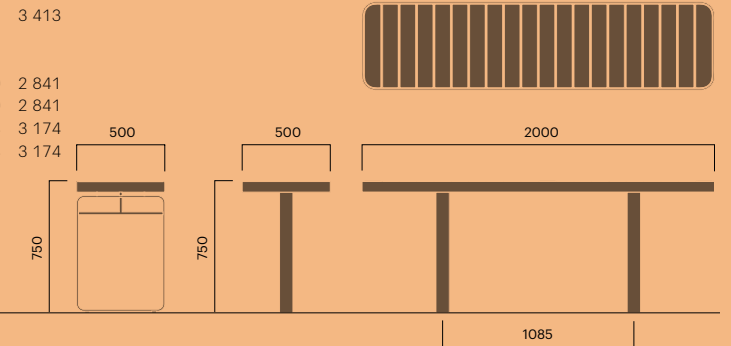

## Forum table

3 metres

### Free-standing

W500		Kg CO2	MJ
Art. 2534-900	2 440 EUR / 2 080 GBP	267	4 213
Art. 2534-901	2 080 EUR / 1 770 GBP	267	4 213

### W750

Art. 2536-900	2 980 EUR / 2 540 GBP	387	6 135
Art. 2536-901	2 450 EUR / 2 090 GBP	387	6 135

Weight: 110/165 kg

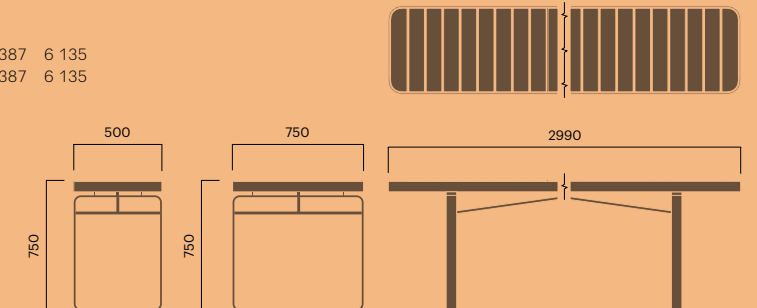

## Forum table

3 metres

Anchoring A or C

W500		Kg CO2	MJ
Art. 2534-900A	2 020 EUR / 1 720 GBP	230	3 708
Art. 2534-901A	1 780 EUR / 1 520 GBP	230	3 708
Art. 2534-900C	1 960 EUR / 1 670 GBP	242	3 868
Art. 2534-901C	1 720 EUR / 1 470 GBP	242	3 868

W750		Kg CO2	MJ
Art. 2536-900A	2 590 EUR / 2 210 GBP	272	4 531
Art. 2536-901A	2 360 EUR / 2 020 GBP	272	4 531
Art. 2536-900C	2 530 EUR / 2 160 GBP	269	4 493
Art. 2536-901C	2 280 EUR / 1 950 GBP	269	4 493

Weight: 96/145 kg

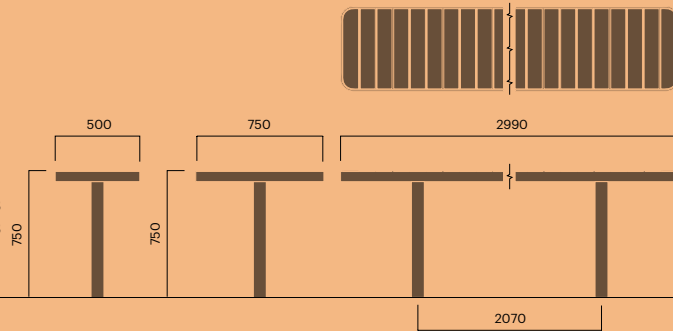

## Forum litter bin

130 litres

		Kg CO2	MJ
Art. 2542-900	1 690 EUR / 1 450 GBP	180	2 475
Art. 2542-901	1 420 EUR / 1 210 GBP	180	2 475
Art. 2543-900	1 690 EUR / 1 450 GBP	183	2 521
Art. 2543-901	1 420 EUR / 1 210 GBP	183	2 521
Art. 2544-900	1 690 EUR / 1 450 GBP	355	4 958
Art. 2544-901	1 420 EUR / 1 180 GBP	355	4 958
Art. 2545-900	1 690 EUR / 1 450 GBP	175	2 404
Art. 2545-901	1 420 EUR / 1 210 GBP	175	2 404

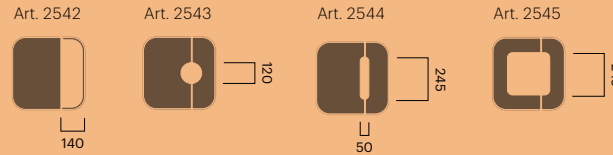

With opening to the side

Art. 2546-900	1 690 EUR / 1 450 GBP	203	2 802
Art. 2546-901	1 420 EUR / 1 210 GBP	203	2 802

Weight: 85/84 kg

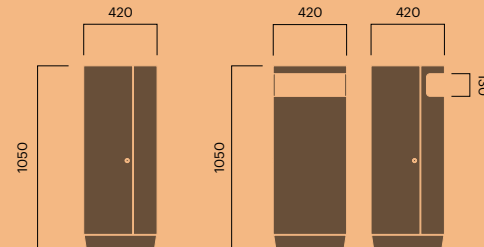

## Forum bicycle rack for 2 bicycles

Anchoring A or C

Small		Kg CO2	MJ
Art. 2584-904A	350 EUR / 300 GBP	18	309
Art. 2584-904C	320 EUR / 275 GBP	21	361

Weight: 20/18 kg

Large		Kg CO2	MJ
Art. 2586-904A	460 EUR / 390 GBP	28	464
Art. 2586-904C	350 EUR / 295 GBP	21	361

Weight: 30/25 kg

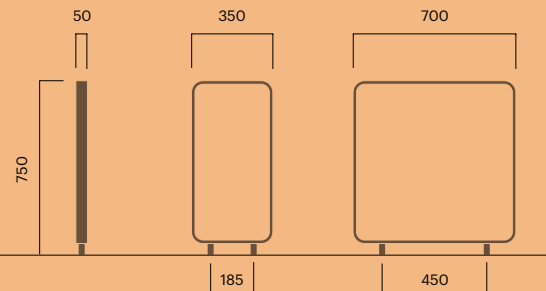

# VESTRE HABITATS

## Decay Edge compost and planter

Square H400		Kg CO2	MJ
Art. 5880-900	1 850 EUR / 1 540 GBP	246	3432
Art. 5880-901	1 720 EUR / 1 430 GBP	246	3432
Art. 5880-903	1 850 EUR / 1 540 GBP		

Square H1000		Kg CO2	MJ
Art. 5884-900	3 590 EUR / 2 990 GBP	615	8580
Art. 5884-901	3 080 EUR / 2 570 GBP	615	8580
Art. 5884-903	3 590 EUR / 2 990 GBP	615	8580

Weight: 105/280 kg

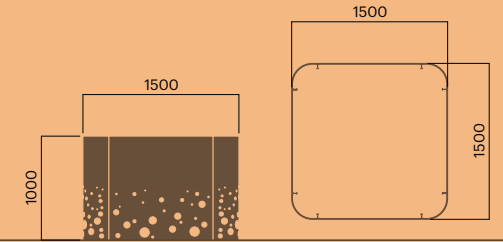

## Decay Edge compost and planter

Circle		Kg CO2	MJ
Art. 5874-900	2 180 EUR / 1 820 GBP	571	7 958
Art. 5874-901	1 780 EUR / 1 480 GBP	571	7 958
Art. 5874-903	2 180 EUR / 1 820 GBP		

Weight: 170 kg

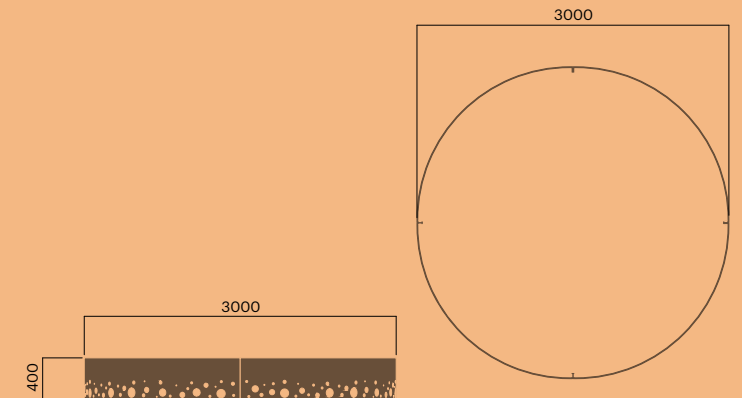

## Decay Edge modules

H400		Kg CO2	MJ
<b>Straight side L1000</b>			
Art. 5850-900	320 EUR / 270 GBP	62	861
Art. 5850-901	270 EUR / 230 GBP	62	861
<b>Straight side L2000</b>			
Art. 5852-900	560 EUR / 470 GBP	95	1 371
Art. 5852-901	460 EUR / 380 GBP	95	1 371

Small 90° radius corner R200		Kg CO2	MJ
Art. 5854-900	190 EUR / 160 GBP	28	388
Art. 5854-901	160 EUR / 130 GBP	28	388

Large 90° radius corner R1470		Kg CO2	MJ
Art. 5858-900	580 EUR / 480 GBP	143	1 995
Art. 5858-901	480 EUR / 400 GBP	143	1 995

Weight: 18/35/8/43 kg

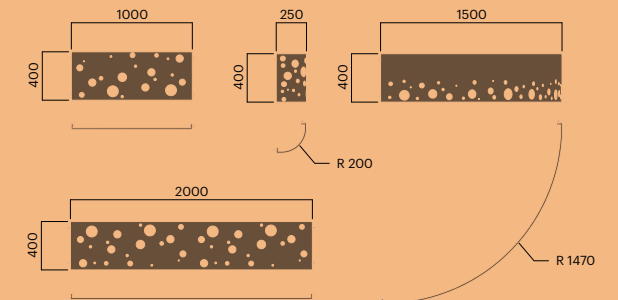

## Decay Edge modules

H1000		Kg CO2	MJ
<b>Straight side L1000</b>			
Art. 5860-900	590 EUR / 490 GBP	162	2 255
Art. 5860-901	490 EUR / 410 GBP	162	2 255
<b>Straight side L2000</b>			
Art. 5862-900	1 150 EUR / 960 GBP	310	4 322
Art. 5862-901	950 EUR / 790 GBP	310	4 322
<b>Small 90° radius corner R200</b>			
Art. 5864-900	350 EUR / 290 GBP	74	1 028
Art. 5864-901	280 EUR / 230 GBP	74	1 028
<b>Large 90° radius corner R1470</b>			
Art. 5868-900	1 380 EUR / 1 150 GBP	370	5 156
Art. 5868-901	1 180 EUR / 980 GBP	370	5 156

Weight: 48/92/22/107 kg

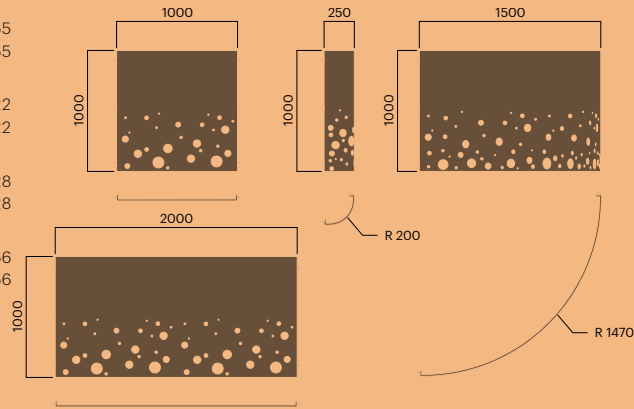

## Leaf insect hotel

Anchoring A or C		Kg CO2	MJ
Art. 5903-900A	390 EUR / 330 GBP	40	558
Art. 5903-901A	290 EUR / 240 GBP	40	558
Art. 5903-900C	360 EUR / 300 GBP	41	577
Art. 5903-901C	260 EUR / 220 GBP	41	577

Weight: 15/16 kg

### Alternative faces and interiors

Perforated front and back		Kg CO2	MJ
Art. 5904-900	290 EUR / 240 GBP	7	103
Art. 5904-901	230 EUR / 190 GBP	7	103

Wood front and back		Kg CO2	MJ
Art. 5906-811	260 EUR / 220 GBP	1	23

Wood bumblebee nest		Kg CO2	MJ
Art. 5907-811	160 EUR / 130 GBP	0	13

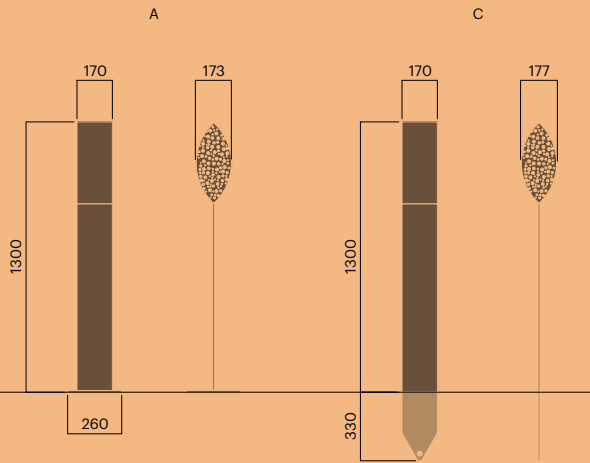

## Leaf insect hotel double

Anchoring A or C		Kg CO2	MJ
Art. 5905-900A	580 EUR / 480 GBP	62	864
Art. 5905-901A	480 EUR / 400 GBP	62	864
Art. 5905-900C	640 EUR / 530 GBP	80	1 119
Art. 5905-901C	540 EUR / 450 GBP	80	1 119

Weight: 19 kg

### Alternative faces and interiors (x2)

Perforated front and back		Kg CO2	MJ
Art. 5904-900	290 EUR / 240 GBP	7	103
Art. 5904-901	230 EUR / 190 GBP	7	103

Wood front and back		Kg CO2	MJ
Art. 5906-811	260 EUR / 220 GBP	1	23

Wood bumblebee nest		Kg CO2	MJ
Art. 5907-811	160 EUR / 130 GBP	0	13



## Log bench for tree trunks

Anchoring A or C		Kg CO2	MJ
Art. 5803-900A	1 750 EUR / 1 460 GBP	317	4 572
Art. 5803-901A	1 550 EUR / 1 290 GBP	317	4 572
Art. 5803-900C	1 850 EUR / 1 540 GBP	345	4 974
Art. 5803-901C	1 650 EUR / 1 380 GBP	345	4 974

Weight: 93 kg

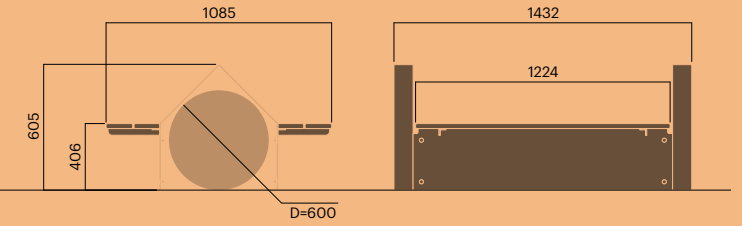

## Pile seat for stone / organic waste

Anchoring A or C		Kg CO2	MJ
Art. 5813-900A	1 780 EUR / 1 480 GBP	237	3 453
Art. 5813-901A	1 560 EUR / 1 300 GBP	237	3 453
Art. 5813-900C	1 880 EUR / 1 570 GBP	251	3 652
Art. 5813-901C	1 660 EUR / 1 380 GBP	251	3 652

Weight: 78 kg

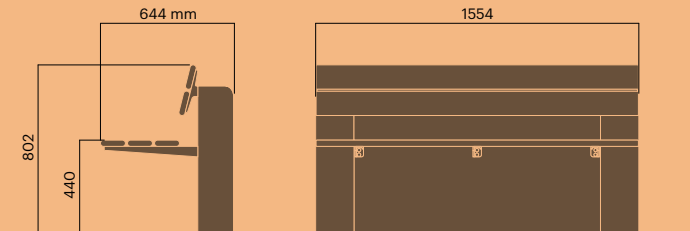

## Wings

Combination of 3 boxes		Kg CO2	MJ
<b>Different sizes and integrated insect hotel</b>			
Art. 5823-900C	2 680 EUR / 2 230 GBP	140	2 166
Art. 5823-901C	2 630 EUR / 2 190 GBP	140	2 166

Wide birdbox		Kg CO2	MJ
Art. 5824-904	780 EUR / 650 GBP	46	771

Narrow birdbox		Kg CO2	MJ
Art. 5825-904	850 EUR / 710 GBP	23	374

Birdbox and insect house		Kg CO2	MJ
Art. 5826-904	860 EUR / 720 GBP	23	381

Weight: 51/18/10/10 kg

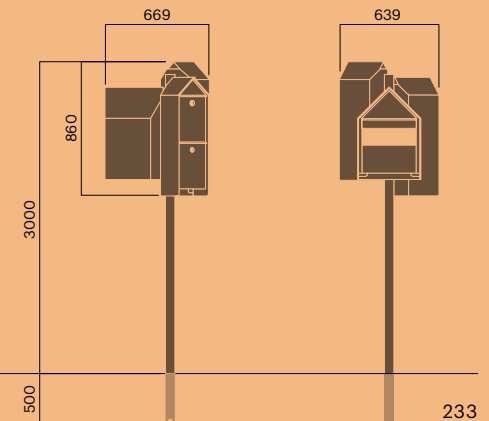

## Wings

### 2m mounting pole

#### anchoring A or C

Art.	Price	Kg CO2	MJ
Art. 5827-900A	260 EUR / 220 GBP	188	2 612
Art. 5827-901A	200 EUR / 170 GBP	188	2 612
Art. 5827-900C	240 EUR / 200 GBP	42	589
Art. 5827-901C	180 EUR / 150 GBP	188	2 612

### 3m mounting pole

#### anchoring A or C

Art.	Price	Kg CO2	MJ
Art. 5828-900A	290 EUR / 240 GBP	204	2 838
Art. 5828-901A	230 EUR / 190 GBP	204	2 838
Art. 5828-900C	270 EUR / 230 GBP	59	831
Art. 5828-901C	210 EUR / 180 GBP	204	2 838

### Large footplate D700 for 2m pole

Art.	Price	Kg CO2	MJ
Art. 5829-900	480 EUR / 400 GBP	151	2 109
Art. 5829-901	410 EUR / 340 GBP	151	2 109

Weight: 11/13/16/18/45 kg

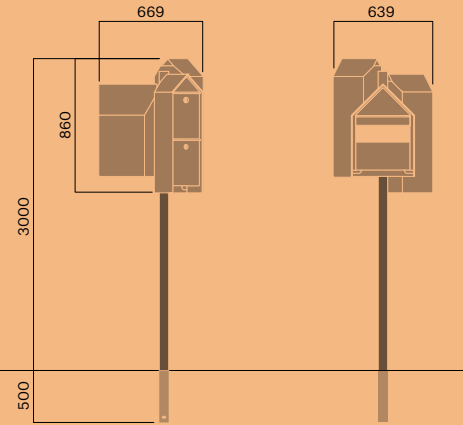

## HVILAN

### Hvilan bench

Art.	Price	Kg CO2	MJ
Art. 106-900	710 EUR / 605 GBP	107	1 680
Art. 106-901	660 EUR / 565 GBP	107	1 680

Weight: 43 kg

#### Option: Extended legs for concreting in place

Art.	Price	Kg CO2	MJ
Art. 101-901	30 EUR / 25 GBP	5	71

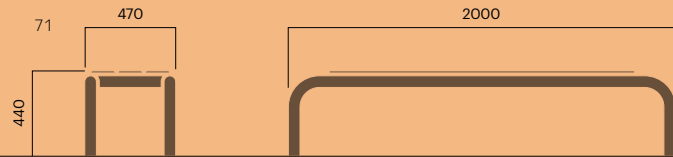

### Hvilan seat

Art.	Price	Kg CO2	MJ
Art. 116-900	1 150 EUR / 985 GBP	140	2 284
Art. 116-901	960 EUR / 820 GBP	140	2 284

Weight: 59 kg

#### Option: Extended legs for concreting in place

Art.	Price	Kg CO2	MJ
Art. 101-901	30 EUR / 25 GBP	5	71

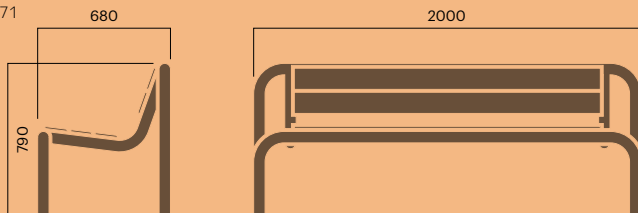

### Hvilan table

Art.	Price	Kg CO2	MJ
Art. 133-900	1 040 EUR / 890 GBP	134	2 194
Art. 133-901	880 EUR / 750 GBP	134	2 194

Weight: 59 kg

#### Option: Extended legs for concreting in place

Art.	Price	Kg CO2	MJ
Art. 101-901	30 EUR / 25 GBP	5	71

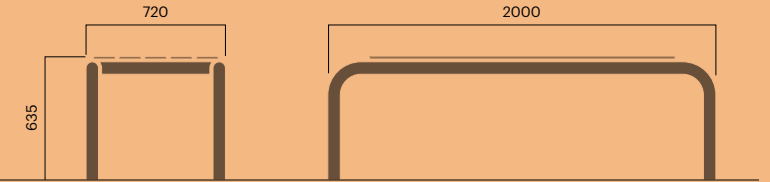

### Hvilan picnic bench table

Art.	Price	Kg CO2	MJ
Art. 122-900	1 560 EUR / 1 330 GBP	161	2 868
Art. 122-901	1 420 EUR / 1 210 GBP	161	2 868

#### Adapted for wheelchair

Art.	Price	Kg CO2	MJ
Art. 122-900HC	1 680 EUR / 1 440 GBP	140	2 754
Art. 122-901HC	1 540 EUR / 1 310 GBP	140	2 754

Weight: 88/93 kg

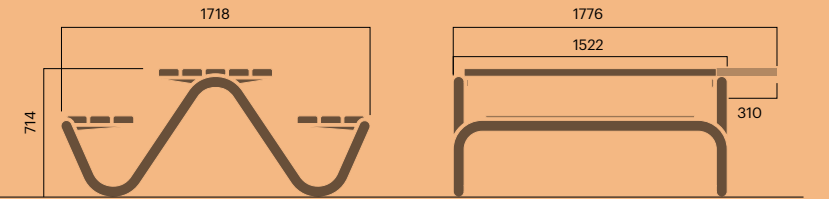

### Hvilan tree barrier

Art.	Price	Kg CO2	MJ
Art. 153-900	740 EUR / 635 GBP	129	1 797
Art. 153-901	610 EUR / 525 GBP	129	1 797

Weight: 39 kg

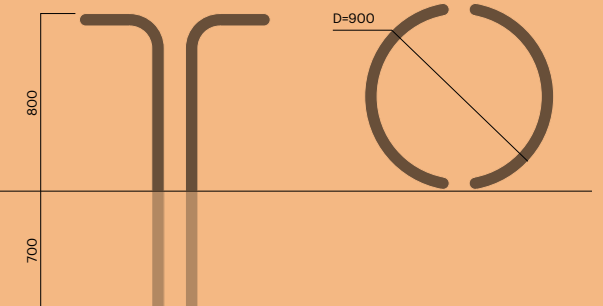

## Hvilan bollard

Model A and C are dimensioned to stop 3.5 tonnes at 18 mph

Anchoring A		Kg CO2	MJ
Art. 185-900A	1 080 EUR / 925 GBP	154	2 149
Art. 185-901A	990 EUR / 850 GBP	154	2 149

Anchoring C		Kg CO2	MJ
Art. 185-900C	720 EUR / 600 GBP	154	2 149
Art. 185-901C	590 EUR / 500 GBP	154	2 149

Demountable		Kg CO2	MJ
Art. 185-900D	1 080 EUR / 920 GBP	157	2 191
Art. 185-901D	990 EUR / 850 GBP	157	2 191

Weight: 47/41/49 kg

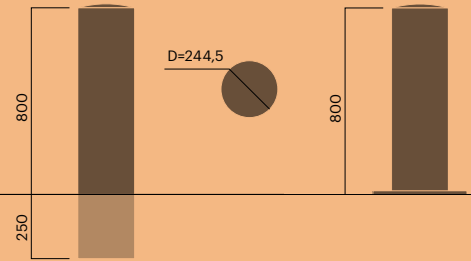

## KINN

### Kinn stackable chair

Art. 6114-904	690 EUR / 580 GBP	Kg CO2	MJ
		67	1 130

Weight: 23 kg

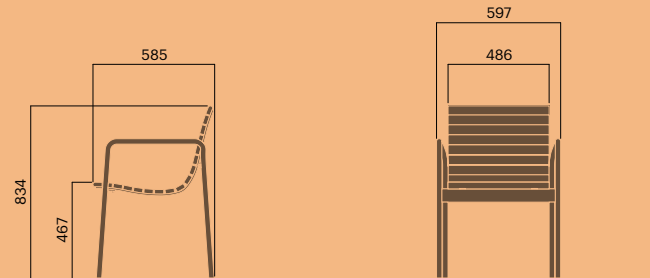

### Kinn stackable lounge chair

Art. 6164-904	890 EUR / 740 GBP	Kg CO2	MJ
		67	1 130

Weight: 29 kg

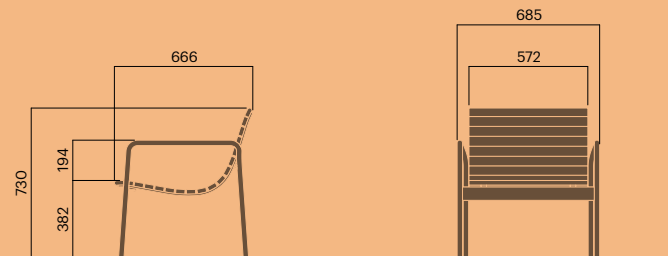

## Kinn 780 table

Square		Kg CO2	MJ
Art. 6130-904	780 EUR / 650 GBP	94	1 646

Weight: 34 kg

Rectangular		Kg CO2	MJ
Art. 6133-904	1 260 EUR / 1 050 GBP	94	1 646

Weight: 46 kg

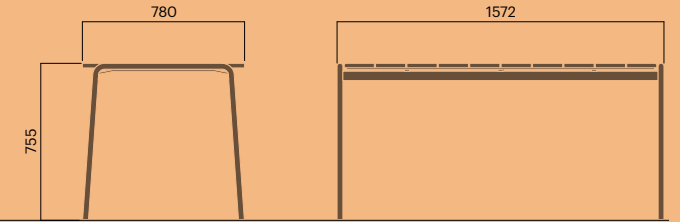

## Kinn 920 table

Adapted for wheelchair

Square		Kg CO2	MJ
Art. 6131-904	980 EUR / 820 GBP	94	1 646

Weight: 52 kg

Rectangular		Kg CO2	MJ
Art. 6136-904	1 580 EUR / 1 320 GBP	144	2 614

Weight: 57 kg

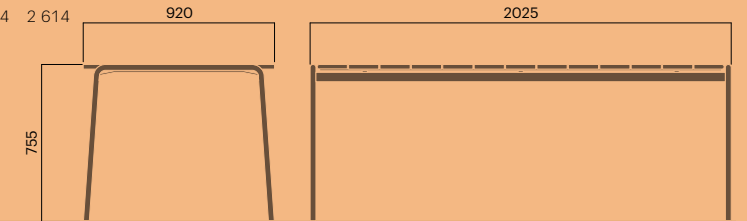

## Kinn 600 lounge table

Square		Kg CO2	MJ
Art. 6134-904	580 EUR / 480 GBP	89	1 580

Weight: 20 kg

Rectangular		Kg CO2	MJ
Art. 6135-904	1 160 EUR / 970 GBP	89	1 580

Weight: 33 kg

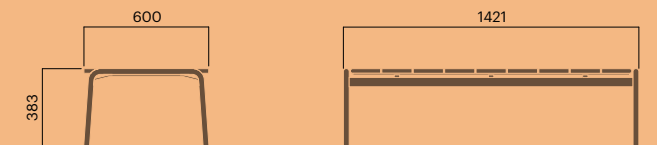



# KONG

## Kong bench

Anchoring A or C		Kg CO2	MJ
Art. 4003-900A	1 720 EUR / 1 470 GBP	166	3 289
Art. 4003-901A	1 480 EUR / 1 260 GBP	166	3 289
Art. 4003-900C	1 780 EUR / 1 520 GBP	203	3 797
Art. 4003-901C	1 520 EUR / 1 300 GBP	203	3 797

Weight: 102/114 kg

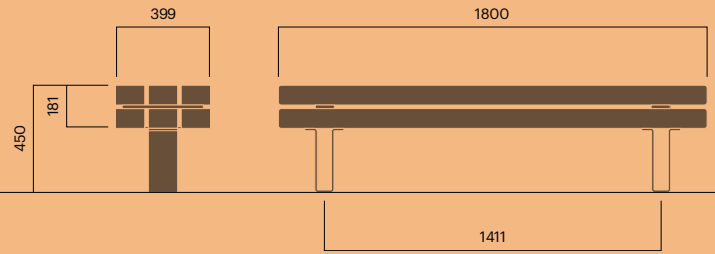

## Kong backrest

		Kg CO2	MJ
Art. 4021-900	780 EUR / 665 GBP	50	888
Art. 4021-901	720 EUR / 615 GBP	50	888

Weight: 24 kg

Armrest		Kg CO2	MJ
Art. 4025-900	200 EUR / 175 GBP	16	229
Art. 4025-901	180 EUR / 155 GBP	16	229

Weight: 9 kg

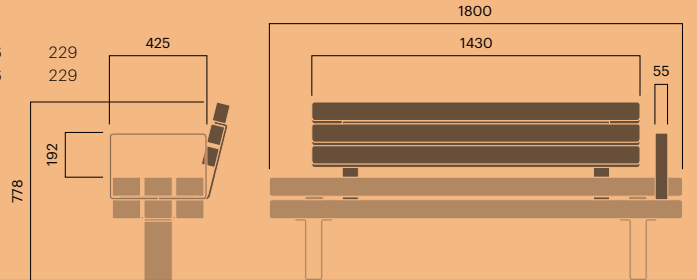

## Kong table

Anchoring A or C		Kg CO2	MJ
Art. 4033-900A	1 850 EUR / 1 580 GBP	340	5 128
Art. 4033-901A	1 650 EUR / 1 420 GBP	340	5 128
Art. 4033-900C	1 960 EUR / 1 670 GBP	396	5 898
Art. 4033-901C	1 760 EUR / 1 510 GBP	396	5 898

Weight: 120 kg

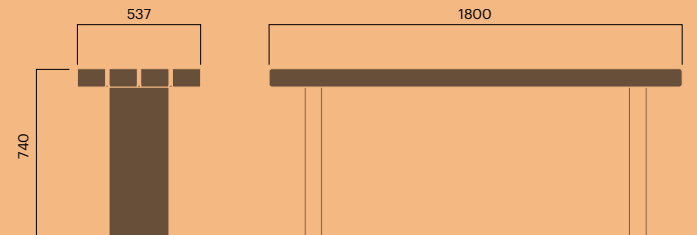

# Kong Cube

Concreting in place		Kg CO2	MJ
Art. 4010-900C	1 290 EUR / 1 110 GBP	88	1 529
Art. 4010-901C	1 120 EUR / 955 GBP	88	1 529

Free-standing		Kg CO2	MJ
Art. 4010-900	1 250 EUR / 1 070 GBP	74	1 336
Art. 4010-901	1 080 EUR / 925 GBP	74	1 336

Weight: 55 kg



## Kong sun bench

Anchoring A or C		Kg CO2	MJ
Art. 4066-900A	3 980 EUR / 3 320 GBP	335	5 662
Art. 4066-901A	3 760 EUR / 3 130 GBP	407	6 661
Art. 4066-900C	3 980 EUR / 3 320 GBP	335	5 662
Art. 4066-901C	3 760 EUR / 3 130 GBP	407	6 661

Weight: 150 kg

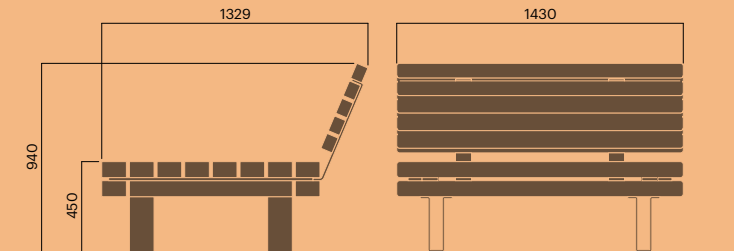

# KYOTO

## Kyoto bench

		Kg CO2	MJ
Art. 2206-004	1 680 EUR / 1 440 GBP	39	1 399

Should be bolted to the ground

Weight: 165 kg

Armrest pair for bench		Kg CO2	MJ
Art. 2226-900	390 EUR / 330 GBP	16	221
Art. 2226-901	340 EUR / 290 GBP	16	221

Weight: 5 kg

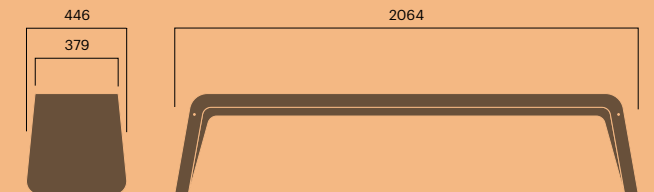

## Kyoto seat

Art. 2216-004 **2 380 EUR / 2 030 GBP** **Kg CO2** 72 **MJ** 2 586

Should be bolted to the ground

Weight: 305 kg

Armrest pair for seat

Art. 2225-900 **390 EUR / 330 GBP** 16 221  
 Art. 2225-901 **340 EUR / 290 GBP** 16 221

Weight: 5 kg

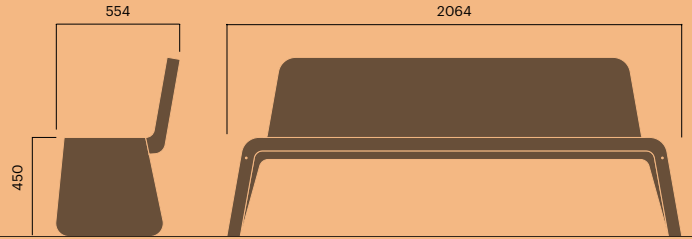

## Kyoto table

Art. 2236-004 **2 850 EUR / 2 430 GBP** **Kg CO2** 105 **MJ** 3 773

Should be bolted to the ground

Weight: 445 kg

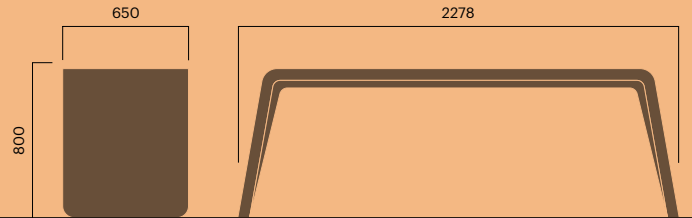

## MOVE

### Move bench

Art. 3106-900 **1 850 EUR / 1 580 GBP** **Kg CO2** 215 **MJ** 3 375  
 Art. 3106-901 **1 690 EUR / 1 440 GBP** 215 3 375

Weight: 87 kg

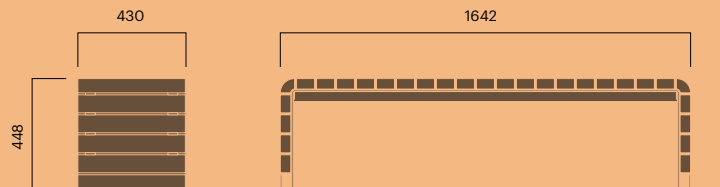

## MUNCH

### Munch bench

**3-seater** **Kg CO2** **MJ**  
 Art. 5106-900 **1 080 EUR / 925 GBP** 110 1 538  
 Art. 5106-901 **960 EUR / 820 GBP** 110 1 538

Weight: 35 kg

Hallingdal cushion set

Art. 5106-409 **780 EUR / 670 GBP**

Outdoor cushions available on request

Available indoor cushion colours:

RAL 5023/Hallingdal 65, 733.  
 RAL 1001/Hallingdal 65, 407.  
 RAL 6014/Hallingdal 65, 350.  
 RAL 3012/Hallingdal 65, 660.  
 RAL 1024/Hallingdal 65, 526.  
 RAL 3009/Hallingdal 65, 687.

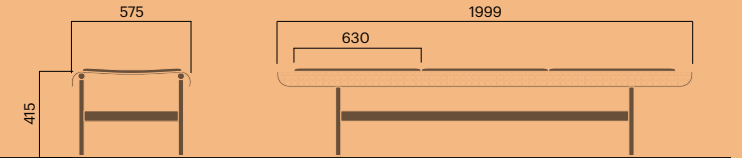

### Munch seat

**3-seater** **Kg CO2** **MJ**  
 Art. 5116-900 **1 480 EUR / 1 260 GBP** 142 1 976  
 Art. 5116-901 **1 280 EUR / 1 100 GBP** 142 1 976

Weight: 45 kg

Hallingdal cushion set

Art. 5116-409 **1 480 EUR / 1 260 GBP**

Outdoor cushions available on request

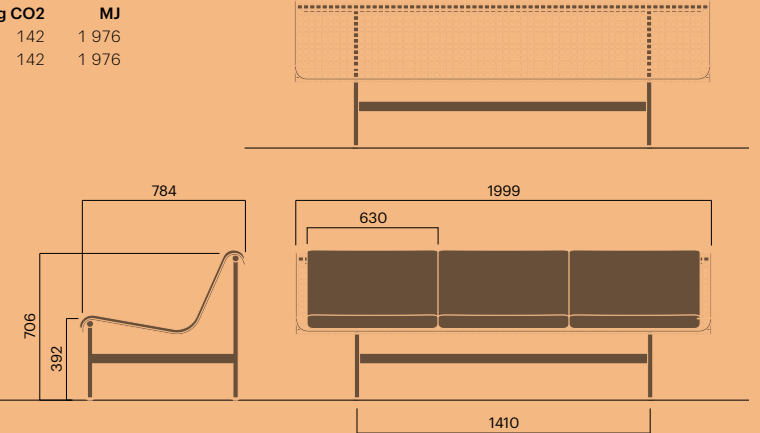

### Munch lounge chair

Art. 5166-900 **1 060 EUR / 900 GBP** **Kg CO2** 73 **MJ** 1 015  
 Art. 5166-901 **940 EUR / 800 GBP** 73 1 015

Weight: 23 kg

Cushion set

Art. 5166-409 **490 EUR / 420 GBP**

Outdoor cushions available on request

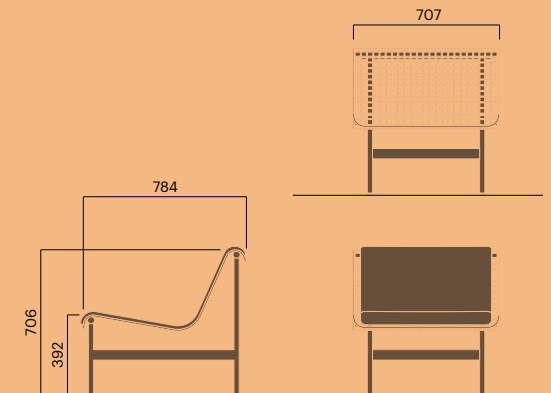

### Munch stackable café chair

		Kg CO2	MJ
Art. 5113-900	370 EUR / 315 GBP	36	497
Art. 5113-901	290 EUR / 245 GBP	36	497

#### Seat cushion

Art. 5113-409	95 EUR / 80 GBP
---------------	-----------------

Weight: 7.5 kg

Outdoor cushions available on request

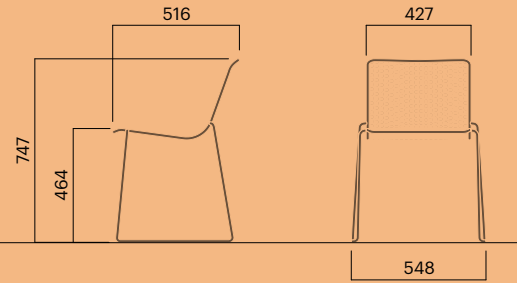

### Munch café table

Round		Kg CO2	MJ
Art. 5132-900	490 EUR / 410 GBP	113	1 577
Art. 5132-901	420 EUR / 350 GBP	113	1 577

#### Square

Art. 5134-900	520 EUR / 430 GBP	113	1 577
Art. 5134-901	450 EUR / 380 GBP	113	1 577

Weight: 36 kg

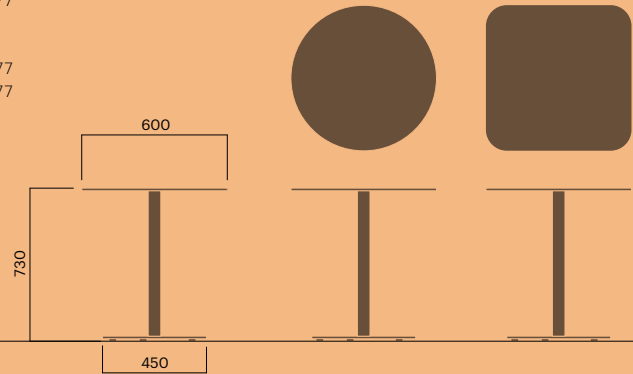

### Munch steel table

Round low		Kg CO2	MJ
Art. 5130-900	470 EUR / 390 GBP	96	1 340
Art. 5130-901	400 EUR / 330 GBP	96	1 340

#### Round high

Art. 5137-900	510 EUR / 430 GBP	100	1 394
Art. 5137-901	440 EUR / 370 GBP	100	1 394

#### Square low

Art. 5131-900	500 EUR / 420 GBP	112	1 556
Art. 5131-901	430 EUR / 360 GBP	112	1 556

#### Square high

Art. 5138-900	540 EUR / 450 GBP	115	1 595
Art. 5138-901	480 EUR / 400 GBP	115	1 595

Weight: 29/31/33/35 kg

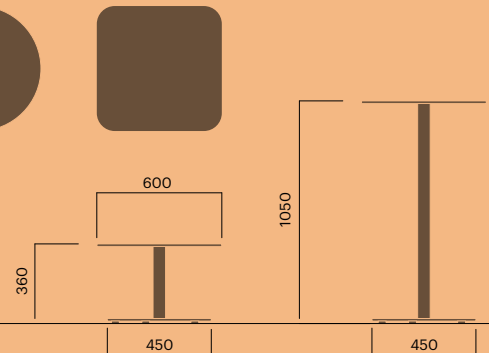

## PARC

### Parc chair

		Kg CO2	MJ
Art. 2318-900	990 EUR / 850 GBP	48	936
Art. 2318-901	870 EUR / 750 GBP	48	936

Weight: 15 kg

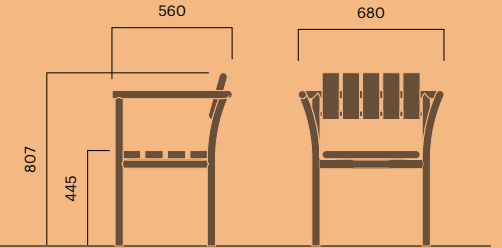

### Parc seat

		Kg CO2	MJ
Art. 2317-900	1 430 EUR / 1 220 GBP	77	1 594
Art. 2317-901	1 300 EUR / 1 110 GBP	77	1 594

Weight: 40 kg

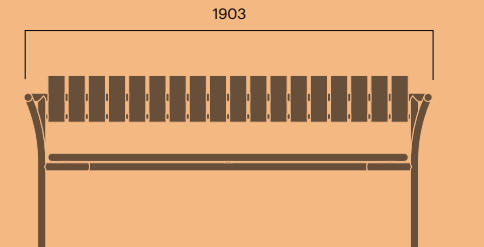

### Parc table

		Kg CO2	MJ
Art. 2336-900	1 140 EUR / 975 GBP	42	817
Art. 2336-901	1 070 EUR / 910 GBP	42	817

Weight: 44 kg

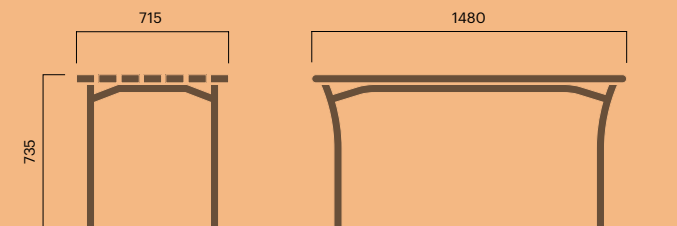

# PARKLETS 2.0

## Parklet Urban floor

**Floor with adjustable feet,**  
fence and transition plate to pavement.  
Easily placed and moved with forklift.

		Kg CO2	MJ
Art. 4470-900	<b>8 800 EUR / 7 510 GBP</b>	1 907	30 345
Art. 4470-901	<b>8 400 EUR / 7 180 GBP</b>	1 907	30 345

**Weight:** 800 kg

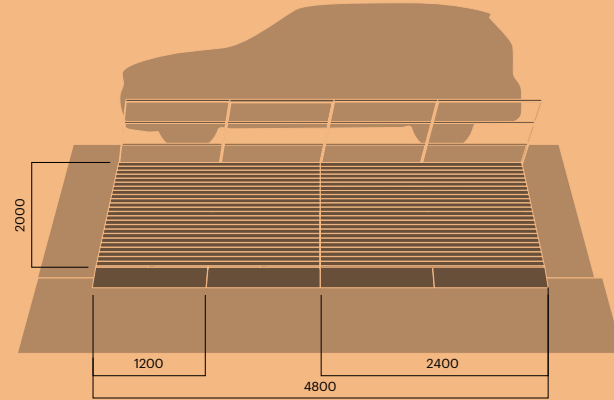

## Parklet Café

**Complete**  
with fence, transition plate to pavement,  
seats, bar table and planter. Easily placed  
and moved with forklift.

		Kg CO2	MJ
Art. 4471-900	<b>19 000 EUR / 16 220 GBP</b>	3 566	52 678
Art. 4471-901	<b>17 500 EUR / 14 940 GBP</b>	3 566	52 678

**Weight:** 1600 kg

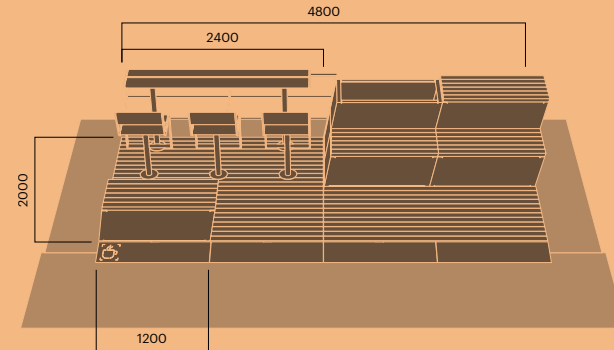

## Parklet Portal

**Complete**  
with transition plate to pavement,  
seats with armrest and planters.  
Easily placed and moved with forklift.

		Kg CO2	MJ
Art. 4472-900	<b>14 500 EUR / 12 380 GBP</b>	3 071	46 965
Art. 4472-901	<b>14 000 EUR / 11 960 GBP</b>	3 071	46 965

**Weight:** 1400 kg

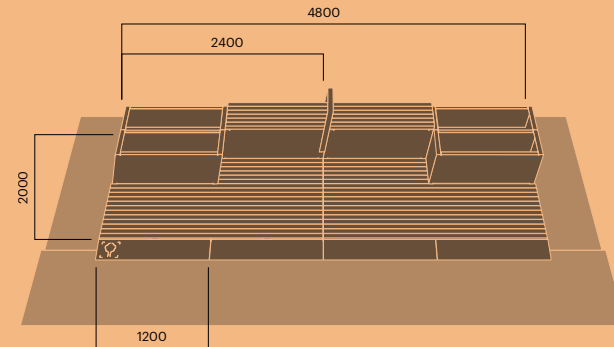

## Parklet Cosy

**Complete**  
with fence, transition plate to pavement,  
planter and sun benches. Easily placed  
and moved with forklift.

		Kg CO2	MJ
Art. 4473-900	<b>13 500 EUR / 11 530 GBP</b>	2 445	39 355
Art. 4473-901	<b>13 000 EUR / 11 100 GBP</b>	2 445	39 355

**Weight:** 1100 kg

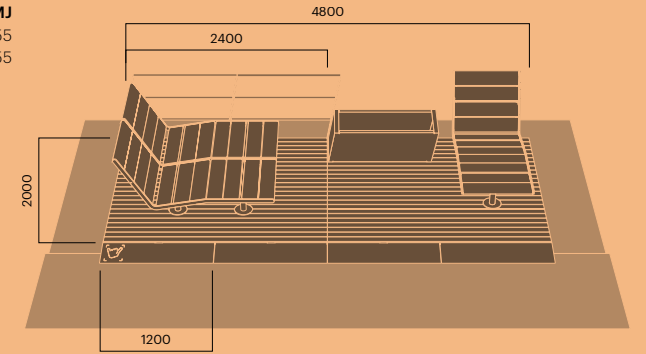

## Parklet Forest

**Combination of small and large planters**  
with integrated seat. Easily placed and  
moved with forklift.

		Kg CO2	MJ
Art. 4474-900	<b>15 000 EUR / 12 810 GBP</b>	3 907	55 326
Art. 4474-901	<b>14 000 EUR / 11 960 GBP</b>	3 907	55 326

**Weight:** 1000 kg

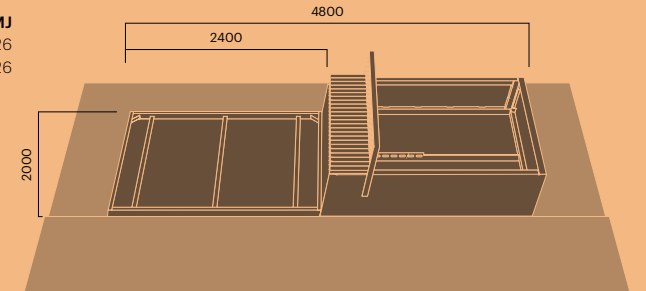

## Parklet Cycling

**Cycle parking**  
with adjustable feet and transition  
plate to pavement. Easily placed  
and moved with forklift.

		Kg CO2	MJ
<b>6 bicycles</b>			
Art. 4475-900	<b>4 000 EUR / 3 410 GBP</b>	1 273	17 912
<b>12 bicycles</b>			
Art. 4476-900	<b>8 000 EUR / 6 840 GBP</b>	3 242	45 515

**Weight:** 250/500 kg

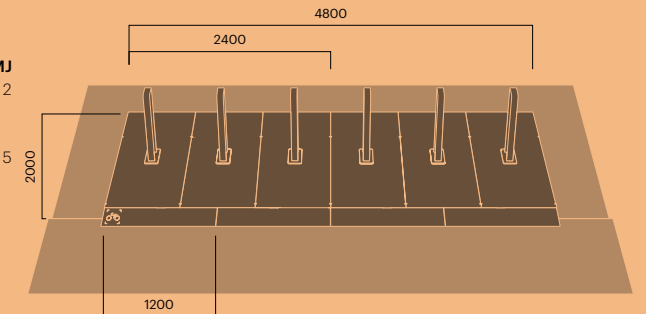

## Parklet Mech

**Floor with adjustable feet,**  
cycle repair stand, seat and transition  
plate to pavement. Easily placed  
and moved with forklift.

		Kg CO2	MJ
Art. 4477-900	<b>8 600 EUR / 7 350 GBP</b>	1 070	16 999
Art. 4477-901	<b>8 200 EUR / 7 000 GBP</b>	1 070	16 999

**Weight:** 346 kg

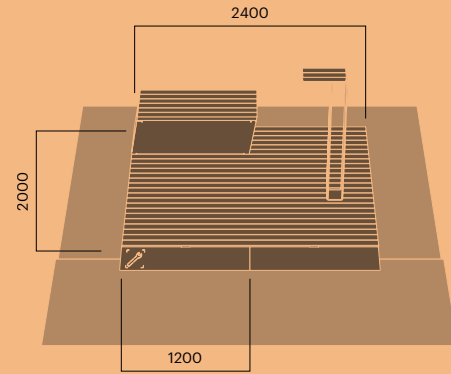

## Parklet floor and fence

Easily placed and moved with forklift

		Kg CO2	MJ
Art. 4401-901	<b>2 950 EUR / 2 520 GBP</b>	708	11 716

<b>Fence length 1200 mm</b>			
		Kg CO2	MJ
Art. 4454-900	<b>440 EUR / 380 GBP</b>	44	610
Art. 4454-901	<b>340 EUR / 285 GBP</b>	44	610

**Weight:** 317/14 kg

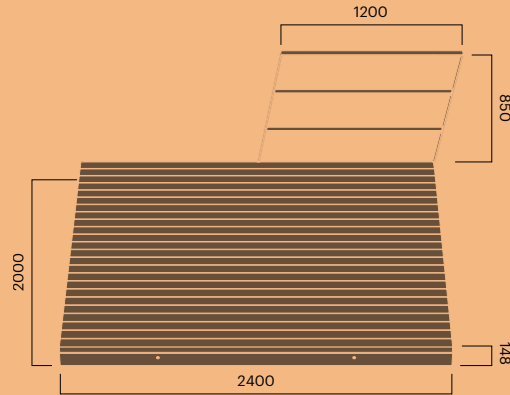

## Parklet transition plate

		Kg CO2	MJ
Art. 4440-901	<b>360 EUR / 310 GBP</b>	72	994

<b>Transition plate with icon</b>			
		Kg CO2	MJ
Art. 4441-901	<b>360 EUR / 310 GBP</b>	67	918
Art. 4442-901	<b>360 EUR / 310 GBP</b>	67	923
Art. 4443-901	<b>360 EUR / 310 GBP</b>	67	918
Art. 4444-901	<b>360 EUR / 310 GBP</b>	67	923
Art. 4445-901	<b>360 EUR / 310 GBP</b>	67	923

**Weight:** 22/21 kg

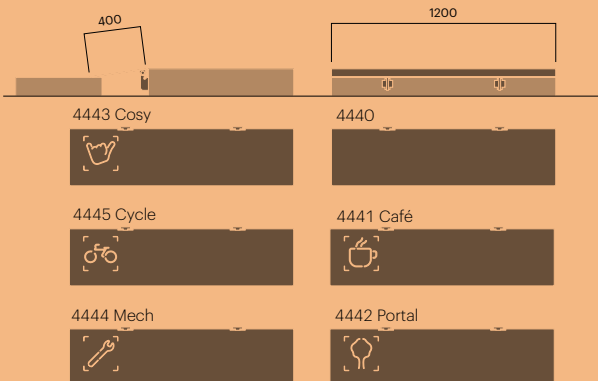

## Parklet seat

		Kg CO2	MJ
Art. 4406-900	<b>1 350 EUR / 1 160 GBP</b>	216	3 243
Art. 4406-901	<b>1 190 EUR / 1 010 GBP</b>	216	3 243

<b>With armrest</b>			
		Kg CO2	MJ
Art. 4407-900	<b>1 480 EUR / 1 260 GBP</b>	229	3 422
Art. 4407-901	<b>1 340 EUR / 1 150 GBP</b>	229	3 422

<b>Without wood</b>			
		Kg CO2	MJ
Art. 4403-900	<b>890 EUR / 760 GBP</b>	189	2 630
Art. 4403-901	<b>780 EUR / 665 GBP</b>	189	2 630

**Weight:** 80/86/60 kg

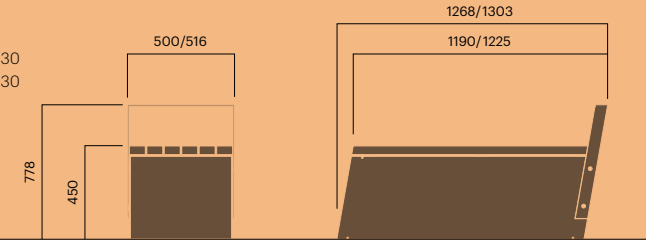

## Parklet small planter

Integrated water reservoir and drainage

		Kg CO2	MJ
Art. 4488-900	<b>1 080 EUR / 925 GBP</b>	227	3 161
Art. 4488-901	<b>980 EUR / 840 GBP</b>	227	3 161

**Weight:** 70 kg

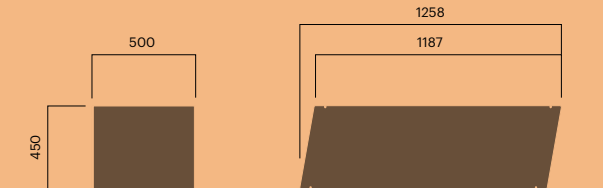

## Parklet large planter

Easily placed and moved with forklift

		Kg CO2	MJ
Art. 4486-901	<b>4 100 EUR / 3 420 GBP</b>	1 210	16 876

<b>High</b>			
		Kg CO2	MJ
Art. 4480-900	<b>8 500 EUR / 7 260 GBP</b>	2 070	28 901
Art. 4480-901	<b>7 800 EUR / 6 500 GBP</b>	2 070	28 901

<b>Seating</b>			
		Kg CO2	MJ
Art. 4420-900MK	<b>1 420 EUR / 1 210 GBP</b>	176	2 848
Art. 4420-901MK	<b>1 320 EUR / 1 130 GBP</b>	176	2 848

<b>Backrest</b>			
		Kg CO2	MJ
Art. 4421-900	<b>1 080 EUR / 900 GBP</b>	101	1 607
Art. 4421-901	<b>970 EUR / 830 GBP</b>	101	1 607

**Weight:** 320/595/47/25 kg

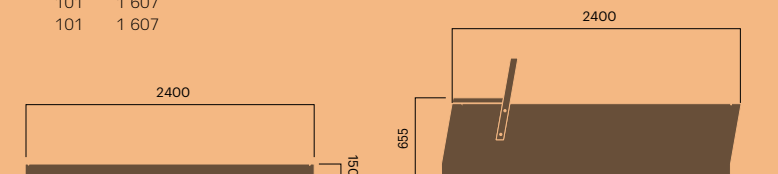

# PLINTH

## Plinth bench

H250 anchoring A and C		Kg CO2	MJ
Art. 5603-900A	740 EUR / 630 GBP	63	1 011
Art. 5603-901A	640 EUR / 550 GBP	63	1 011
Art. 5603-900C	750 EUR / 640 GBP	126	1 887
Art. 5603-901C	650 EUR / 560 GBP	126	1 887

H450 anchoring A and C		Kg CO2	MJ
Art. 5604-900A	950 EUR / 810 GBP	112	1 690
Art. 5604-901A	820 EUR / 700 GBP	112	1 690
Art. 5604-900C	950 EUR / 810 GBP	167	2 459
Art. 5604-901C	820 EUR / 700 GBP	167	2 459

H740 anchoring A and C		Kg CO2	MJ
Art. 5605-900A	1 190 EUR / 1 020 GBP	162	2 393
Art. 5605-901A	1 030 EUR / 880 GBP	162	2 393
Art. 5605-900C	1 190 EUR / 1 020 GBP	227	3 294
Art. 5605-901C	1 030 EUR / 880 GBP	227	3 294

Weight: 34/47 kg / 52/60 kg / 58/79 kg

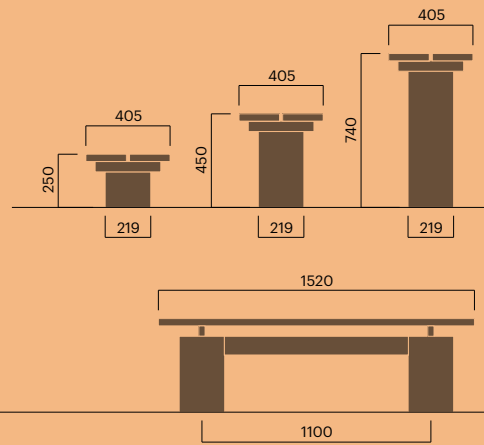

## Plinth long bench

H250 anchoring A and C		Kg CO2	MJ
Art. 5606-900A	1 190 EUR / 1 020 GBP	91	1 504
Art. 5606-901A	1 060 EUR / 910 GBP	91	1 504
Art. 5606-900C	1 190 EUR / 1 020 GBP	188	2 860
Art. 5606-901C	1 060 EUR / 910 GBP	188	2 860

H450 anchoring A and C		Kg CO2	MJ
Art. 5607-900A	1 390 EUR / 1 190 GBP	153	2 367
Art. 5607-901A	1 190 EUR / 1 020 GBP	153	2 367
Art. 5607-900C	1 390 EUR / 1 190 GBP	250	3 724
Art. 5607-901C	1 190 EUR / 1 020 GBP	250	3 724

H740 anchoring A and C		Kg CO2	MJ
Art. 5608-900A	1 570 EUR / 1 340 GBP	243	3 620
Art. 5608-901A	1 350 EUR / 1 150 GBP	243	3 620
Art. 5608-900C	1 570 EUR / 1 340 GBP	340	4 975
Art. 5608-901C	1 350 EUR / 1 150 GBP	340	4 975

Weight: 50/72 kg / 61/92 kg / 89/120 kg

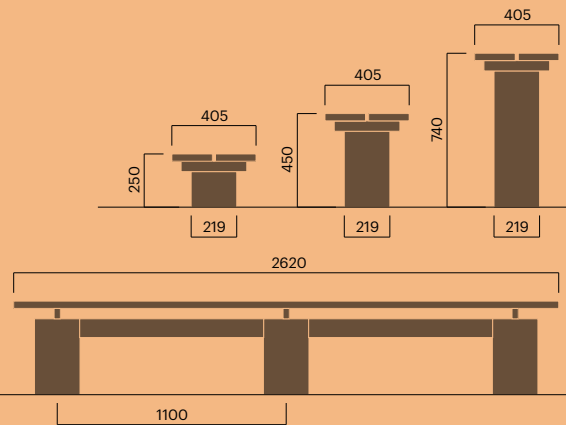

## Plinth seat

Anchoring A and C		Kg CO2	MJ
Art. 5613-900A	1 190 EUR / 1 020 GBP	145	2 149
Art. 5613-901A	990 EUR / 850 GBP	145	2 149
Art. 5613-900C	1 190 EUR / 1 020 GBP	214	3 111
Art. 5613-901C	990 EUR / 850 GBP	214	3 111

## Plinth long seat

Anchoring A and C		Kg CO2	MJ
Art. 5614-900A	1 980 EUR / 1 690 GBP	224	3 353
Art. 5614-901A	1 690 EUR / 1 440 GBP	224	3 353
Art. 5614-900C	1 980 EUR / 1 690 GBP	327	4 794
Art. 5614-901C	1 690 EUR / 1 440 GBP	327	4 794

Weight: 64/75 kg / 83/116 kg

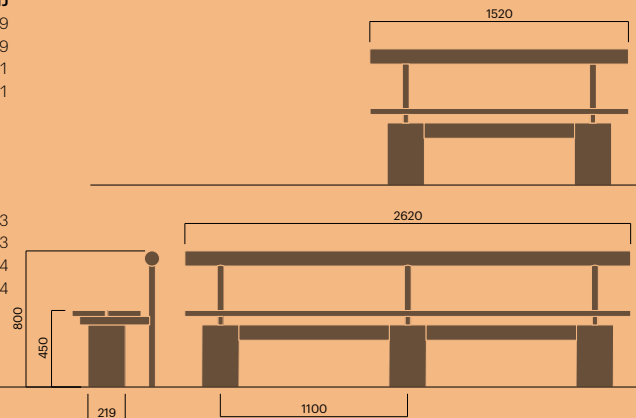

## Plinth table

H250 anchoring A and C		Kg CO2	MJ
Art. 5632-900A	820 EUR / 700 GBP	66	1 116
Art. 5632-901A	720 EUR / 610 GBP	66	1 116
Art. 5632-900C	820 EUR / 700 GBP	131	2 018
Art. 5332-901C	720 EUR / 610 GBP	131	2 018

H450 anchoring A and C		Kg CO2	MJ
Art. 5633-900A	1 020 EUR / 870 GBP	107	1 689
Art. 5633-901A	850 EUR / 730 GBP	107	1 689
Art. 5633-900C	1 020 EUR / 870 GBP	168	2 528
Art. 5633-901C	850 EUR / 730 GBP	168	2 528

H740 anchoring A and C		Kg CO2	MJ
Art. 5634-900A	1 190 EUR / 1 020 GBP	168	2 528
Art. 5634-901A	1 020 EUR / 870 GBP	168	2 528
Art. 5634-900C	1 190 EUR / 1 020 GBP	208	3 096
Art. 5634-901C	1 020 EUR / 870 GBP	208	3 096

Weight: 31/52 kg / 44/65 kg / 63/84 kg

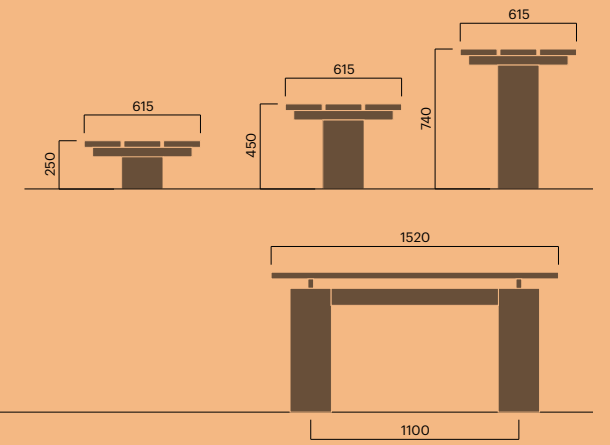

## Plinth long table

H250 anchoring A and C		Kg CO2	MJ
Art. 5635-900A	1 340 EUR / 1 140 GBP	100	1 729
Art. 5635-901A	1 190 EUR / 1 020 GBP	100	1 729
Art. 5635-900C	1 330 EUR / 1 140 GBP	197	3 085
Art. 5635-901C	1 190 EUR / 1 020 GBP	197	3 085

H450 anchoring A and C		Kg CO2	MJ
Art. 5636-900A	1 520 EUR / 1 300 GBP	162	2 592
Art. 5636-901A	1 360 EUR / 1 160 GBP	162	2 592
Art. 5636-900C	1 520 EUR / 1 300 GBP	259	3 949
Art. 5636-901C	1 360 EUR / 1 160 GBP	259	3 949

H740 anchoring A and C		Kg CO2	MJ
Art. 5637-900A	1 720 EUR / 1 470 GBP	252	3 850
Art. 5637-901A	1 480 EUR / 1 260 GBP	252	3 850
Art. 5637-900C	1 720 EUR / 1 470 GBP	349	5 200
Art. 5637-901C	1 480 EUR / 1 260 GBP	349	5 200

Weight: 59/80 kg / 79/100 kg / 111/128 kg

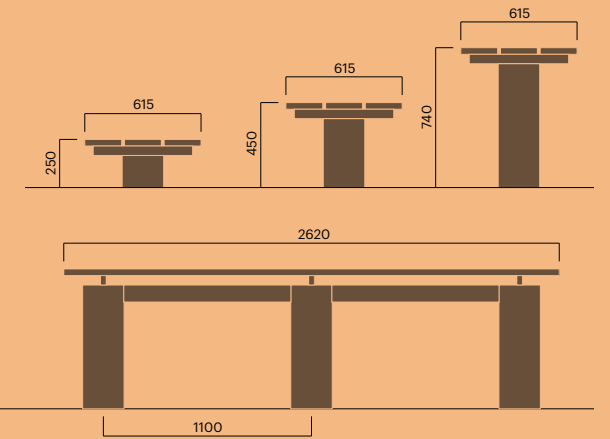

## Plinth cycle rack

Anchoring A and C		Kg CO2	MJ
Art. 5686-900A	330 EUR / 280 GBP	43	600
Art. 5686-901A	260 EUR / 220 GBP	43	600
Art. 5686-900C	330 EUR / 280 GBP	41	573
Art. 5686-901C	270 EUR / 230 GBP	41	573

## Plinth long cycle rack

Anchoring A and C		Kg CO2	MJ
Art. 5687-900A	430 EUR / 370 GBP	78	1 079
Art. 5687-901A	370 EUR / 320 GBP	78	1 079
Art. 5687-900C	430 EUR / 370 GBP	69	957
Art. 5687-901C	370 EUR / 320 GBP	69	957

Weight: 13/22 kg

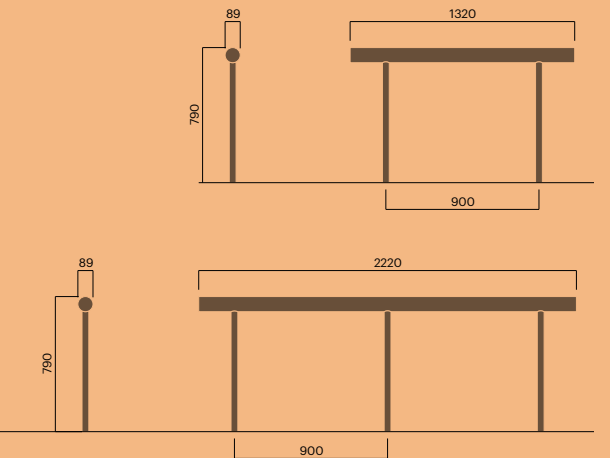

# POP

## Pop bench

		Kg CO2	MJ
Art. 3806-900	680 EUR / 585 GBP	63	910
Art. 3806-901	560 EUR / 480 GBP	63	910

### Seat in high pressure laminate (HPL)

Art. 3806-700	680 EUR / 585 GBP
Art. 3806-701	560 EUR / 480 GBP

Weight: 19/23 kg

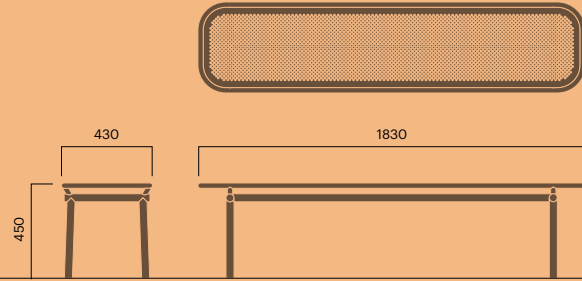

## Pop seat

		Kg CO2	MJ
Art. 3816-900	1 080 EUR / 925 GBP	101	1 462
Art. 3816-901	920 EUR / 790 GBP	101	1 462

### Seat and back in high pressure laminate (HPL)

Art. 3816-700	1 080 EUR / 925 GBP
Art. 3816-701	920 EUR / 790 GBP

Weight: 23/27 kg

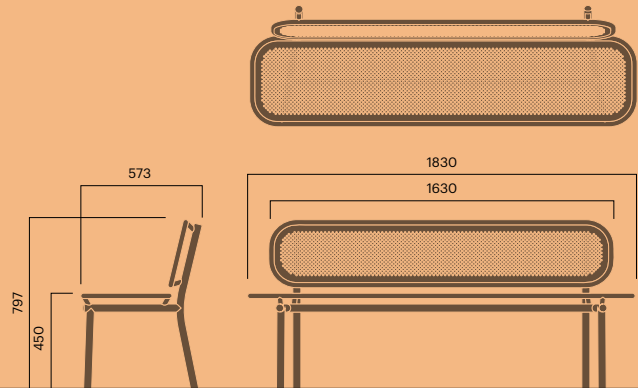

## Pop seat with armrests

		Kg CO2	MJ
Art. 3817-900	1 270 EUR / 1 090 GBP	108	1 565
Art. 3817-901	1 100 EUR / 945 GBP	108	1 565

### Seat and back in high pressure laminate (HPL)

Art. 3817-700	1 270 EUR / 1 090 GBP
Art. 3817-701	1 100 EUR / 945 GBP

Weight: 25/29 kg

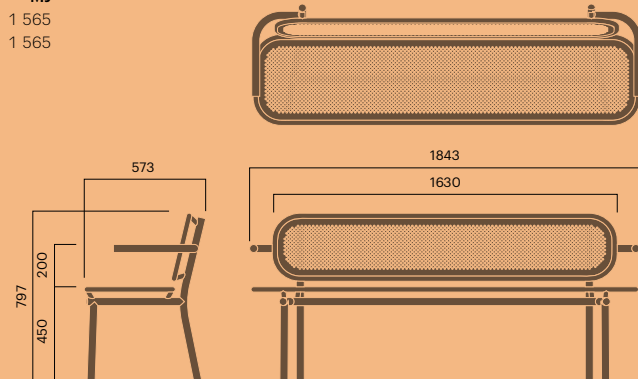

## Pop table

		Kg CO2	MJ
Art. 3836-900	870 EUR / 750 GBP	88	1 286
Art. 3836-901	720 EUR / 615 GBP	88	1 286

### Table top in high pressure laminate (HPL)

Art. 3836-700	870 EUR / 750 GBP
Art. 3836-701	720 EUR / 615 GBP

Weight: 25/29 kg

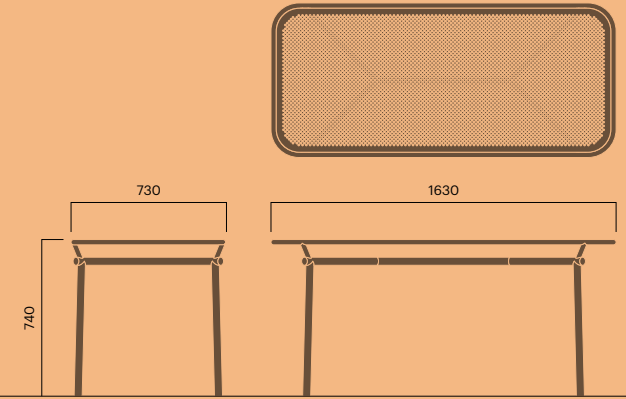

## Pop urban screen #1

		Kg CO2	MJ
Art. 3870-900A	1 190 EUR / 990 GBP	114	1 681
Art. 3870-901A	950 EUR / 790 GBP	114	1 681

Weight: 31 kg

## Pop urban screen #2

Art. 3872-900A	1 350 EUR / 1 130 GBP	128	1 899
Art. 3872-901A	1 040 EUR / 870 GBP	128	1 899

Weight: 35 kg

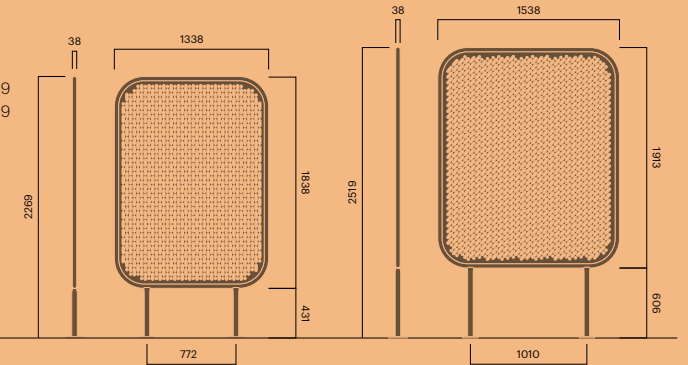

## Pop urban screen #3

		Kg CO2	MJ
Art. 3874-900A	1 270 EUR / 1 060 GBP	128	1 881
Art. 3874-901A	990 EUR / 830 GBP	128	1 881

Weight: 38 kg

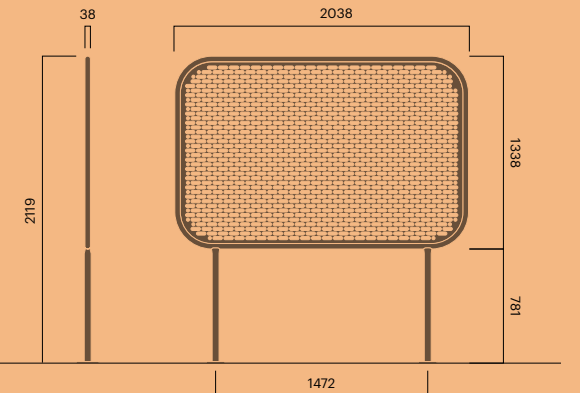

## Pop planter

110 litres

Low		Kg CO2	MJ
Art. 3880-900	960 EUR / 820 GBP	277	3 857
Art. 3880-901	850 EUR / 730 GBP	277	3 857

210 litres

High		Kg CO2	MJ
Art. 3882-900	1 390 EUR / 1 190 GBP	457	6 357
Art. 3882-901	1 250 EUR / 1 070 GBP	457	6 357

Weight: 86/128 kg

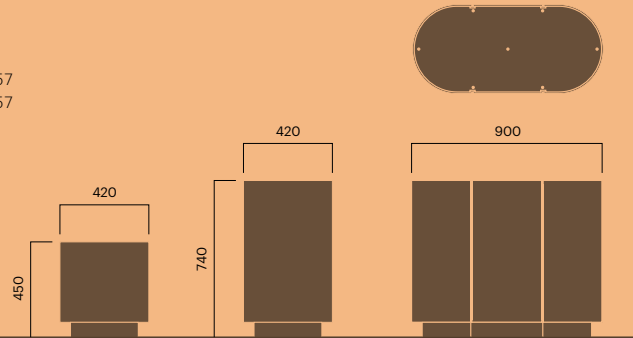

## Pop planter

240 litres

Low		Kg CO2	MJ
Art. 3884-900	1 780 EUR / 1 520 GBP	567	7 892
Art. 3884-901	1 650 EUR / 1 420 GBP	567	7 892

440 litres

High		Kg CO2	MJ
Art. 3886-900	2 390 EUR / 2 040 GBP	819	11 401
Art. 3886-901	2 260 EUR / 1 930 GBP	819	11 401

Weight: 148/246 kg

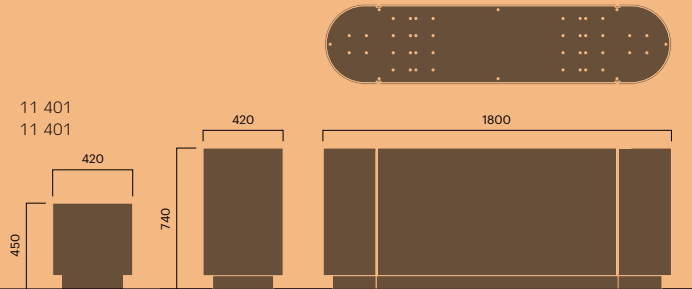

# PORTO

## Porto bench A

Free-standing		Kg CO2	MJ
Art. 401-900	2 290 EUR / 1 960 GBP	135	2 931
Art. 401-901	2 150 EUR / 1 840 GBP	135	2 931

For wall top		Kg CO2	MJ
Art. 401-901MK	1 850 EUR / 1 580 GBP	78	2 122

Weight: 90/70 kg

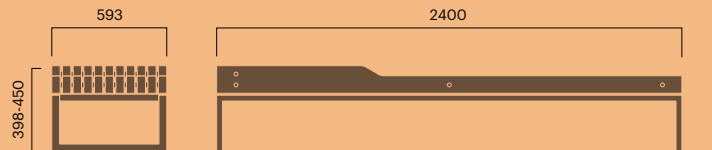

## Porto bench B

Free-standing		Kg CO2	MJ
Art. 402-900	2 290 EUR / 1 960 GBP	149	3 428
Art. 402-901	2 150 EUR / 1 840 GBP	149	3 428

For wall top		Kg CO2	MJ
Art. 402-901MK	1 850 EUR / 1 580 GBP	90	2 604

Weight: 114/94 kg

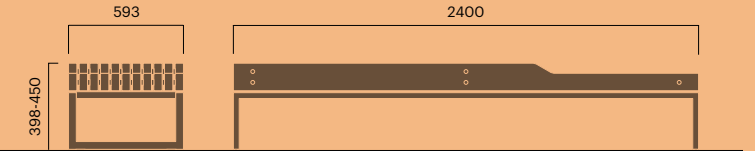

## Porto bench C

Free-standing		Kg CO2	MJ
Art. 403-900	2 290 EUR / 1 960 GBP	149	3 429
Art. 403-901	2 150 EUR / 1 840 GBP	149	3 429

For wall top		Kg CO2	MJ
Art. 403-901MK	1 850 EUR / 1 580 GBP	91	2 590

Weight: 106/86 kg



## Porto bench D

Free-standing		Kg CO2	MJ
Art. 404-900	2 290 EUR / 1 960 GBP	137	2 981
Art. 404-901	2 150 EUR / 1 840 GBP	137	2 981

For wall top		Kg CO2	MJ
Art. 404-901MK	1 850 EUR / 1 580 GBP	79	2 173

Weight: 92/72 kg

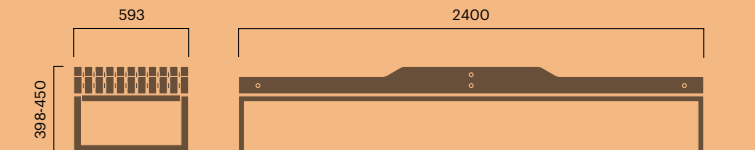



## Porto bench E

Free-standing		Kg CO2	MJ
Art. 405-900	1 890 EUR / 1 620 GBP	126	2 636
Art. 405-901	1 750 EUR / 1 490 GBP	126	2 636

For wall top			
Art. 405-901MK	1 350 EUR / 1 160 GBP	69	1 827

Weight: 80/62 kg



## Porto bench F

Free-standing		Kg CO2	MJ
Art. 406-900	2 190 EUR / 1 880 GBP	156	3 595
Art. 406-901	2 060 EUR / 1 760 GBP	156	3 595

For wall top			
Art. 406-901MK	1 680 EUR / 1 430 GBP	98	2 787

Weight: 113/95 kg



## Porto bench K

Free-standing		Kg CO2	MJ
Art. 407-900	3 480 EUR / 2 970 GBP	151	3 505
Art. 407-901	3 340 EUR / 2 850 GBP	151	3 505

For wall top			
Art. 407-901MK	3 080 EUR / 2 630 GBP	95	2 718

Weight: 130/100 kg

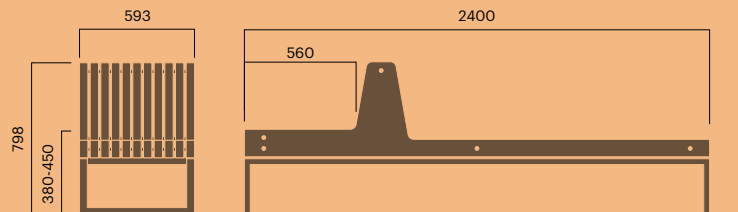

## Porto bench

For wall top

H: 135 mm		Kg CO2	MJ
Art. 420-900MK	840 EUR / 720 GBP	39	1 020
Art. 420-901MK	820 EUR / 700 GBP	39	1 020

H: 187 mm			
Art. 421-900MK	1 020 EUR / 870 GBP	54	1 523
Art. 421-901MK	980 EUR / 840 GBP	54	1 523

Weight: 33/51 kg

Other sizes available on request

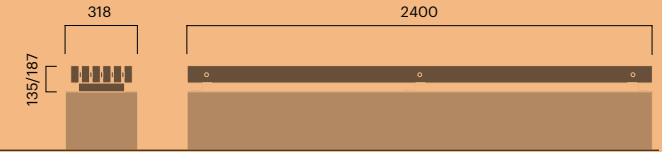

## Porto back and armrest

Back		Kg CO2	MJ
Art. 423-900E	760 EUR / 645 GBP	33	748
Art. 423-901E	680 EUR / 585 GBP	33	748

Weight: 30 kg

Armrest			
Art. 425-900E	200 EUR / 170 GBP	8	116
Art. 425-901E	180 EUR / 150 GBP	8	116

Weight: 3 kg

Back and armrest complete			
Art. 427-900right	480 EUR / 400 GBP	27	410
Art. 427-901right	440 EUR / 370 GBP	27	410
Art. 428-900left	480 EUR / 400 GBP	27	410
Art. 428-901left	440 EUR / 370 GBP	27	410

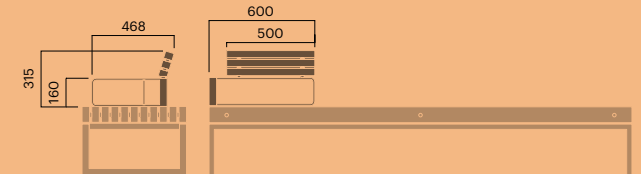
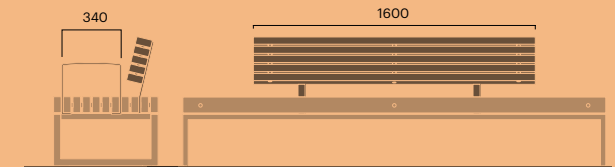

## REALE

### Reale planter

130 litres

Art. rea 065-057 880 EUR / 750 GBP

Weight: 35 kg

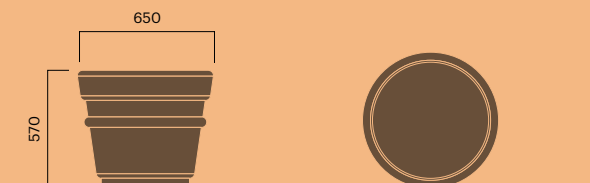

## Reale planter

340 litres

Art. rea 090-090 1 280 EUR / 1 090 GBP

Weight: 75 kg

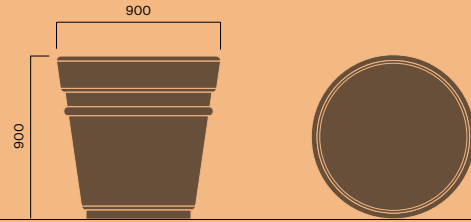

## Reale planter

600 litres

Art. rea 120-070 1 420 EUR / 1 210 GBP

Weight: 80 kg



## Reale planter

1100 litres

Art. rea 130-130 2 750 EUR / 2 350 GBP

Weight: 140 kg

### Options for all planters

Irrigation system on request

Lifting hooks 260 EUR / 220 GBP

Anti-graffiti treatment 170 EUR / 140 GBP

Also available with drainage holes at no extra cost



# SINUS

## Sinus bicycle rack

For 5 bicycles

Anchoring A or C		Kg CO2	MJ
Art. 381-900A	450 EUR / 390 GBP	64	866
Art. 381-901A	380 EUR / 325 GBP	64	866
Art. 381-900C	380 EUR / 325 GBP	65	889
Art. 381-901C	330 EUR / 285 GBP	65	889

Weight: 18 kg

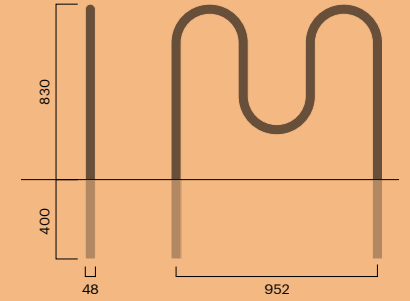

## Sinus bicycle rack

For 7 bicycles

Anchoring A or C		Kg CO2	MJ
Art. 383-900A	520 EUR / 440 GBP	88	1 195
Art. 383-901A	460 EUR / 390 GBP	88	1 195
Art. 383-900C	460 EUR / 390 GBP	90	1 219
Art. 383-901C	380 EUR / 325 GBP	90	1 219

Weight: 24 kg

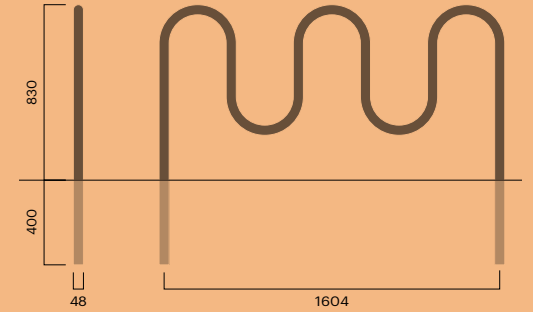

## Sinus bicycle rack

For 9 bicycles

Anchoring A or C		Kg CO2	MJ
Art. 385-900A	620 EUR / 535 GBP	114	1 553
Art. 385-901A	510 EUR / 440 GBP	114	1 553
Art. 385-900C	550 EUR / 470 GBP	116	1 572
Art. 385-901C	450 EUR / 390 GBP	116	1 572

Weight: 31 kg

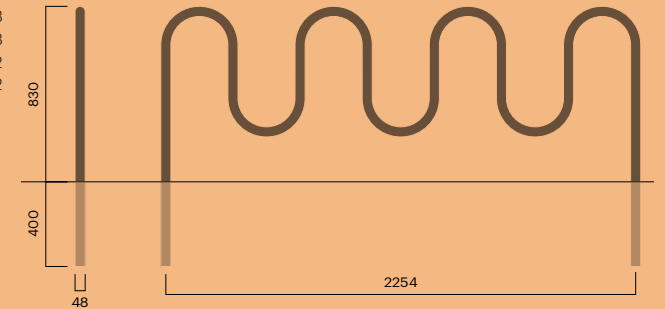

# STONES

## Stones module #1

Bench H450		Kg CO2	MJ
Art. 5202-900	3 460 EUR / 2 950 GBP	315	4 971
Art. 5202-901	2 790 EUR / 2 390 GBP	315	4 971

Bench H600		Kg CO2	MJ
Art. 5204-900	3 620 EUR / 3 100 GBP	347	5 164
Art. 5204-901	2 950 EUR / 2 520 GBP	347	5 164

Planter H400, 320 L		Kg CO2	MJ
Art. 5280-900	2 670 EUR / 2 290 GBP	373	5 197
Art. 5280-901	1 990 EUR / 1 700 GBP	373	5 197

Planter H550, 500 L		Kg CO2	MJ
Art. 5282-900	2 790 EUR / 2 390 GBP	373	5 197
Art. 5282-901	2 160 EUR / 1 850 GBP	373	5 197

Weight: 120/140 kg

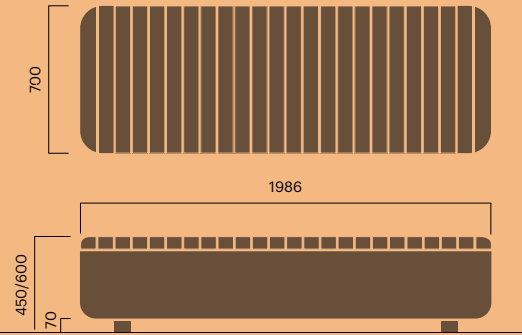

## Stones module #2

Bench H450		Kg CO2	MJ
Art. 5206-900	3 060 EUR / 2 610 GBP	261	3 951
Art. 5206-901	2 460 EUR / 2 100 GBP	261	3 951

Bench H600		Kg CO2	MJ
Art. 5208-900	3 290 EUR / 2 810 GBP	314	4 685
Art. 5208-901	2 620 EUR / 2 240 GBP	314	4 685

Planter H400, 310 L		Kg CO2	MJ
Art. 5284-900	2 480 EUR / 2 120 GBP	326	4 545
Art. 5284-901	1 880 EUR / 1 610 GBP	326	4 545

Planter H550, 490 L		Kg CO2	MJ
Art. 5286-900	2 760 EUR / 2 360 GBP	375	5 220
Art. 5286-901	2 060 EUR / 1 760 GBP	375	5 220

Weight: 100/120 kg

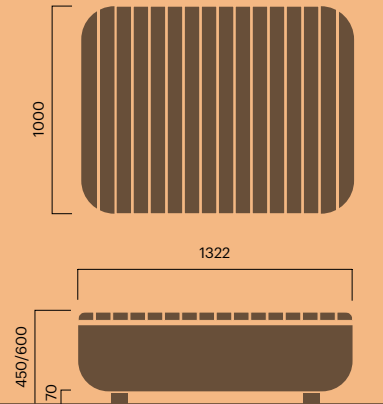

## Stones module #3

Bench H450		Kg CO2	MJ
Art. 5210-900	3 680 EUR / 3 150 GBP	348	5 352
Art. 5210-901	2 990 EUR / 2 550 GBP	348	5 352

Bench H600		Kg CO2	MJ
Art. 5212-900	3 850 EUR / 3 290 GBP	415	6 290
Art. 5212-901	3 190 EUR / 2 730 GBP	415	6 290

Planter H400, 540 L		Kg CO2	MJ
Art. 5288-900	2 890 EUR / 2 470 GBP	460	6 412
Art. 5288-901	2 280 EUR / 1 950 GBP	460	6 412

Planter H550, 840 L		Kg CO2	MJ
Art. 5290-900	3 080 EUR / 2 630 GBP	524	7 294
Art. 5290-901	2 460 EUR / 2 100 GBP	524	7 294

Weight: 140/160 kg

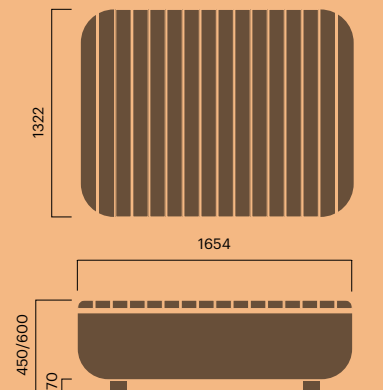

# STOOP

## Stoop mini

		Kg CO2	MJ
Art. 2413-900	2 980 EUR / 2 480 GBP	507	7 275
Art. 2413-901	2 580 EUR / 2 150 GBP	507	7 275

Weight: 161 kg

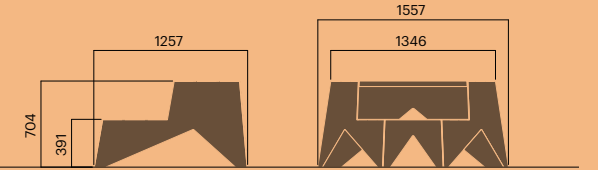

## Stoop bench

		Kg CO2	MJ
Art. 2417-900	4 250 EUR / 3 630 GBP	615	9 168
Art. 2417-901	3 480 EUR / 2 970 GBP	615	9 168

Weight: 226 kg

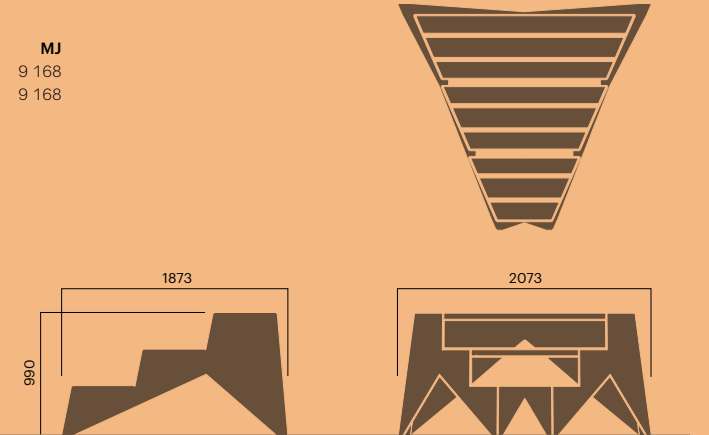

## Stoop picnic table

		Kg CO2	MJ
Art. 2422-900	3 250 EUR / 2 710 GBP	442	6 898
Art. 2422-901	2 950 EUR / 2 460 GBP	442	6 898

Weight: 169 kg

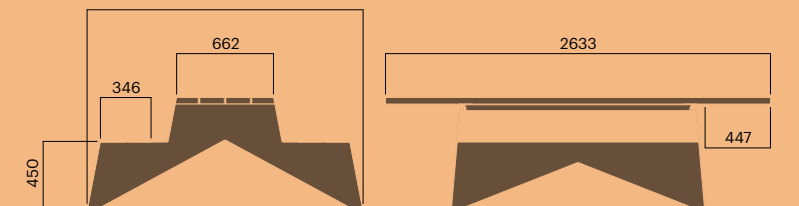

# STRIPES

## Stripes bench rectangular

		Kg CO2	MJ
Art. 3606-900	2 140 EUR / 1 830 GBP	151	2 713
Art. 3606-901	1 980 EUR / 1 690 GBP	151	2 713

Weight: 79 kg

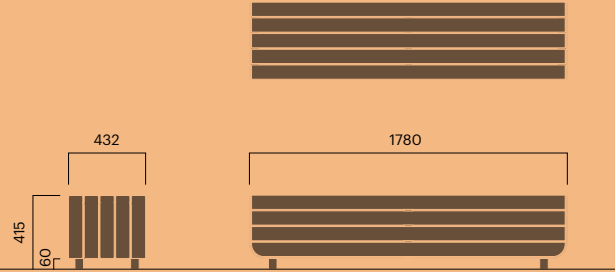

## Stripes bench modules

Start and end		Kg CO2	MJ
Art. 3607-900	1 820 EUR / 1 560 GBP	142	2 413
Art. 3607-901	1 620 EUR / 1 380 GBP	142	2 413

Weight: 71 kg

Add-on module		Kg CO2	MJ
Art. 3608-900	1 460 EUR / 1 250 GBP	136	2 165
Art. 3608-901	1 240 EUR / 1 060 GBP	136	2 165

Weight: 56 kg

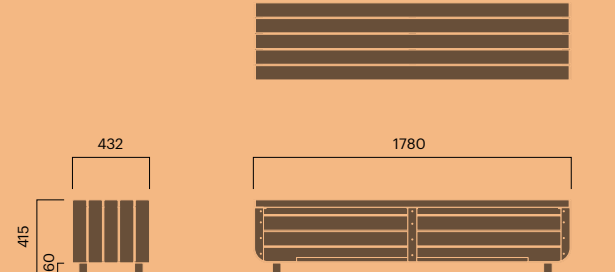

## Stripes bench aperture modules

The aperture can be on the right (H), left (V) or in the middle (M)

Start and end		Kg CO2	MJ
Art. 3607-900H	2 360 EUR / 2 020 GBP	180	2 932
Art. 3607-901H	2 180 EUR / 1 870 GBP	180	2 932
Art. 3607-900M	2 360 EUR / 2 020 GBP	177	2 885
Art. 3607-901M	2 180 EUR / 1 870 GBP	177	2 885
Art. 3607-900V	2 360 EUR / 2 020 GBP	180	2 932
Art. 3607-901V	2 180 EUR / 1 870 GBP	180	2 932

Add-on module		Kg CO2	MJ
Art. 3608-900H	2 110 EUR / 1 800 GBP	172	2 612
Art. 3608-901H	1 920 EUR / 1 640 GBP	172	2 612
Art. 3608-900M	2 110 EUR / 1 800 GBP	166	2 528
Art. 3608-901M	1 920 EUR / 1 640 GBP	166	2 528
Art. 3608-900V	2 110 EUR / 1 800 GBP	172	2 612
Art. 3608-901V	1 920 EUR / 1 640 GBP	172	2 612

Weight: 78/65 kg

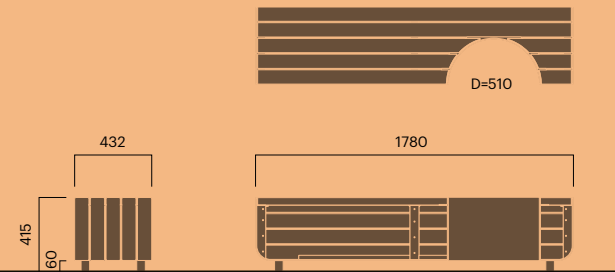

## Stripes circle bench small

		Kg CO2	MJ
Art. 3612-900	3 390 EUR / 2 900 GBP	324	4 761
Art. 3612-901	2 980 EUR / 2 540 GBP	324	4 761

Weight: 107 kg

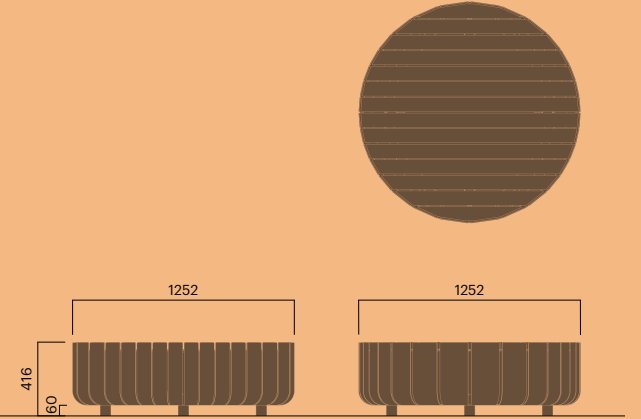

## Stripes circle bench large

		Kg CO2	MJ
Art. 3610-900	3 980 EUR / 3 400 GBP	459	7 193
Art. 3610-901	3 450 EUR / 2 950 GBP	459	7 193

Weight: 184 kg

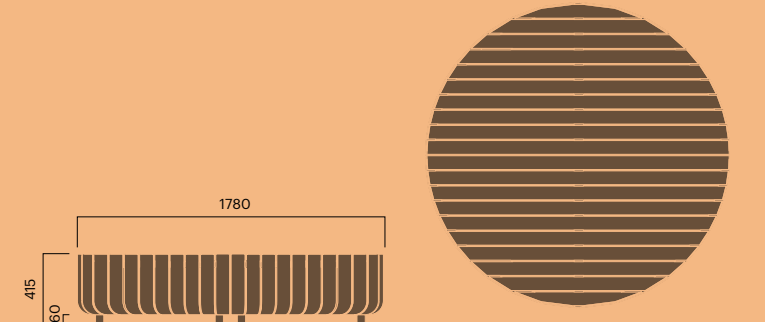

## Stripes circle bench with plant aperture

The aperture can be on the right (H), left (V) or in the middle (M)

		Kg CO2	MJ
Art. 3611-900M	5 650 EUR / 4 830 GBP	518	8 012
Art. 3611-901M	4 980 EUR / 4 250 GBP	518	8 012
Art. 3611-900HV	5 650 EUR / 4 830 GBP	537	8 285
Art. 3611-901HV	4 980 EUR / 4 250 GBP	537	8 285

Weight: 210 kg

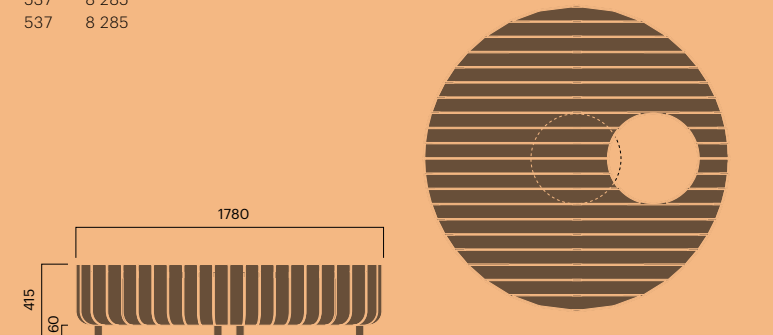

## Stripes bench semicircle

Closed module		Kg CO2	MJ
Art. 3617-900	2 390 EUR / 2 040 GBP	236	3 858
Art. 3617-901	2 150 EUR / 1 830 GBP	236	3 858

Weight: 104 kg

Open module		Kg CO2	MJ
Art. 3616-900	1 980 EUR / 1 690 GBP	228	3 581
Art. 3616-901	1 730 EUR / 1 480 GBP	228	3 581

Weight: 92 kg

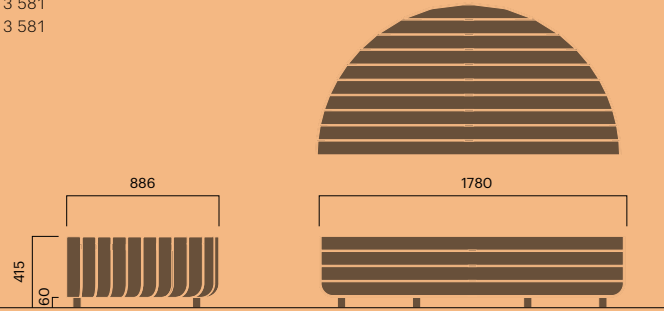

## Stripes bench open semicircle with plant aperture

The aperture can be on the right (H), left (V) or in the middle (M)

		Kg CO2	MJ
Art. 3616-900H	2 830 EUR / 2 420 GBP	269	4 142
Art. 3616-901H	2 490 EUR / 2 130 GBP	269	4 142
Art. 3616-900M	2 830 EUR / 2 420 GBP	261	4 058
Art. 3616-901M	2 490 EUR / 2 130 GBP	261	4 058
Art. 3616-900V	2 830 EUR / 2 420 GBP	269	4 142
Art. 3616-901V	2 490 EUR / 2 130 GBP	269	4 142

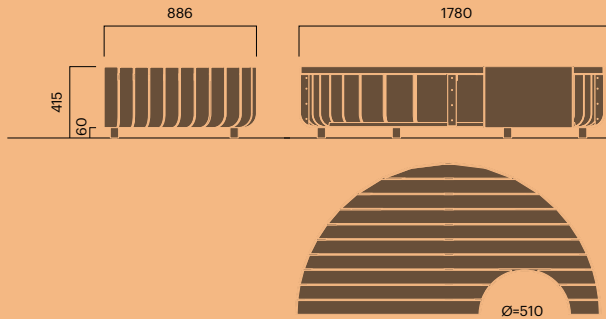

Weight: 105/102 kg

## Stripes planter small

170 litres

Low		Kg CO2	MJ
Art. 3678-900	2 980 EUR / 2 480 GBP	478	6 665
Art. 3678-901	2 480 EUR / 2 120 GBP	478	6 665

440 litres

High		Kg CO2	MJ
Art. 3674-900	3 980 EUR / 3 320 GBP	734	10 230
Art. 3674-901	3 480 EUR / 2 900 GBP	734	10 230

Weight: 136/210 kg

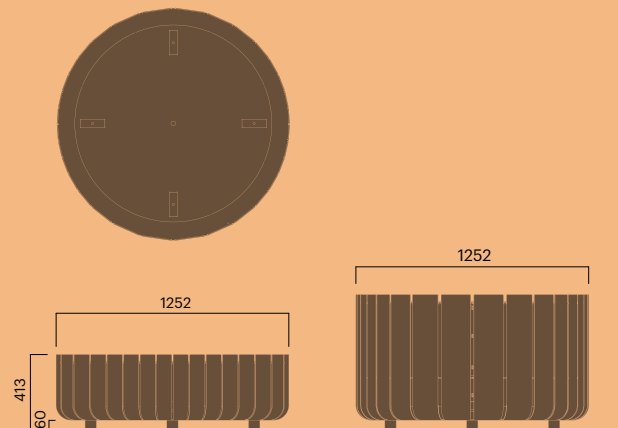

## Stripes planter large

450 litres

		Kg CO2	MJ
Art. 3684-900	4 750 EUR / 4 060 GBP	894	12 457
Art. 3684-901	4 250 EUR / 3 540 GBP	894	12 457

Weight: 230 kg

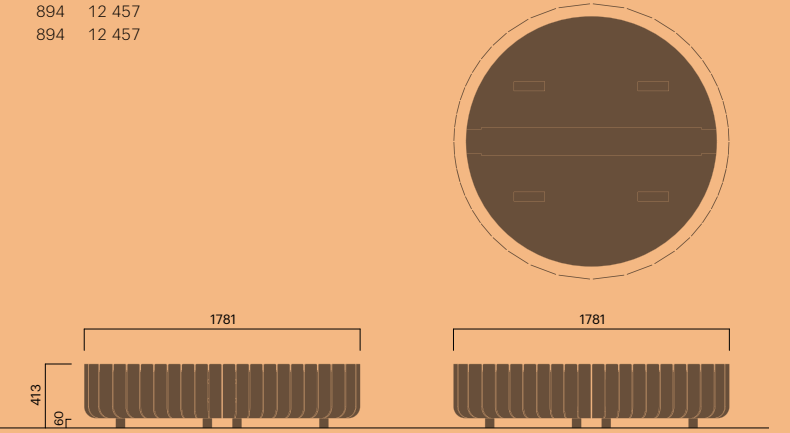

## Stripes semicircle planter

225 litres

Closed module		Kg CO2	MJ
Art. 3683-900	2 980 EUR / 2 480 GBP	515	7 168
Art. 3683-901	2 480 EUR / 2 070 GBP	515	7 168

Weight: 160 kg

Open module for connection

Art. 3682-900	2 380 EUR / 1 980 GBP	454	6 324
Art. 3682-901	2 120 EUR / 1 770 GBP	454	6 324

Weight: 143 kg

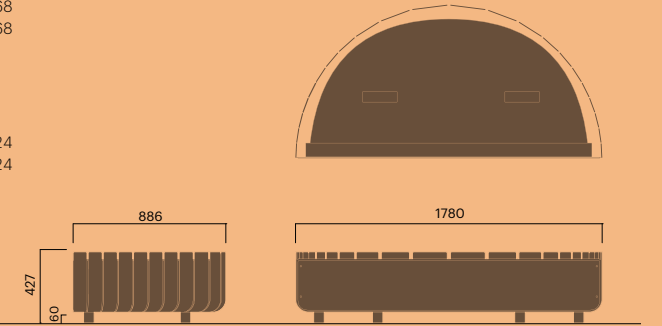

## TOUR

### Tour bicycle rack

For 2 bicycles

Anchoring A or C		Kg CO2	MJ
Art. 2886-900A	390 EUR / 340 GBP	75	1 046
Art. 2886-901A	320 EUR / 275 GBP	75	1 046
Art. 2886-900C	380 EUR / 330 GBP	92	1 276
Art. 2886-901C	310 EUR / 265 GBP	92	1 276

Weight: 30 kg

Other patterns on request

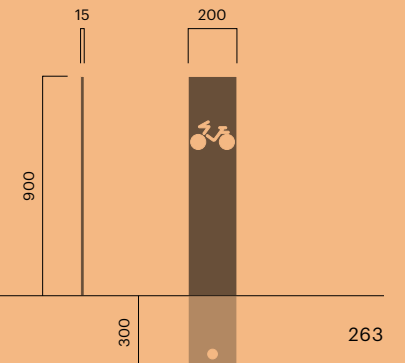

# URBAN

## Anchoring options

A: anchoring with base plate

B: wall-mounted

C: concreting in place

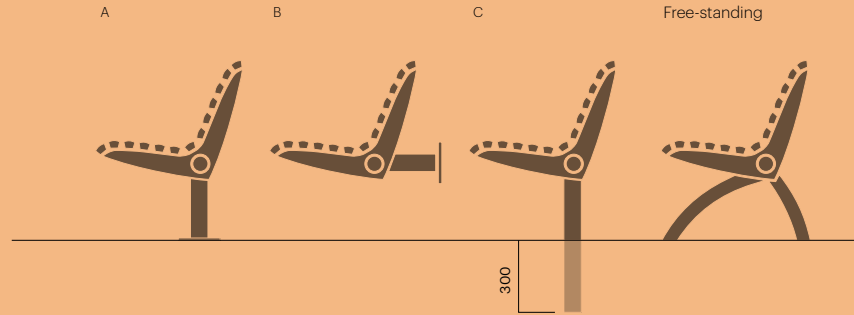

## Urban bench

### Narrow bench, anchoring A or C

Art.	Price	Kg CO2	MJ
Art. 503-900A	850 EUR / 730 GBP	69	1 192
Art. 503-901A	730 EUR / 620 GBP	69	1 192
Art. 503-900C	850 EUR / 730 GBP	76	1 286
Art. 503-901C	730 EUR / 620 GBP	76	1 286

### Wide bench, anchoring A or C

Art.	Price	Kg CO2	MJ
Art. 504-900A	880 EUR / 750 GBP	73	1 306
Art. 504-901A	810 EUR / 695 GBP	73	1 306
Art. 504-900C	880 EUR / 750 GBP	81	1 409
Art. 504-901C	810 EUR / 695 GBP	81	1 409

Weight: 35/40 kg

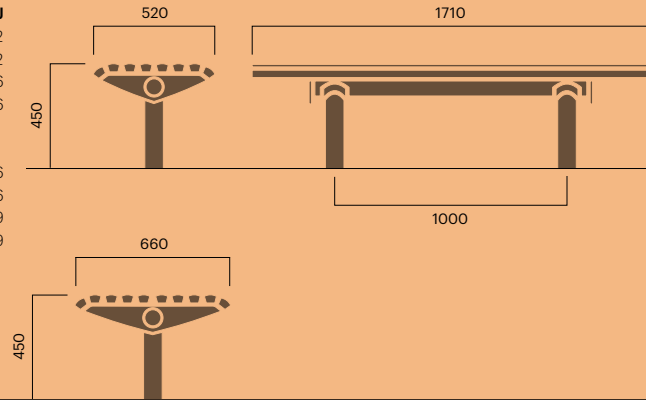

## Urban bench

### Narrow bench, free-standing

Art.	Price	Kg CO2	MJ
Art. 506-900	890 EUR / 760 GBP	80	1 347
Art. 506-901	760 EUR / 645 GBP	80	1 347

### Wide bench, free-standing

Art.	Price	Kg CO2	MJ
Art. 507-900	990 EUR / 850 GBP	85	1 475
Art. 507-901	860 EUR / 740 GBP	85	1 475

Weight: 36/40 kg

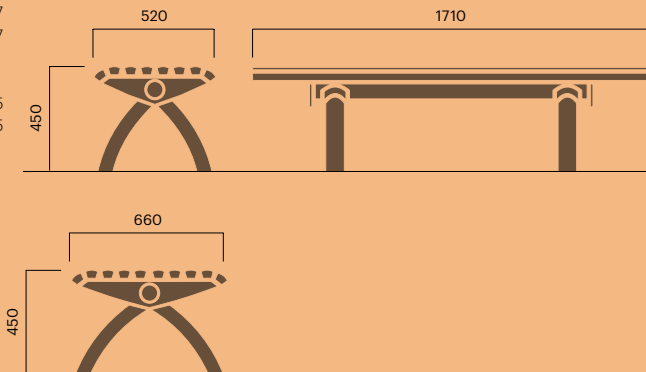

## Urban bench

### Narrow bench, with granite pedestals

Art.	Price	Kg CO2	MJ
Art. 508-900	1 490 EUR / 1 240 GBP	87	1 945
Art. 508-901	1 350 EUR / 1 130 GBP	87	1 945

### Wide bench, with granite pedestals

Art.	Price	Kg CO2	MJ
Art. 509-900	1 590 EUR / 1 330 GBP	92	2 074
Art. 509-901	1 450 EUR / 1 210 GBP	92	2 074

Weight: 100/104 kg

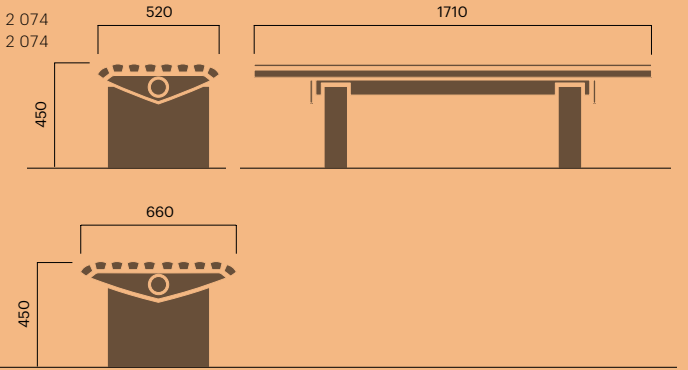

## Urban armrest for bench

### Armrest pair

Art.	Price	Kg CO2	MJ
Art. 526-900	250 EUR / 215 GBP	17	236
Art. 526-901	190 EUR / 165 GBP	17	236

Weight: 4 kg

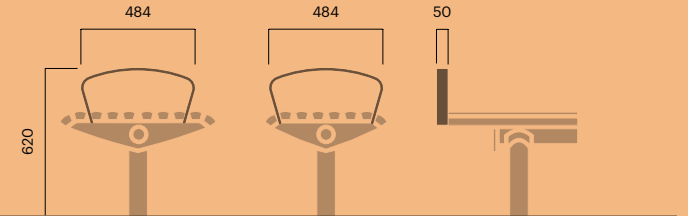

## Urban seat

### Anchoring A, B or C

Art.	Price	Kg CO2	MJ
Art. 513-900A	1 080 EUR / 925 GBP	82	1 508
Art. 513-901A	940 EUR / 800 GBP	82	1 508
Art. 513-900B	1 080 EUR / 925 GBP	82	1 508
Art. 513-901B	940 EUR / 800 GBP	82	1 508
Art. 513-900C	1 080 EUR / 925 GBP	87	1 424
Art. 513-901C	940 EUR / 800 GBP	87	1 424

Weight: 44/46 kg

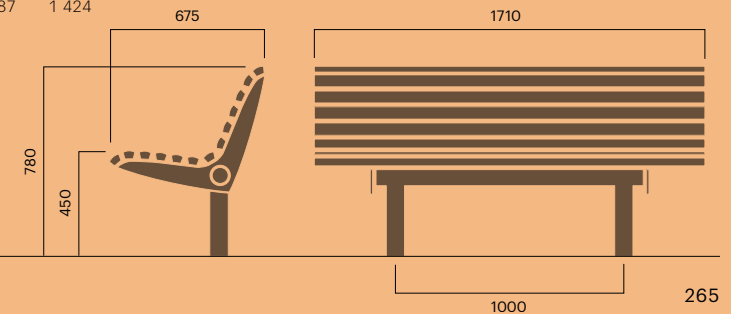

### Urban seat

Free-standing		Kg CO2	MJ
Art. 516-900	1 290 EUR / 1 110 GBP	90	1 625
Art. 516-901	1 170 EUR / 1 010 GBP	90	1 625

Weight: 47 kg

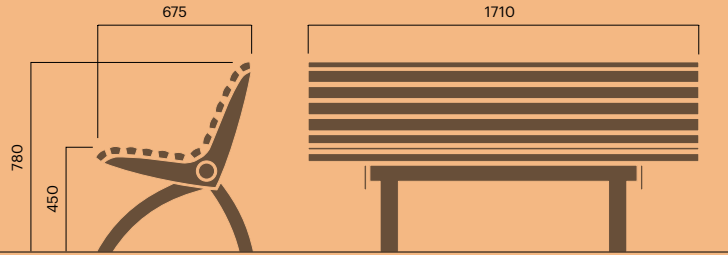

### Urban seat

With granite pedestals		Kg CO2	MJ
Art. 518-900	1 850 EUR / 1 580 GBP	84	1 601
Art. 518-901	1 750 EUR / 1 500 GBP	84	1 601

Weight: 113 kg

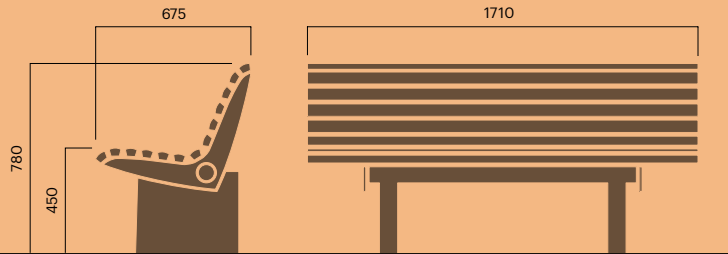

### Urban armrest for seat

Armrest pair		Kg CO2	MJ
Art. 525-900	260 EUR / 225 GBP	19	259
Art. 525-901	220 EUR / 185 GBP	19	259

Weight: 6 kg

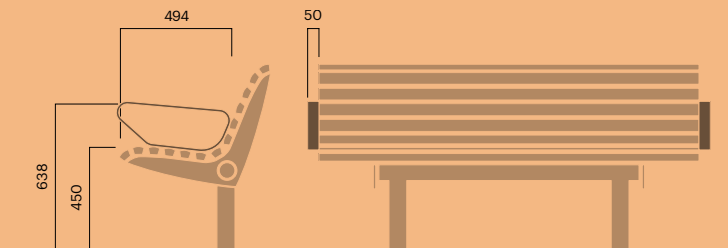

### Urban table

Anchoring A or C		Kg CO2	MJ
Art. 533-900A	940 EUR / 800 GBP	97	1 656
Art. 533-901A	820 EUR / 695 GBP	97	1 656
Art. 533-900C	940 EUR / 800 GBP	96	1 627
Art. 533-901C	820 EUR / 695 GBP	96	1 627

Weight: 45 kg

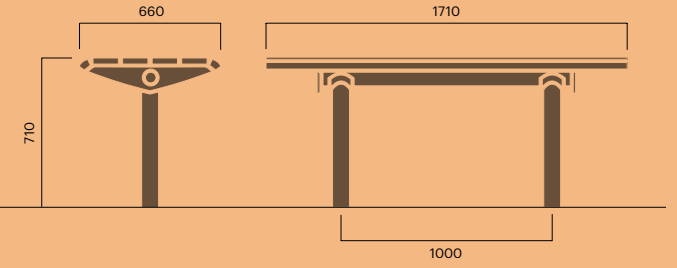

### Urban table

Adapted for wheelchair

Anchoring A or C		Kg CO2	MJ
Art. 539-900A	1 070 EUR / 910 GBP	102	1 772
Art. 539-901A	920 EUR / 790 GBP	102	1 772
Art. 539-900C	1 070 EUR / 910 GBP	97	1 711
Art. 539-901C	920 EUR / 790 GBP	97	1 711

Free-standing		Kg CO2	MJ
Art. 539-900	1 220 EUR / 1 050 GBP	102*	1 772*
Art. 539-901	1 090 EUR / 935 GBP	102*	1 772*

Weight: 48 kg

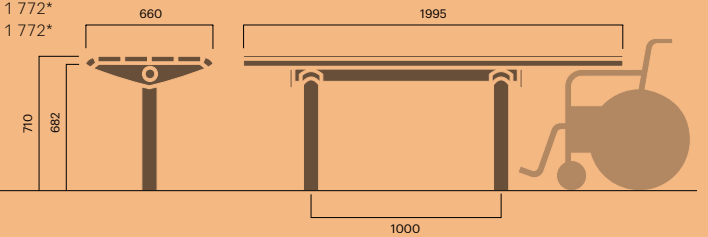

### Urban table

Free-standing		Kg CO2	MJ
Art. 536-900	1 080 EUR / 925 GBP	86	1 498
Art. 536-901	990 EUR / 830 GBP	86	1 498

Weight: 48 kg

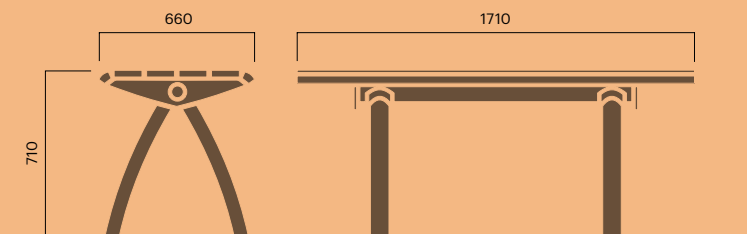

## Urban sun bench

Free-standing / for fixing down		Kg CO2	MJ
Art. 566-900	1 940 EUR / 1 620 GBP	167	2 658
Art. 566-901	1 650 EUR / 1 380 GBP	167	2 658

Weight: 66 kg

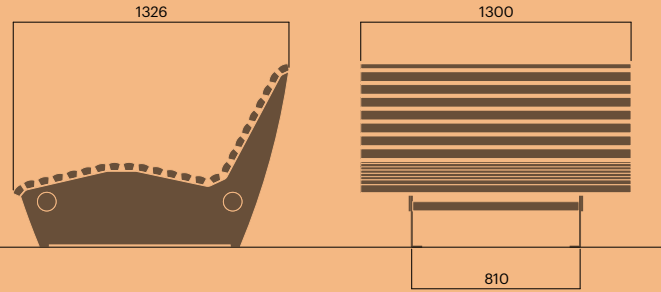

## Urban litter bin

25 litres

For wall or mounting pole		Kg CO2	MJ
Art. 541-900	550 EUR / 470 GBP	38	535
Art. 541-901	480 EUR / 410 GBP	38	535

Weight: 11 kg

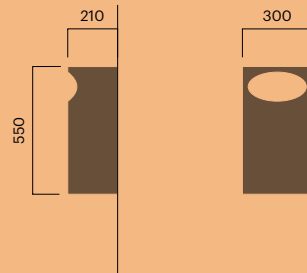

## Urban mounting pole

Anchoring A and C		Kg CO2	MJ
Art. 592-900A	230 EUR / 195 GBP	54	746
Art. 592-901A	210 EUR / 185 GBP	54	746
Art. 593-900C	280 EUR / 235 GBP	54*	746*
Art. 593-901C	220 EUR / 180 GBP	54*	746*

Weight: 16/23 kg

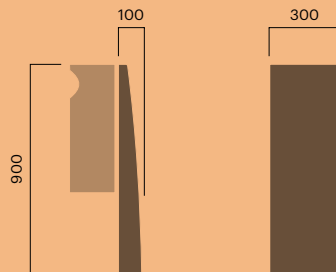

## Urban litter bin

100 litres

		Kg CO2	MJ
Art. 542-900	1 080 EUR / 925 GBP	154	2 240
Art. 542-901	890 EUR / 760 GBP	154	2 240

With ashtray

Art. 543-900	1 190 EUR / 1 010 GBP	160	2 368
Art. 543-901	1 060 EUR / 900 GBP	160	2 368

Weight: 62/63 kg

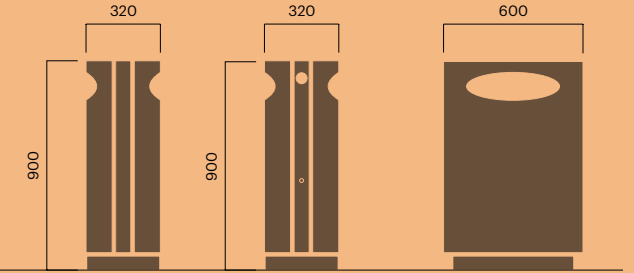

## Urban litter bin

100 litres

Wall-mounted		Kg CO2	MJ
Art. 546-900	890 EUR / 760 GBP	120	1 680
Art. 546-901	770 EUR / 655 GBP	120	1 680

Weight: 38 kg

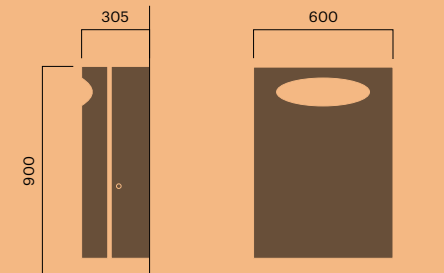

## Urban litter bin

140 litres

		Kg CO2	MJ
Art. 544-900	1 190 EUR / 1 010 GBP	183	2 712
Art. 544-901	1 060 EUR / 900 GBP	183	2 712

With ashtray

Art. 545-900	1 440 EUR / 1 230 GBP	194	2 926
Art. 545-901	1 270 EUR / 1 090 GBP	194	2 926

Recycling 2 x 70 litres

Art. 547-900	1 590 EUR / 1 360 GBP	209	3 067
Art. 547-901	1 430 EUR / 1 220 GBP	209	3 067

Weight: 81/83 kg

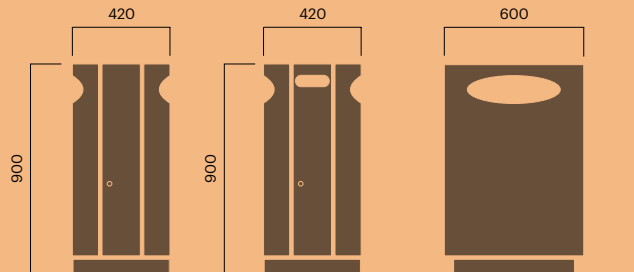



### Urban stainless steel collar

#### For concrete pedestal

100 L		Kg CO2	MJ
Art. 542-002	110 EUR / 90 GBP	8	138

#### For concrete pedestal

140 L		Kg CO2	MJ
Art. 544-002	120 EUR / 105 GBP	8	138

Weight: 2 kg

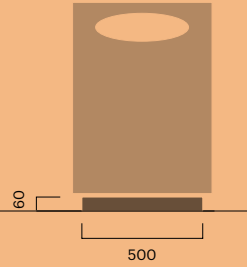

### Urban litter bin

200 litres

		Kg CO2	MJ
Art. 548-900	1 730 EUR / 1 480 GBP	248	3 694
Art. 548-901	1 540 EUR / 1 310 GBP	248	3 694

Weight: 114 kg

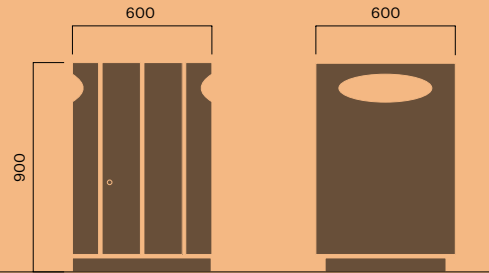

### Urban recycling

3 x 80 litres

		Kg CO2	MJ
Art. 572-900	2 580 EUR / 2 200 GBP	280	3 913
Art. 572-901	2 190 EUR / 1 880 GBP	280	3 913

Weight: 85 kg

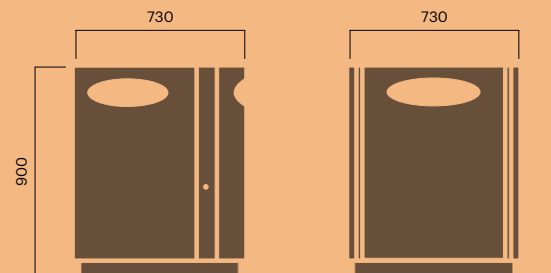

### Urban ashtray

Wall-mounted		Kg CO2	MJ
Art. 560-900	390 EUR / 330 GBP	37	513
Art. 560-901	370 EUR / 310 GBP	37	513

Weight: 8 kg

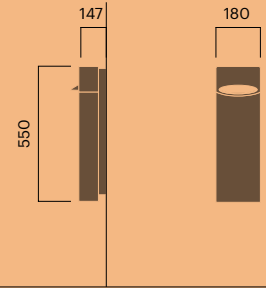

### Urban tree guard

For anchoring		Kg CO2	MJ
Art. 558-900	980 EUR / 840 GBP	148	2 065
Art. 558-901	840 EUR / 720 GBP	148	2 065

Weight: 47 kg

#### Ground fixing set

Art. 559-901	240 EUR / 205 GBP	22	314
--------------	-------------------	----	-----

Weight: 7 kg

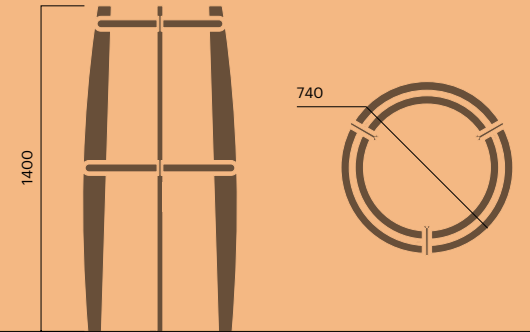

### Urban tree grille

1200 x 1200		Kg CO2	MJ
Art. 565-900	1 180 EUR / 980 GBP	272	3 800
Art. 565-901	960 EUR / 800 GBP	272	3 800

#### D 1380

Art. 565-900R	1 180 EUR / 980 GBP	260	3 623
Art. 565-901R	960 EUR / 800 GBP	260	3 623

Weight: 82/90 kg

Other patterns and sizes available on request

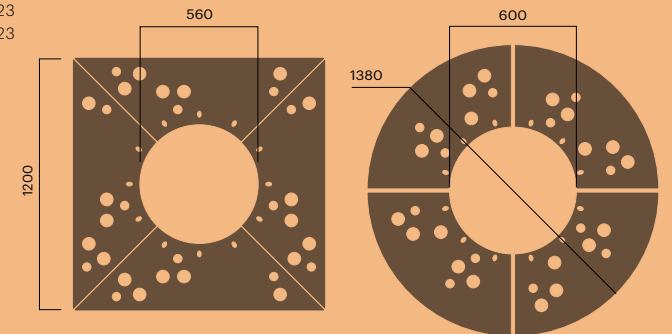

## Urban bollards

### Anchoring options

A: anchoring with base plate

C: concreting in place

D: demountable

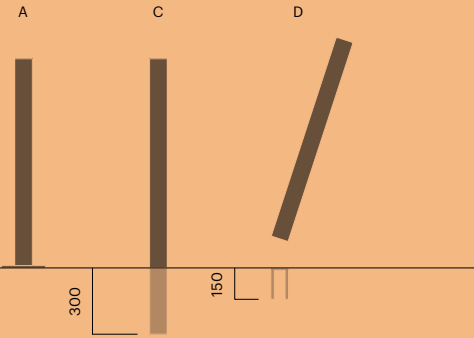

### Urban bollard D 76

Anchoring A or C		Kg CO2	MJ
Art. 585-900A	180 EUR / 155 GBP	27	371
Art. 585-901A	160 EUR / 135 GBP	27	371
Art. 585-900C	160 EUR / 135 GBP	22	305
Art. 585-901C	140 EUR / 125 GBP	22	305

Demountable		Kg CO2	MJ
Art. 585-900D	280 EUR / 235 GBP	28	395
Art. 585-901D	260 EUR / 225 GBP	28	395

Weight: 9/7/9 kg

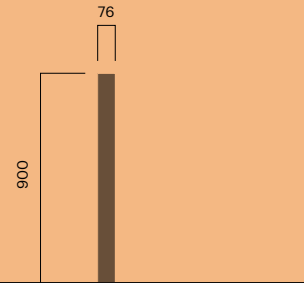

### Urban bollard D 127

Anchoring A or C		Kg CO2	MJ
Art. 588-900A	340 EUR / 285 GBP	60	831
Art. 588-901A	320 EUR / 275 GBP	60	831
Art. 588-900C	330 EUR / 285 GBP	54	747
Art. 588-901C	290 EUR / 245 GBP	54	747

Demountable		Kg CO2	MJ
Art. 588-900D	430 EUR / 370 GBP	60	838
Art. 588-901D	380 EUR / 330 GBP	60	838

Weight: 17/18 kg

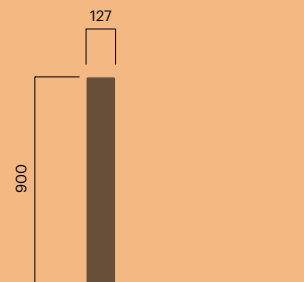

## Urban bollard

### With chain or rope fastener

Anchoring A or C		Kg CO2	MJ
Art. 584-900A	270 EUR / 235 GBP	27	376
Art. 584-901A	250 EUR / 215 GBP	27	376
Art. 584-900C	260 EUR / 225 GBP	29	400
Art. 584-901C	240 EUR / 205 GBP	29	400

Demountable		Kg CO2	MJ
Art. 584-900D	290 EUR / 245 GBP	30	422
Art. 584-901D	270 EUR / 235 GBP	30	422

Weight: 9/10 kg

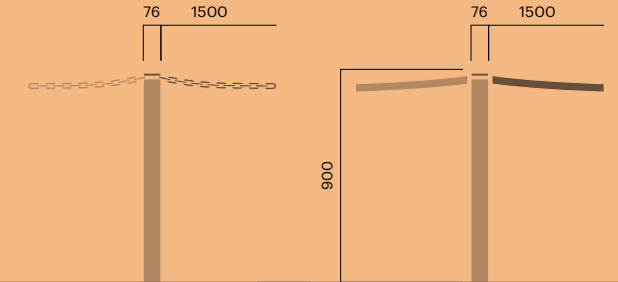

### Urban accessories

		Kg CO2	MJ
Art. 590-900	Chain 1 metre	50 EUR / 45 GBP	6 88
Art. 590-901	Chain 1 metre	30 EUR / 25 GBP	6 88
Art. 582-900	Hemp rope 1.5 metre	210 EUR / 185 GBP	9 186
Art. 582-901	Hemp rope 1.5 metre	200 EUR / 170 GBP	9 186
Art. 574-902	Bird stopper for Urban litter bin	260 EUR / 225 GBP	4 67

### Urban bicycle post

#### For 2 bicycles

Anchoring A or C		Kg CO2	MJ
Art. 586-900A	260 EUR / 225 GBP	34	470
Art. 586-901A	230 EUR / 195 GBP	34	470
Art. 586-900C	230 EUR / 195 GBP	31	437
Art. 586-901C	200 EUR / 170 GBP	31	437

With LED lighting		Kg CO2	MJ
Art. 586-900A-LED	650 EUR / 555 GBP	36	496
Art. 586-901A-LED	590 EUR / 500 GBP	36	496
Art. 586-900C-LED	630 EUR / 545 GBP	34	468
Art. 586-901C-LED	560 EUR / 480 GBP	34	468

Demountable		Kg CO2	MJ
Art. 586-900D	590 EUR / 490 GBP	46	646
Art. 586-901D	540 EUR / 450 GBP	46	646

Weight: 11/10/11 kg

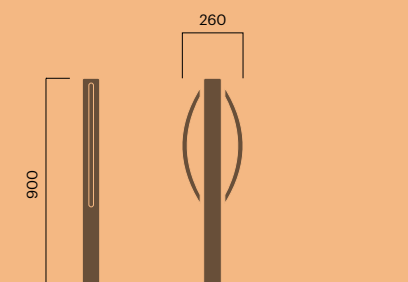

# VEGA

## Vega bicycle post

For 2 bicycles

Powder-coated aluminium		Kg CO2	MJ
Art. 3996-904C	490 EUR / 420 GBP	247	2 502

Weight: 11 kg

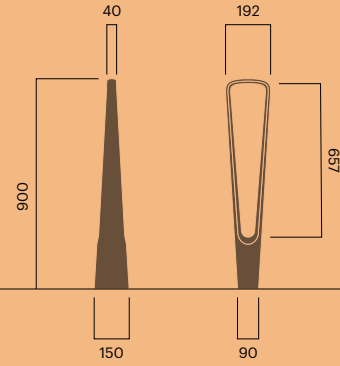

# VIA

## Via complete bench straight

Free-standing or wall mounted (B)		Kg CO2	MJ
Art. 1306-900	1 630 EUR / 1 390 GBP	101	2 096
Art. 1306-901	1 550 EUR / 1 320 GBP	101	2 096
Art. 1306-900B	1 580 EUR / 1 350 GBP	129	2 475
Art. 1306-901B	1 520 EUR / 1 300 GBP	129	2 475

Weight: 85 kg

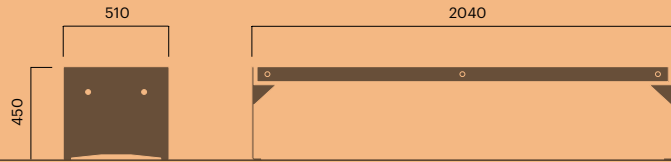

## Via bench top straight

		Kg CO2	MJ
Art. 1320-900	1 120 EUR / 955 GBP	42	1 273
Art. 1320-901	1 080 EUR / 925 GBP	42	1 273

For wall top		Kg CO2	MJ
Art. 1320-900MK	1 060 EUR / 900 GBP	40	1 249
Art. 1320-901MK	1 040 EUR / 890 GBP	40	1 249

Weight: 48/47 kg

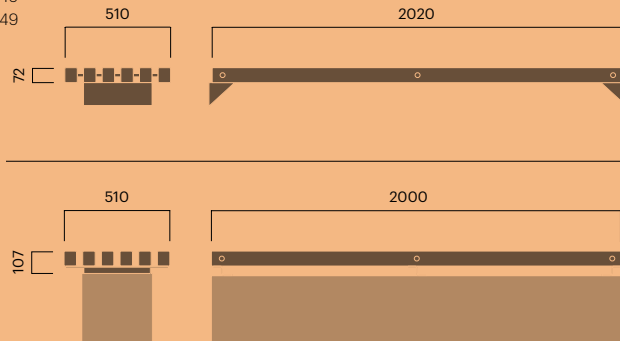

## Via complete bench curved

Free-standing or wall mounted (B)		Kg CO2	MJ
Art. 1308-900	2 370 EUR / 2 030 GBP	217	3 647
Art. 1308-901	2 190 EUR / 1 880 GBP	217	3 647
Art. 1308-900B	2 430 EUR / 2 080 GBP	166	2 929
Art. 1308-901B	2 230 EUR / 1 900 GBP	166	2 929

Weight: 99 kg

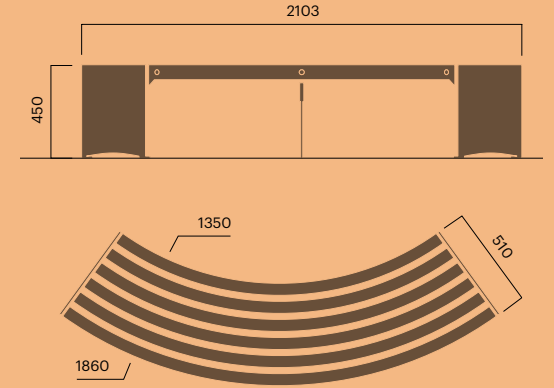

## Via circle bench

		Kg CO2	MJ
Art. 1310-900	9 980 EUR / 8 530 GBP	496	10 009
Art. 1310-901	9 380 EUR / 8 020 GBP	496	10 009

Weight: 404 kg

Other radii on request

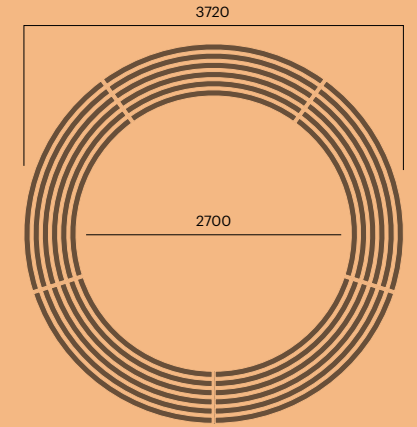

## Via bench top curved

		Kg CO2	MJ
Art. 1330-900	1 870 EUR / 1 600 GBP	99	2 001
Art. 1330-901	1 740 EUR / 1 490 GBP	99	2 001

For wall top		Kg CO2	MJ
Art. 1330-900MK	1 580 EUR / 1 350 GBP	64	1 549
Art. 1330-901MK	1 540 EUR / 1 320 GBP	64	1 549

Weight: 62/46 kg

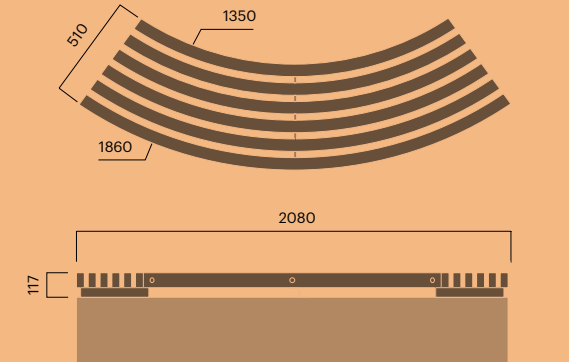

### Via connector

Connector or end piece		Kg CO2	MJ
Art. 1350-900	260 EUR / 220 GBP	59	823
Art. 1350-901	240 EUR / 200 GBP	59	823

Weight: 19/25 kg

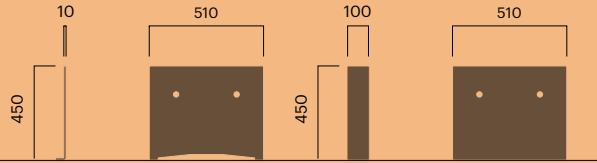

### Via double connector

		Kg CO2	MJ
Art. 1352-900	420 EUR / 360 GBP	136	1 888
Art. 1352-901	380 EUR / 320 GBP	136	1 888

Weight: 35 kg

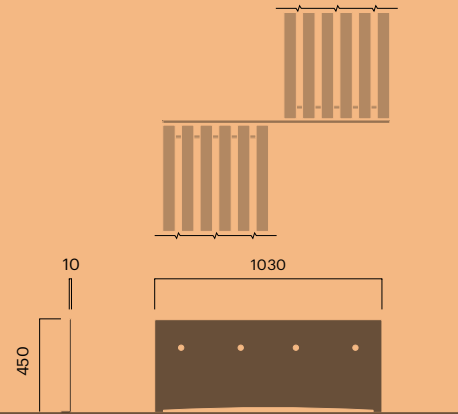

### Via backrest and armrest

Backrest		Kg CO2	MJ
Art. 1327-900	580 EUR / 490 GBP	12	190
Art. 1327-901	530 EUR / 450 GBP	12	190

Weight: 20 kg

Armrest		Kg CO2	MJ
Art. 1325-900	220 EUR / 185 GBP	13	185
Art. 1325-901	190 EUR / 165 GBP	13	185

Weight: 4 kg

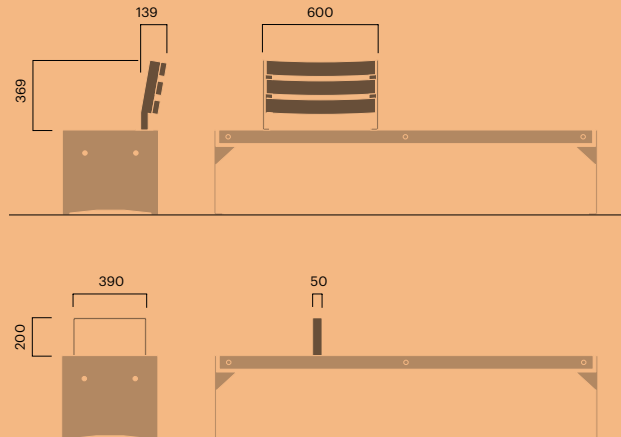

### Via table

		Kg CO2	MJ
Art. 1336-900	2 100 EUR / 1 790 GBP	242	4 286
Art. 1336-901	1 930 EUR / 1 650 GBP	242	4 286

Weight: 126 kg

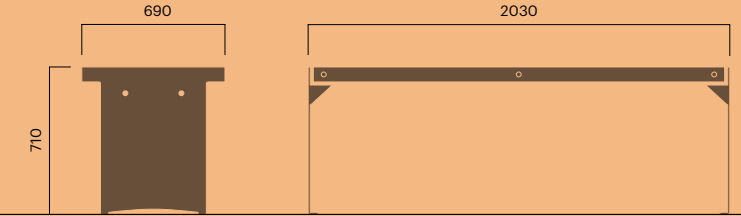

### Via curved table

		Kg CO2	MJ
Art. 1338-900	1 480 EUR / 1 260 GBP	210	3 330
Art. 1338-901	1 360 EUR / 1 160 GBP	210	3 330

Weight: 87 kg

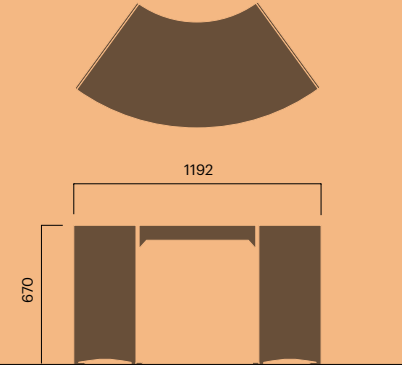

### Via planter

170 litres

Low		Kg CO2	MJ
Art. 1381-900	1 590 EUR / 1 360 GBP	359	4 997
Art. 1381-901	1 390 EUR / 1 190 GBP	359	4 997

350 litres

High		Kg CO2	MJ
Art. 1384-900	2 250 EUR / 1 930 GBP	639	8 892
Art. 1384-901	1 980 EUR / 1 650 GBP	639	8 892

Weight: 114/203 kg

Other sizes available on request

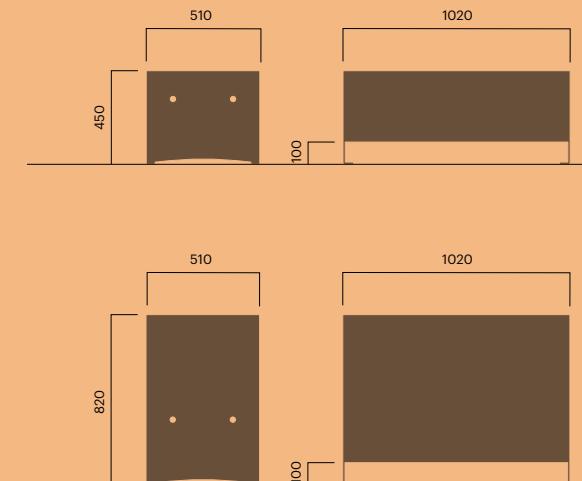

# VROOM

## Vroom bench straight end

		Kg CO2	MJ
Art. 607-900	990 EUR / 850 GBP	148	2 298
Art. 607-901	890 EUR / 800 GBP	148	2 298

Weight: 59 kg

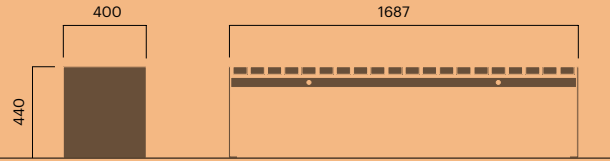

## Vroom seat straight end

		Kg CO2	MJ
Art. 617-900	1 480 EUR / 1 260 GBP	190	2 892
Art. 617-901	1 320 EUR / 1 100 GBP	190	2 892

Weight: 67 kg

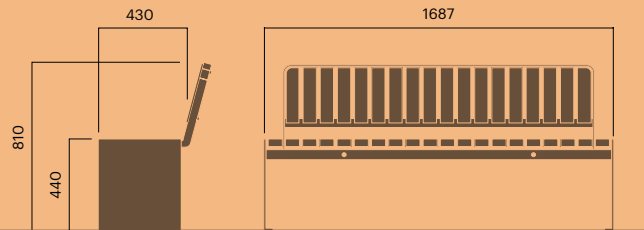

## Vroom bench curved end

		Kg CO2	MJ
Art. 606-900	1 290 EUR / 1 110 GBP	190	2 885
Art. 606-901	1 080 EUR / 925 GBP	190	2 885

Weight: 72 kg

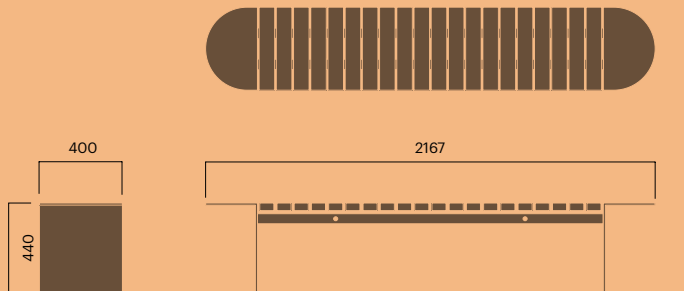

## Vroom seat curved end

		Kg CO2	MJ
Art. 616-900	1 690 EUR / 1 450 GBP	239	3 873
Art. 616-901	1 490 EUR / 1 270 GBP	239	3 873

Weight: 80 kg

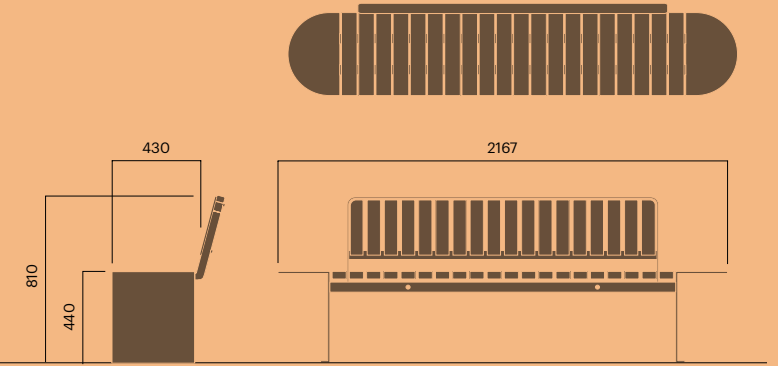

## Vroom 600 bench

		Kg CO2	MJ
Art. 609-900	1 580 EUR / 1 350 GBP	212	3 391
Art. 609-901	1 390 EUR / 1 190 GBP	212	3 391

Weight: 74 kg

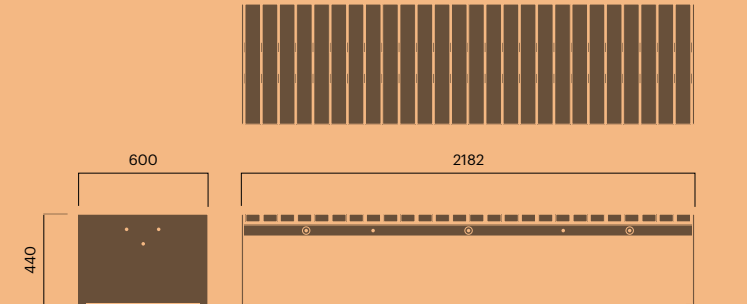

## Vroom 1200 bench

		Kg CO2	MJ
Art. 612-900	2 860 EUR / 2 440 GBP	369	6 022
Art. 612-901	2 560 EUR / 2 180 GBP	369	6 022

Weight: 132 kg

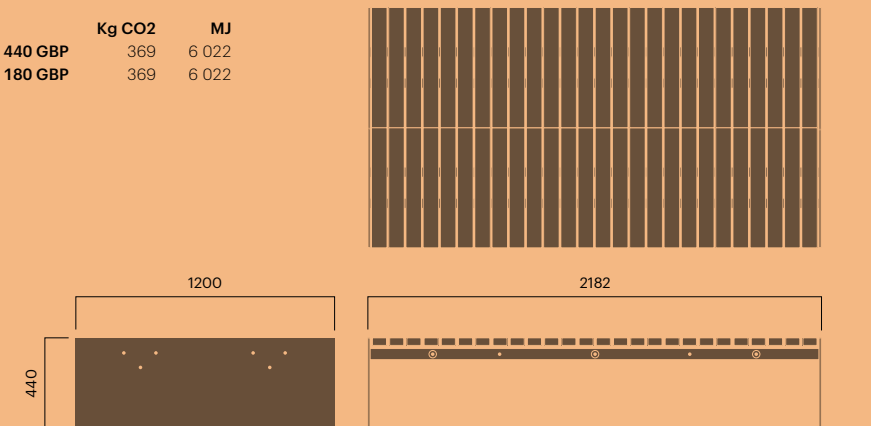

### Vroom bench top

Short		Kg CO2	MJ
Art. 620-900JR	440 EUR / 380 GBP	35	623
Art. 620-901JR	410 EUR / 350 GBP	35	623

Standard		Kg CO2	MJ
Art. 620-900	590 EUR / 500 GBP	54	994
Art. 620-901	540 EUR / 460 GBP	54	994

Long		Kg CO2	MJ
Art. 632-900	990 EUR / 850 GBP	73	1 457
Art. 632-901	920 EUR / 790 GBP	73	1 457

Weight: 18/29/75 kg

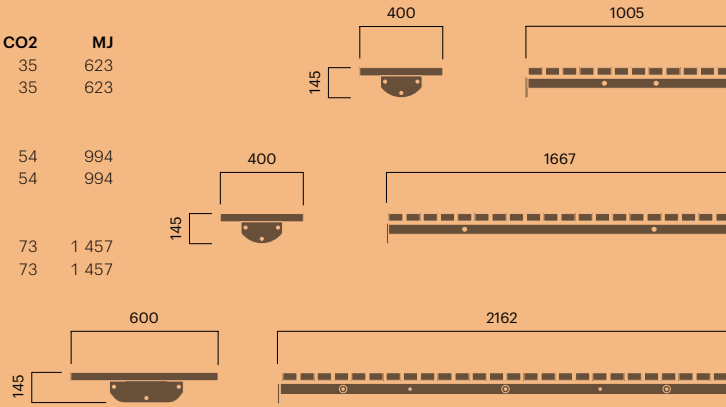

### Vroom backrest for benches of all widths

		Kg CO2	MJ
Art. 629-900	560 EUR / 480 GBP	51	1 010
Art. 629-901	440 EUR / 380 GBP	51	1 010

Weight: 16 kg

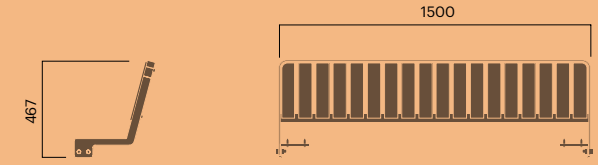

### Vroom bench top for wall top

H87 for wall top		Kg CO2	MJ
Art. 620-900MK	690 EUR / 595 GBP	59	1 066
Art. 620-901MK	650 EUR / 555 GBP	59	1 066

Weight: 31 kg

H55 MKL1 = 988 mm,  
MKL2 = 1667 mm,  
MKL3 = 1984 mm

Art. 620-901MKL1	270 EUR / 235 GBP	18	357
Art. 620-901MKL2	440 EUR / 380 GBP	29	638
Art. 620-901MKL3	540 EUR / 460 GBP	38	806

Other sizes available on request

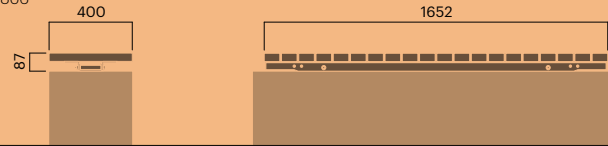

### Vroom circle bench

D2000 (4 bench tops and legs)		Kg CO2	MJ
Art. 610-900-D2	3 580 EUR / 2 980 GBP	373	5 782
Art. 610-901-D2	3 340 EUR / 2 780 GBP	373	5 782

D3000 (6 bench tops and legs)		Kg CO2	MJ
Art. 610-900-D3	5 640 EUR / 4 700 GBP	585	9 018
Art. 610-901-D3	5 220 EUR / 4 350 GBP	585	9 018

D4000 (8 bench tops and legs)		Kg CO2	MJ
Art. 610-900-D4	7 550 EUR / 6 290 GBP	793	12 202
Art. 610-901-D4	6 980 EUR / 5 820 GBP	793	12 202

D5000 (10 bench tops and legs)		Kg CO2	MJ
Art. 610-900-D5	9 770 EUR / 8 140 GBP	1 003	15 511
Art. 610-901-D5	8 980 EUR / 7 480 GBP	1 003	15 511

Weight: 220/330/440/550 kg

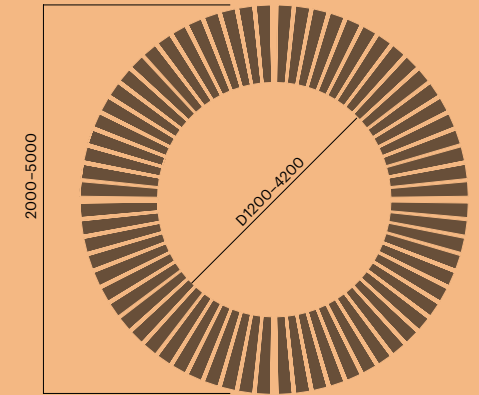

### Vroom armrest

Armrest		Kg CO2	MJ
Art. 624-900	170 EUR / 145 GBP	8	108
Art. 624-901	120 EUR / 105 GBP	8	108

For bench on wall top		Kg CO2	MJ
Art. 624-900MK	170 EUR / 150 GBP	8	108
Art. 624-901MK	120 EUR / 100 GBP	8	108

Weight: 4/5 kg

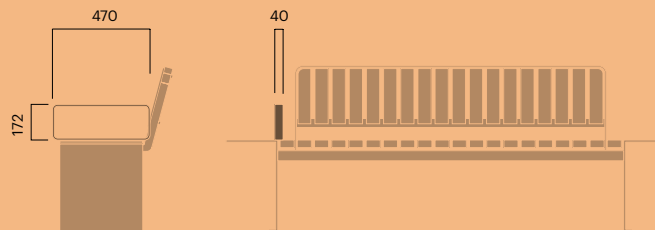

### Vroom bench top curved

D2000		Kg CO2	MJ
Art. 630-900-D2	740 EUR / 620 GBP	47	796
Art. 630-901-D2	690 EUR / 580 GBP	47	796

D3000		Kg CO2	MJ
Art. 630-900-D3	740 EUR / 620 GBP	51	853
Art. 630-901-D3	690 EUR / 595 GBP	51	853

D4000		Kg CO2	MJ
Art. 630-900-D4	740 EUR / 620 GBP	52	871
Art. 630-901-D4	690 EUR / 580 GBP	52	871

D5000		Kg CO2	MJ
Art. 630-900-D5	740 EUR / 620 GBP	54	899
Art. 630-901-D5	690 EUR / 580 GBP	54	899

For wall top		Kg CO2	MJ
Art. 630-900MK	780 EUR / 670 GBP	54*	899*
Art. 630-901MK	690 EUR / 590 GBP	54*	899*
Art. 630-901MKL	590 EUR / 500 GBP	54*	899*

Weight: 22 kg

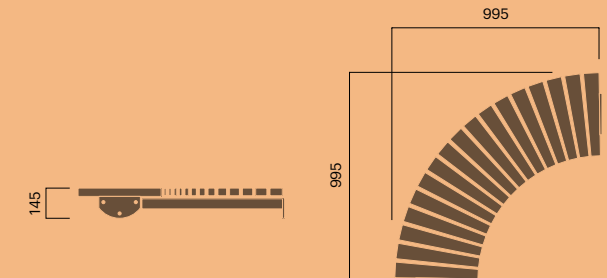

### Vroom curved back internal radius

IR600		Kg CO2	MJ
Art. 622-900-D2	750 EUR / 630 GBP	30	465
Art. 622-901-D2	650 EUR / 540 GBP	30	465
<b>IR1100</b>			
Art. 622-900-D3	750 EUR / 630 GBP	33	505
Art. 622-901-D3	650 EUR / 540 GBP	33	505
<b>IR1600</b>			
Art. 622-900-D4	750 EUR / 630 GBP	35	548
Art. 622-901-D4	650 EUR / 540 GBP	35	548
<b>IR2100</b>			
Art. 622-900-D5	750 EUR / 630 GBP	37	575
Art. 622-901-D5	650 EUR / 540 GBP	37	575

Weight: 11/22 kg

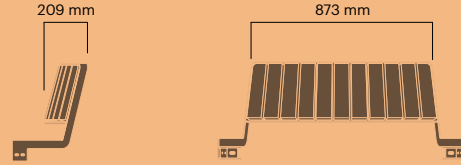

### Vroom curved back external radius

ER1000		Kg CO2	MJ
Art. 623-900-D2	980 EUR / 840 GBP	46	721
Art. 623-901-D2	860 EUR / 740 GBP	46	721
<b>ER1500</b>			
Art. 623-900-D3	980 EUR / 840 GBP	49	912
Art. 623-901-D3	860 EUR / 740 GBP	49	912
<b>ER2000</b>			
Art. 623-900-D4	980 EUR / 840 GBP	44	688
Art. 623-901-D4	860 EUR / 740 GBP	44	688
<b>ER2500</b>			
Art. 623-900-D5	980 EUR / 840 GBP	44	688
Art. 623-901-D5	860 EUR / 740 GBP	44	688

Weight: 33 kg

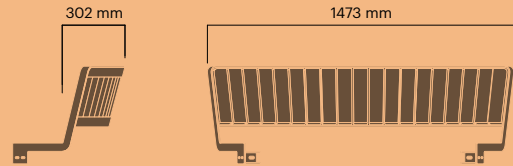

### Vroom coffee table for bench

Bench 400		Kg CO2	MJ
Art. 638-900	330 EUR / 285 GBP	30	416
Art. 638-901	300 EUR / 255 GBP	30	416
<b>Bench 600</b>			
Art. 639-900	330 EUR / 285 GBP	32	444
Art. 639-901	300 EUR / 255 GBP	32	444

Weight: 9 kg

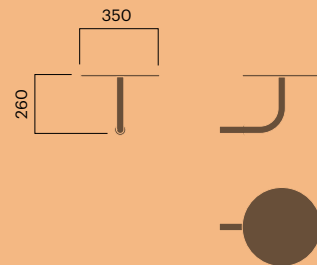

### Vroom narrow table

		Kg CO2	MJ
Art. 635-900	1 340 EUR / 1 150 GBP	214	3 344
Art. 635-901	1 190 EUR / 1 020 GBP	214	3 344

Weight: 78 kg

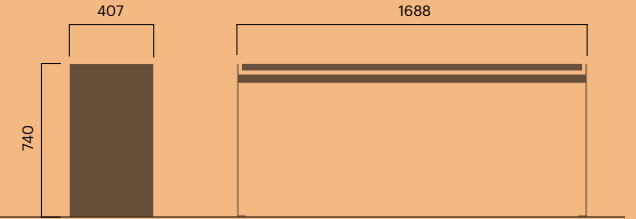

### Vroom table

		Kg CO2	MJ
Art. 636-900	1 460 EUR / 1 250 GBP	215	3 642
Art. 636-901	1 290 EUR / 1 110 GBP	215	3 642

Weight: 105 kg

Add-on module		Kg CO2	MJ
Art. 640-900	1 160 EUR / 995 GBP	136	2 544
Art. 640-901	980 EUR / 840 GBP	136	2 544

Weight: 70 kg

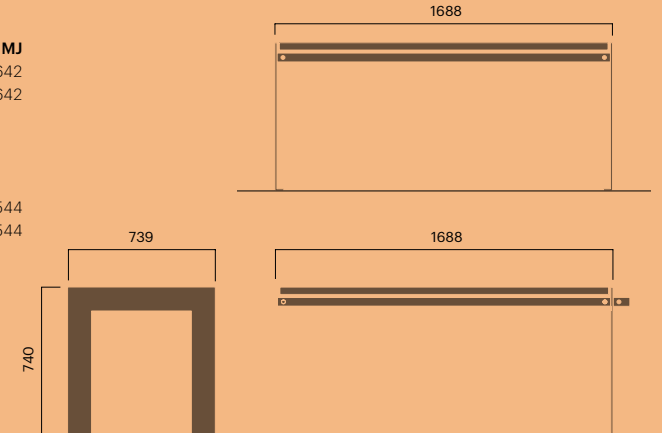

### Vroom square table

		Kg CO2	MJ
Art. 637-900	2 480 EUR / 2 120 GBP	340	5 309
Art. 637-901	2 250 EUR / 1 930 GBP	340	5 309

Weight: 99 kg

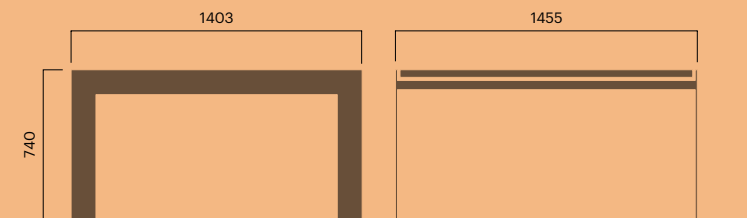

### Vroom leg/connector

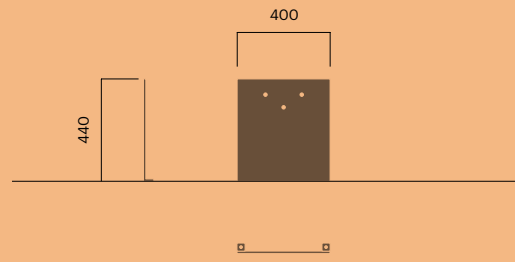

		Kg CO2	MJ
Art. 650-900	210 EUR / 185 GBP	46	641
Art. 650-901	180 EUR / 155 GBP	46	641
Art. 650-900C	250 EUR / 210 GBP	46	641
Art. 650-901C	210 EUR / 185 GBP	46	641

Weight: 15 kg

### Vroom curved end piece

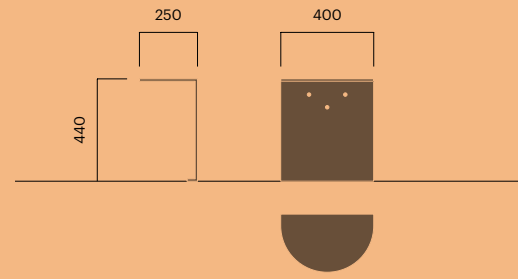

		Kg CO2	MJ
Art. 651-900	360 EUR / 305 GBP	68	941
Art. 651-901	280 EUR / 235 GBP	68	941

Weight: 21 kg

### Vroom 45° angle

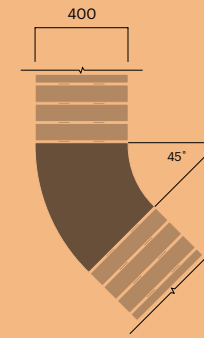

		Kg CO2	MJ
Art. 662-900	640 EUR / 545 GBP	133	1 850
Art. 662-901	580 EUR / 490 GBP	133	1 850

Weight: 42 kg

### Vroom 60° angle

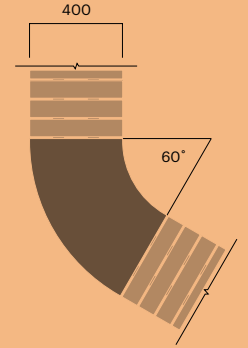

		Kg CO2	MJ
Art. 663-900	660 EUR / 565 GBP	135	1 882
Art. 663-901	590 EUR / 500 GBP	135	1 882

Weight: 40 kg

### Vroom wall mount

Left		Kg CO2	MJ
Art. 658-900V	190 EUR / 165 GBP	35	489
Art. 658-901V	160 EUR / 135 GBP	35	489

Right		Kg CO2	MJ
Art. 658-900H	190 EUR / 165 GBP	35	489
Art. 658-901H	160 EUR / 135 GBP	35	489

Weight: 15/16 kg

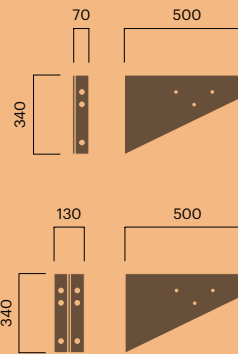

### Vroom 15° angle

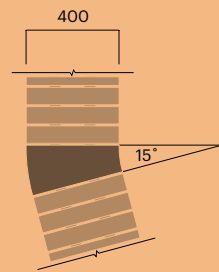

		Kg CO2	MJ
Art. 666-900	590 EUR / 500 GBP	127	1 775
Art. 666-901	490 EUR / 410 GBP	127	1 775

Weight: 30 kg

### Vroom 30° angle

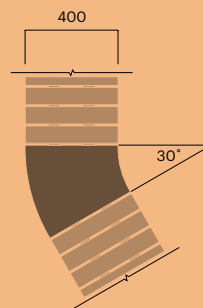

		Kg CO2	MJ
Art. 661-900	610 EUR / 525 GBP	124	1 733
Art. 661-901	530 EUR / 440 GBP	124	1 733

Weight: 38 kg

### Vroom 90° angle

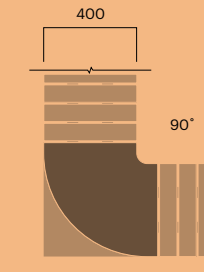

		Kg CO2	MJ
Art. 664-900	680 EUR / 585 GBP	141	1 972
Art. 664-901	610 EUR / 525 GBP	141	1 972

Weight: 45 kg

Corner module available on request

### Vroom 120° angle

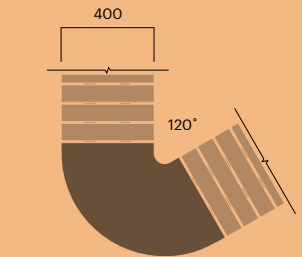

		Kg CO2	MJ
Art. 665-900	720 EUR / 615 GBP	161	2 249
Art. 665-901	640 EUR / 545 GBP	161	2 249

Weight: 47 kg

### Vroom 600 leg/connector

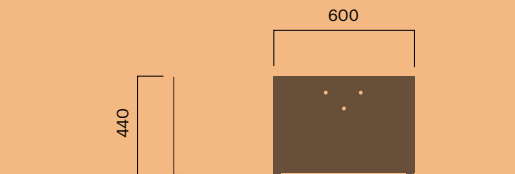

		Kg CO2	MJ
Art. 673-900	290 EUR / 245 GBP	69	960
Art. 673-901	250 EUR / 210 GBP	69	960

Weight: 20 kg

### Vroom 1200 leg/connector

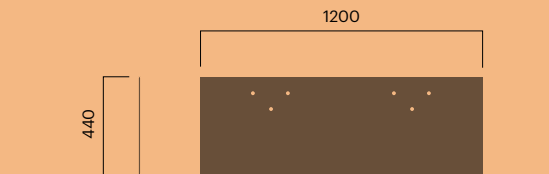

		Kg CO2	MJ
Art. 675-900	450 EUR / 390 GBP	110	1 513
Art. 675-901	360 EUR / 300 GBP	110	1 513

Weight: 32 kg



## Vroom planter – 10 mm steel plate

50 litres

Small		Kg CO2	MJ
Art. 681-900	890 EUR / 760 GBP	204	2 848
Art. 681-901	760 EUR / 645 GBP	204	2 848

Weight: 64 kg

230 litres

Large		Kg CO2	MJ
Art. 684-900	1 890 EUR / 1 620 GBP	533	7 428
Art. 684-901	1 740 EUR / 1 490 GBP	533	7 428

Weight: 169 kg

Other sizes on request

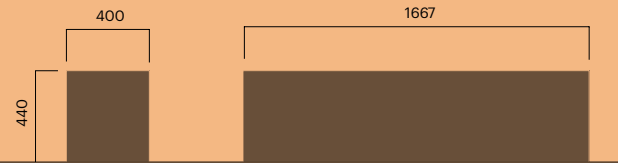
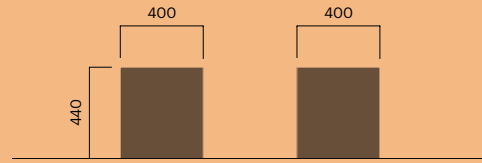

## Vroom litter bin

80 litres

		Kg CO2	MJ
Art. 642-900	1 590 EUR / 1 360 GBP	295	4 106
Art. 642-901	1 340 EUR / 1 150 GBP	295	4 106

Corrugated front and back

Art. 642-900R	1 650 EUR / 1 420 GBP	285	3 982
Art. 642-901R	1 390 EUR / 1 190 GBP	285	3 982

Weight: 82/79 kg

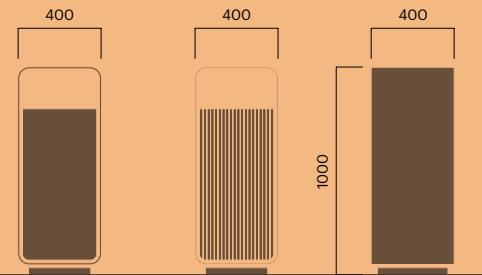

## Vroom litter bin

140 litres

		Kg CO2	MJ
Art. 644-900	1 730 EUR / 1 480 GBP	285	3 982
Art. 644-901	1 580 EUR / 1 350 GBP	285	3 982

Corrugated front and back

Art. 644-900R	1 820 EUR / 1 560 GBP	396	5 514
Art. 644-901R	1 640 EUR / 1 400 GBP	396	5 514

Weight: 108 kg

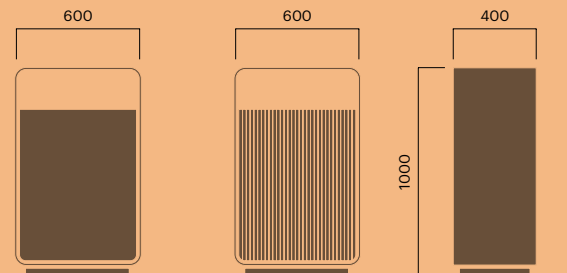

## Vroom bicycle rack

For 2 bicycles

Small, powder-coated aluminium		Kg CO2	MJ
Art. 686-904A	220 EUR / 185 GBP	19	319
Art. 686-904C	180 EUR / 155 GBP	21	361

Large, powder-coated aluminium

Art. 696-904A	350 EUR / 295 GBP	30	503
Art. 696-904C	190 EUR / 165 GBP	25	418

Weight: 8/10 kg

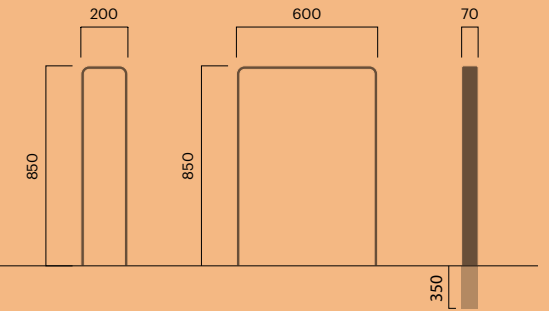

## Vroom bicycle rack

Free-standing rack for 8 bicycles

		Kg CO2	MJ
Art. 688-900	1 670 EUR / 1 420 GBP	250	3 695

Weight: 95 kg

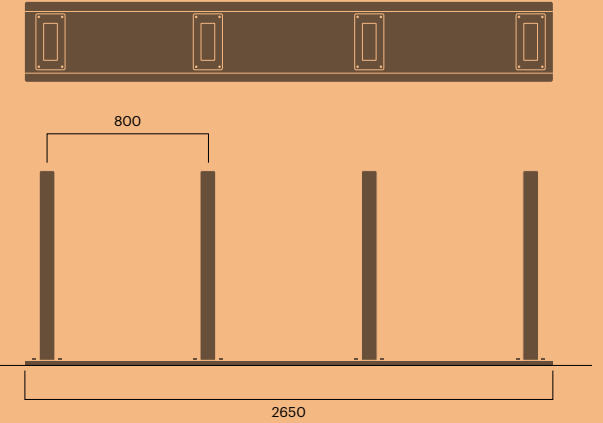

## OPTIONAL EXTRAS

USB power outlet (double)

Universal model for benches		Kg CO2	MJ
Art. 90004-902	520 EUR / 440 GBP	9	130

LED lighting strip

Art. LEDR 2700K 1200mm	420 EUR / 360 GBP
------------------------	-------------------

Weight: 1.2 kg



# We are here for you

## Oslo

Vestre AS  
Drammensveien 44A  
0271 Oslo  
+47 23 00 78 40  
Norway  
post@vestre.com

## Magnor

The Plus  
Gaustadvegen 140  
2240 Magnor  
Norway

## Torsby

Vestre AB  
Bergebyvägen 27  
685 34 Torsby  
Sweden  
+46 (0)560 688877  
info@vestre.com

## London

Vestre Ltd.  
26 Store Street  
London, WC1E 7BT  
United Kingdom  
+44 (0)207 846 8725  
uk@vestre.com

## Berlin

Vestre GmbH  
Oranienburger Str. 27  
10117 Berlin  
Germany  
+49 (0)30 407 417 95  
de@vestre.com

## Paris

Pro Urba  
51 rue Louis Ampère  
ZI des Chanoux  
93330 Neuilly-sur-Marne  
France  
+33 (0)1 58 03 00 38  
prourba@prourba.com

## Geneva

Pro Urba  
Route de Jussy 35  
1226 Thônex  
Switzerland  
+41 (0)22 849 05 27  
+41 (0)78 630 82 62  
contact@prourba.ch

## New York

Vestre Inc.  
1740 Broadway, 15th Floor  
New York, NY 10019  
USA  
+1 212 634 9658  
usa@vestre.com

## Los Angeles

Vestre Inc.  
663 San Juan Avenue  
Los Angeles, CA 90291  
USA  
+1 310 728 4025  
usa@vestre.com

vestre.com

vestrehabitats.no  
theplus.no

Vestre, VestreQualityProgramme™,  
Vestre Habitats, The Plus and  
Vestre's products are trademarked.

*Good design shouldn't be reserved for a small group of people who have the money to pay for it. By furnishing public places, Vestre makes good design accessible to everyone.*

Design: Tank

Photos: Matteo Gastel, Nicolas Tourenc, Einar Aslaksen, Eric Einwiller, Lars Tornøe, Adam Stirling, Max Rommel, Allan Hagerup, Vincenzo Floramo, Calle Huth, ArchiCGI

Printing: RK Grafisk, Oslo, Norway

The paper is environmentally certified according to the Forest Stewardship Council FSC® (FSC-C020637) and PEFC™ (PEFC/05-33-99).

The printing house has had a Nordic Swan Ecolabel since 2005 (licence number 241 450) and is FSC certified (licence number FSC-C116731).



© Vestre 2022

In this year's inspiration book, Vestre encourages people to find their way back – to each other and to nature – so that we can ensure that our planet continues to be habitable for future generations. One way is to create sociable meeting places where people can come together and create a common 'we'. Another way is to be uncompromising when it comes to the way we do business. Between the covers of this book, you will get to read more about just that. You will also find practical information about our furniture, such as the purpose, price list and carbon footprint for each individual product. This makes it easier to compare your different options.