

Preisliste & technische Informationen

The logo for the brand 'vestre' is located in the bottom right corner of the page. It consists of the word 'vestre' in a lowercase, bold, sans-serif font, centered within a thin black rectangular border.

vestre

Alle Preise (Stand 05/24) verstehen sich netto zzgl. der gesetzlichen Mehrwertsteuer und beziehen sich auf Standardmodelle. Soweit nicht anderweitig beschrieben, wird das gesamte Mobiliar aus skandinavischem Kiefernholz (imprägniert mit Leinöl) hergestellt. Druckfehler und Preisänderungen sind vorbehalten. Aktuelle Preise finden Sie unter vestre.com.

Eine verbindliche Bestellung liegt erst dann vor, wenn die Bestellung bestätigt worden ist.

Nomenklatur:

XXX-901: Das Produkt besteht aus schwedischem Stahl gem. DIN EN 10 025, feuerverzinkt nach ISO 1461. Die Oberfläche erhält mit der Zeit eine matt-graue Patina und ist dauerhaft vor Rost geschützt.

XXX-900: Das Produkt besteht aus schwedischem Stahl gem. DIN EN 10 025, feuerverzinkt nach ISO 1461, anschließend nach Korrosionsklasse C5-M pulverbeschichtet in RAL-Wahlfarbe.

XXX-902: Das Produkt besteht aus Edelstahl.

XXX-904: Das Produkt besteht aus Circal Aluminium mit >75% Recyclinganteil und wird in RAL-Wahlfarbe pulverbeschichtet

XXX-XXXA: Verankerung durch aufschrauben auf Untergrund mithilfe von Laschen oder Fußplatte.

XXX-XXXB: Geeignet für Mauerbefestigung.

XXX-XXXC: Verankerung durch Einbau unter Flur.

XXX-XXXD: Demontierbar

XXX-XXXMK: Geeignet als Maueraufsatz

XXX-XXXP: Auflage-, und/ oder Sitzflächen bestehen aus perforiertem Stahl.

XXX-XXXS: Stuhl / Barhocker ist drehbar.

XXX-XXXK: Übergangsmodul.

Kg CO2: Der CO2-Fußabdruck des Produkts in kg (A1 - A3, vom Rohmaterial zum fertigen Produkt).

MJ: Gesamtenergie, die beim Herstellungsprozess (A1 - A3) des Produktes benötigt wird

Es wurden Angaben eines vergleichbaren Produktes verwendet.

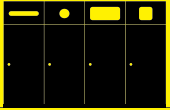

Acceptor 8



Air 11



April 11

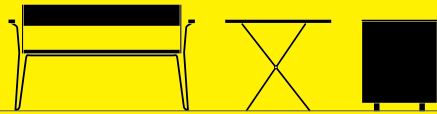

April GO 22



Atlas 26



Berg 28



Berlin 29



Bloc 30



Boboli 43



Bøy 45



Briskeby 46

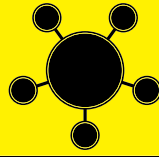

Buzz 47

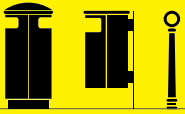

City 48



Coast 53



Code 53



Corner 54

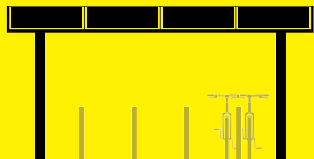

Cover 55



Cycle 55



Dialog 55



Edo 57



Folk 58



Forum 60



Hill 63



Hvilan 63

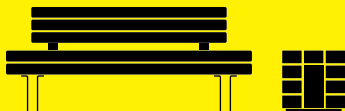

Kong 66



Kyoto 67



Move 68

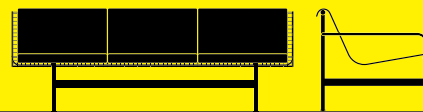

Munch 69

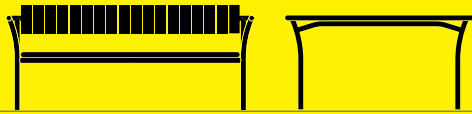

Parc 72

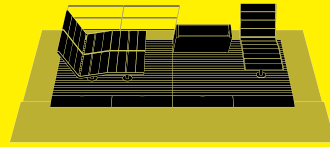

Parklets 2.0 73



Plinth 77

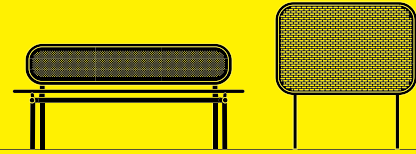

Pop 79



Porto 82



Reale 85



Sinus 87



Stones 88



Stoop 89



Stripes 90



Tour 93

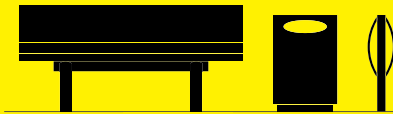

Urban 94



Vega 103

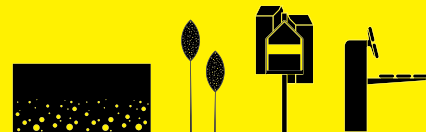

Vestre Habitats 104



Via 107



Vroom 111



Ypsilon 122



Zusatzgeräte 125

Acceptor



Acceptor 110 Mülltrennsystem

2 x 55 Liter		kg CO ₂ e	MJ	kg
Art. 2142-900	1 690 EUR	275	3 838	87
Art. 2142-901	1 430 EUR	275	3 838	87

1 x 110 Liter		kg CO ₂ e	MJ	kg
Art. 2144-900	1 690 EUR	278	3 875	88
Art. 2144-901	1 430 EUR	278	3 875	88

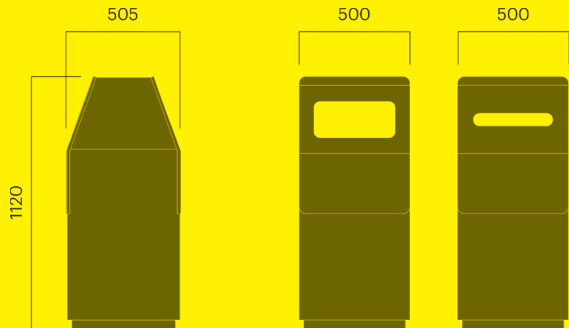

Acceptor 110 Mülltrennsystem

3 x 110 Liter		kg CO ₂ e	MJ	kg
Art. 2192-900	3 690 EUR	739	10 746	173
Art. 2192-901	3 190 EUR	739	10 746	173

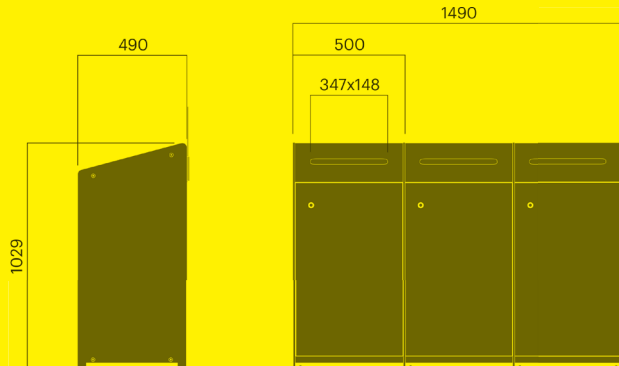

Acceptor 160 Mülltrennsystem

2 x 160 Liter		kg CO ₂ e	MJ	kg
Art. 2145-900	3 050 EUR	486	6 779	155
Art. 2145-901	2 510 EUR	486	6 779	155

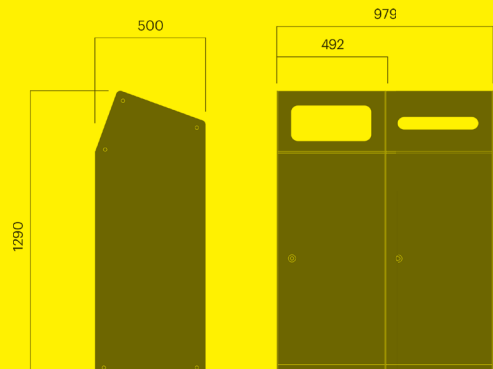

Acceptor 160 Mülltrennsystem

3 x 160 Liter		kg CO ₂ e	MJ	kg
Art. 2146-900	4 550 EUR	679	9 473	219
Art. 2146-901	3 830 EUR	679	9 473	219

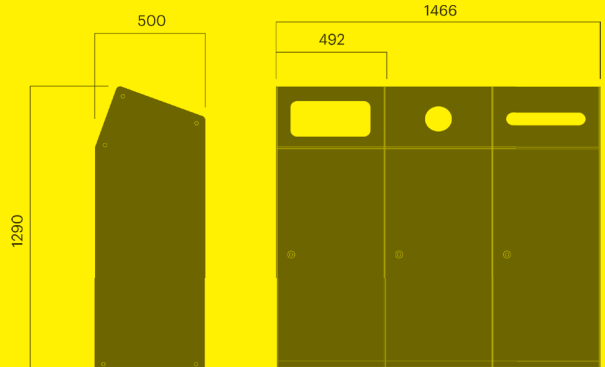

Acceptor 160 Mülltrennsystem

4 x 160 Liter		kg CO ₂ e	MJ	kg
Art. 2147-900	5 860 EUR	722	10 481	284
Art. 2147-901	5 110 EUR	722	10 481	284

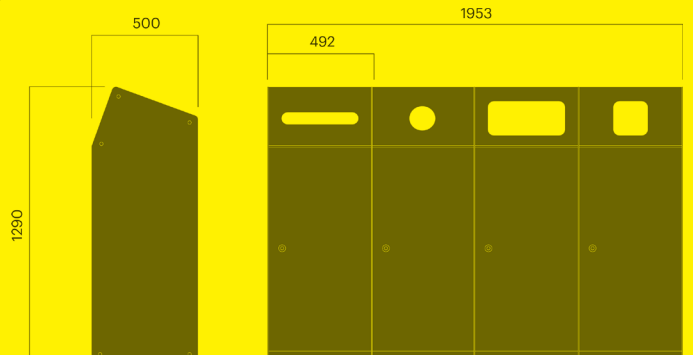

Acceptor Einwurföffnung

Wählen Sie zwischen verschiedenen Öffnungen für den Acceptor 160

Gewicht: 8 kg

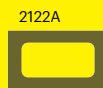

kg CO₂: 22
MJ: 305



kg CO₂: 24
MJ: 328



kg CO₂: 24
MJ: 333



kg CO₂: 22
MJ: 305



Air Hockerbank

freistehend		kg CO ₂ e	MJ	kg
Art. 3206-900	1170 EUR	79	1536	31
Art. 3206-901	950 EUR	79	1536	31



Air Bank

freistehend		kg CO ₂ e	MJ	kg
Art. 3217-900	2120 EUR	171	2740	71
Art. 3217-901	1950 EUR	171	2740	71

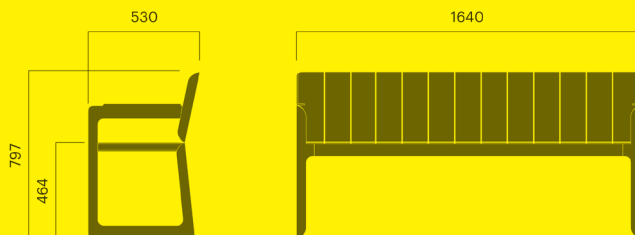

Air Tisch

freistehend		kg CO ₂ e	MJ	kg
Art. 3236-900	1580 EUR	116	1901	51
Art. 3236-901	1290 EUR	116	1901	51

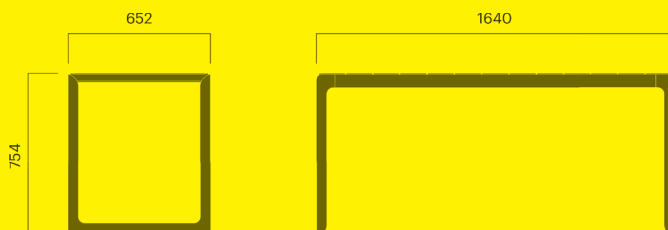



Verankerungsmöglichkeiten

- A: Fußplatte
- B: Wandbefestigung
- C: Einbau unter Flur
- MK: Mauerbefestigung

S: Drehbarer Stuhl, siehe technische Informationen

(+150 EUR)

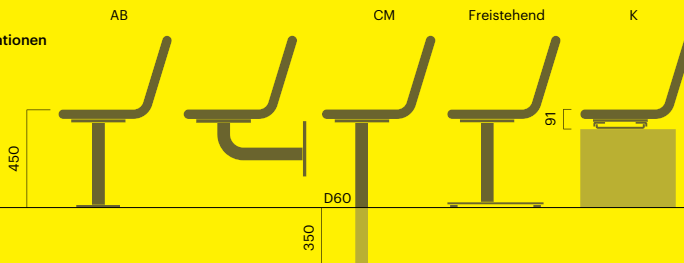

April Armlehne

April Bänke und Stühle sind mit drei verschiedenen Armlehnen erhältlich.

Standard-Armlehne

Armlehne aus Holz
Z.B. XXX-XXXWO

Universelle Armlehne
(Universelle Ausführung)
Z.B. XXX-XXX T

110 EUR
Gewicht: 1 kg

kg CO₂: 1
MJ: 30

Armlehne i tre

Universelt armlene



April perforiert

April Bänke, Stühle und Tische sind auch erhältlich mit Rücken, Sitzen und Tischplatten aus perforiertem Stahl.

Z.B. XXX-XXX P

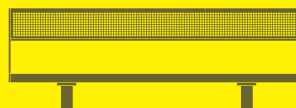
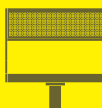
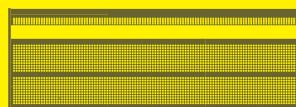
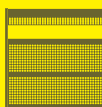

April Hocker

Verankerung A, B, C oder MK		kg CO ₂ e	MJ	kg
Art. 70-900A	420 EUR	38	584	15
Art. 70-901A	370 EUR	38	584	15
Art. 70-900B	510 EUR	38	589	16
Art. 70-901B	470 EUR	38	589	16
Art. 70-900C	410 EUR	38	594	15
Art. 70-901C	360 EUR	38	594	15
Art. 70-900MK	420 EUR	26	420	11
Art. 70-901MK	360 EUR	26	420	11
freistehend				
Art. 71-900	630 EUR	57	851	18
Art. 71-901	520 EUR	57	851	18

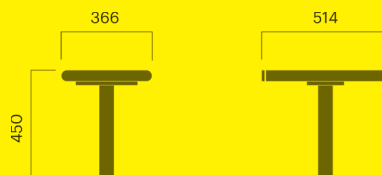

April Stuhl

Verankerung A, B, C oder MK		kg CO ₂ e	MJ	kg
Art. 74-900A	550 EUR	50	790	20
Art. 74-901A	470 EUR	50	790	20
Art. 74-900B	630 EUR	50	790	21
Art. 74-901B	560 EUR	50	790	21
Art. 74-900C	520 EUR	51	801	21
Art. 74-901C	450 EUR	51	801	21
Art. 74-900MK	510 EUR	39	631	17
Art. 74-901MK	450 EUR	39	631	17

freistehend

Art. 75-900	740 EUR	69	1 055	27
Art. 75-901	650 EUR	69	1 055	27

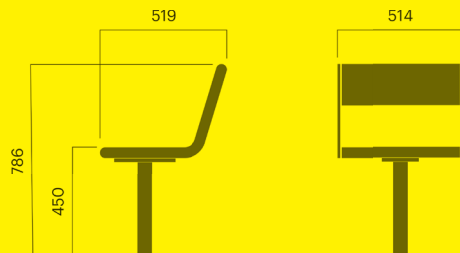

April Stuhl

mit Armlehnen, Verankerung A, B, C oder MK		kg CO ₂ e	MJ	kg
Art. 76-900AT	610 EUR	69	1 055	27
Art. 76-901AT	520 EUR	69	1 055	27
Art. 76-900BT	710 EUR	69	1 057	27
Art. 76-901BT	600 EUR	69	1 057	27
Art. 76-900CT	590 EUR	70	1 069	27
Art. 76-901CT	510 EUR	70	1 069	27
Art. 76-900MK	590 EUR	45	725	19
Art. 76-901MK	500 EUR	45	725	19

mit Armlehnen, freistehend

Art. 77-900T	820 EUR	76	1 154	33
Art. 77-901T	710 EUR	76	1 154	33

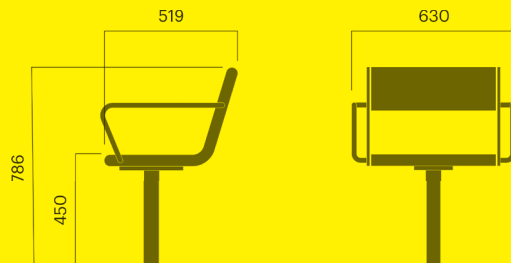

April Stuhl, hoher Rücken

ohne Armlehnen, Verankerung A oder C		kg CO ₂ e	MJ	kg
Art. 763-900A	930 EUR	71	1 244	35
Art. 763-901A	830 EUR	71	1 244	35
Art. 763-900C	910 EUR	73	1 267	36
Art. 763-901C	810 EUR	73	1 267	36

mit Armlehnen, Verankerung A oder C

Art. 764-900AT	1 160 EUR	91	1 520	41
Art. 764-901AT	1 050 EUR	91	1 520	41
Art. 764-900CT	1 130 EUR	93	1 544	42
Art. 764-901CT	1 030 EUR	93	1 544	42

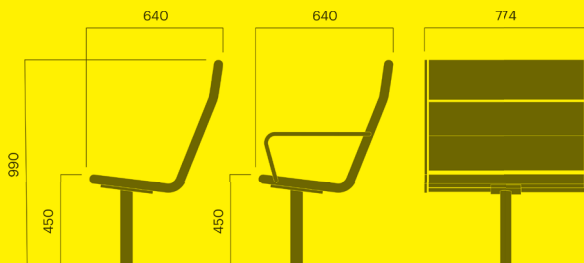

April Barstuhl

Verankerung A oder C		kg CO ₂ e	MJ	kg
Art. 78-900A	810 EUR	70	1 085	28
Art. 78-901A	760 EUR	70	1 085	46
Art. 78-900C	790 EUR	71	1 100	27
Art. 78-901C	740 EUR	71	1 100	27

freistehend

Art. 78-900	1 170 EUR	129	1 902	42
Art. 78-901	1 090 EUR	129	1 902	46

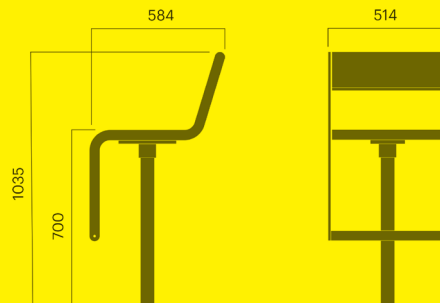

April Barstuhl

mit Armlehnen, Verankerung A oder C		kg CO ₂ e	MJ	kg
Art. 79-900A	970 EUR	38	584	26
Art. 79-901A	850 EUR	38	584	27
Art. 79-900C	950 EUR	38	594	27
Art. 79-901C	820 EUR	38	594	27

mit Armlehnen, freistehend

Art. 79-900	1 260 EUR	125	1 845	44
Art. 79-901	1 130 EUR	125	1 845	44

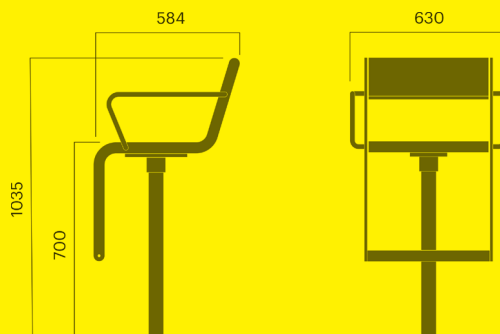

April Hockerbank

Verankerung A, B, C oder MK		kg CO ₂ e	MJ	kg
Art. 703-900A	720 EUR	67	1 134	31
Art. 703-901A	610 EUR	67	1 134	31
Art. 703-900B	810 EUR	70	1 170	32
Art. 703-901B	710 EUR	70	1 170	32
Art. 703-900C	670 EUR	69	1 162	32
Art. 703-901C	570 EUR	69	1 162	32
Art. 703-900MK	630 EUR	44	810	24
Art. 703-901MK	550 EUR	44	810	24

freistehend

Art. 706-900	830 EUR	76	1 260	34
Art. 706-901	730 EUR	76	1 260	34

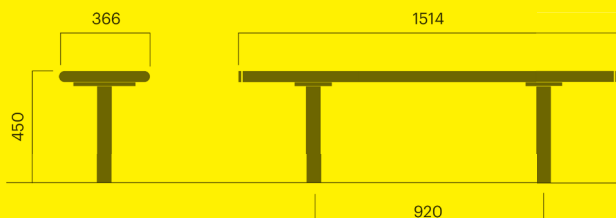

April Hockerbank

mit Armlehnen		kg CO ₂ e	MJ	kg
Verankerung A, B, C oder MK				
Art. 704-900A	1 050 EUR	77	1 265	34
Art. 704-901A	900 EUR	77	1 265	34
Art. 704-900B	1 170 EUR	79	1 303	35
Art. 704-901B	1 040 EUR	79	1 303	35
Art. 704-900C	1 010 EUR	77	1 265	35
Art. 704-901C	860 EUR	77	1 265	35
Art. 704-900MK	1 020 EUR	53	941	27
Art. 704-901MK	870 EUR	53	941	34
mit Armlehnen, freistehend				
Art. 707-900	1 170 EUR	86	1 396	37
Art. 707-901	1 060 EUR	86	1 396	37

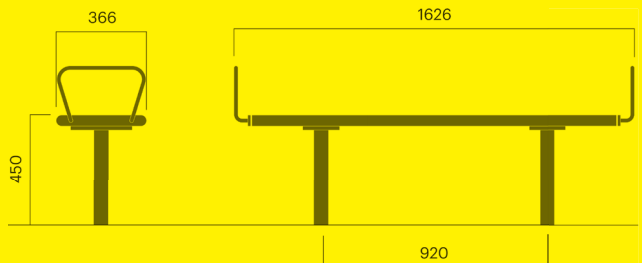

April Bank

Verankerung A, B, C oder MK		kg CO ₂ e	MJ	kg
Art. 713-900A	840 EUR	83	1 446	41
Art. 713-901A	740 EUR	83	1 446	41
Art. 713-900B	990 EUR	83	1 456	41
Art. 713-901B	870 EUR	83	1 456	41
Art. 713-900C	790 EUR	84	1 470	42
Art. 713-901C	690 EUR	84	1 470	42
Art. 713-900MK	820 EUR	51	799	34
Art. 713-901MK	680 EUR	51	799	34
freistehend				
Art. 716-900	980 EUR	96	1 629	45
Art. 716-901	850 EUR	96	1 629	45

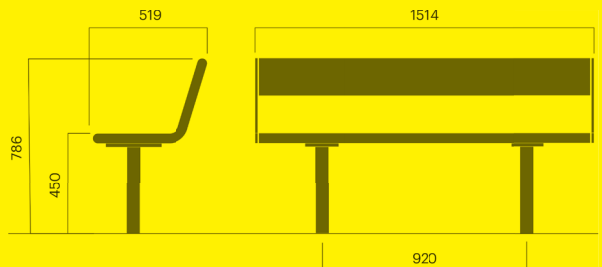

April Bank

mit Armlehnen, Verankerung A, B, C oder MK		kg CO ₂ e	MJ	kg
Art. 714-900A	980 EUR	89	1 535	43
Art. 714-901A	830 EUR	89	1 535	43
Art. 714-900B	1 090 EUR	106	1 774	43
Art. 714-901B	920 EUR	106	1 774	43
Art. 714-900C	940 EUR	91	1 559	44
Art. 714-901C	790 EUR	91	1 559	44
Art. 714-900MK	890 EUR	59	1 118	36
Art. 714-901MK	740 EUR	59	1 118	36
mit Armlehnen, freistehend				
Art. 717-900	1 050 EUR	102	1 719	47
Art. 717-901	920 EUR	102	1 719	47

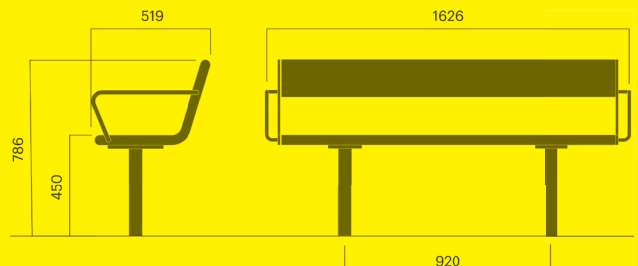

April Liegebank

Verankerung A oder C		kg CO ₂ e	MJ	kg
Art. 766-900A	1 670 EUR	149	2 588	72
Art. 766-901A	1 490 EUR	145	2 546	72
Art. 766-900C	1 630 EUR	149	2 588	73
Art. 766-901C	1 440 EUR	145	2 546	73

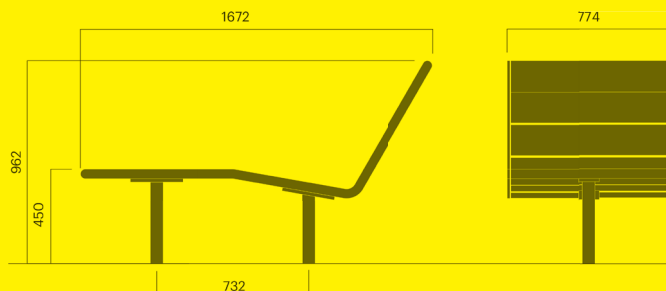

April Bank, hoher Rücken

Verankerung A oder C		kg CO ₂ e	MJ	kg
Art. 768-900A	1 410 EUR	101	1 898	55
Art. 768-901A	1 260 EUR	101	1 898	56
Art. 768-900C	1 370 EUR	102	1 903	57
Art. 768-901C	1 220 EUR	102	1 903	57

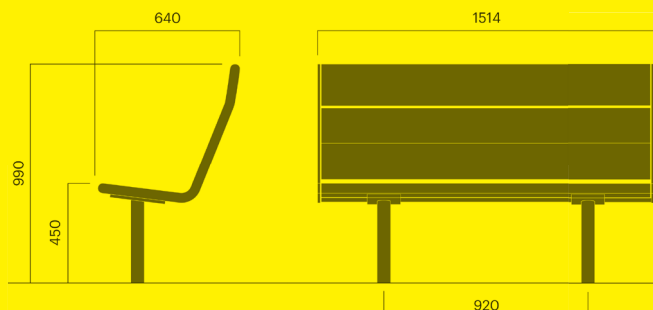

April Bank, hoher Rücken

mit Armlehnen, Verankerung A oder C		kg CO ₂ e	MJ	kg
Art. 769-900AT	1 700 EUR	118	2 128	62
Art. 769-901AT	1 490 EUR	118	2 128	62
Art. 769-900CT	1 660 EUR	121	2 180	63
Art. 769-901CT	1 440 EUR	121	2 180	63

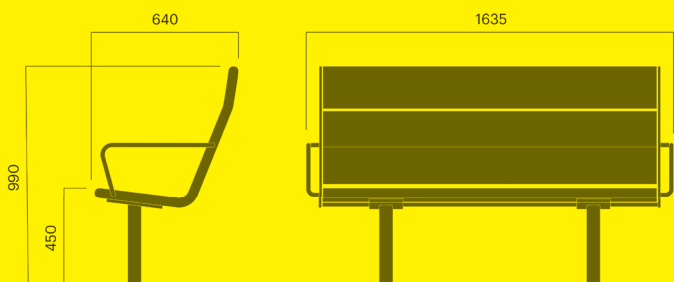

April Tisch, Stahl

niedrig, Verankerung A oder C		kg CO ₂ e	MJ	kg
Art. 732-900A	370 EUR	50	698	16
Art. 732-901A	320 EUR	50	698	16
Art. 732-900C	350 EUR	51	713	16
Art. 732-901C	300 EUR	51	713	16

hoch, Verankerung A oder C

Art. 730-900A	390 EUR	57	797	17
Art. 730-901A	320 EUR	57	797	17
Art. 730-900C	360 EUR	59	817	18
Art. 730-901C	300 EUR	59	817	18

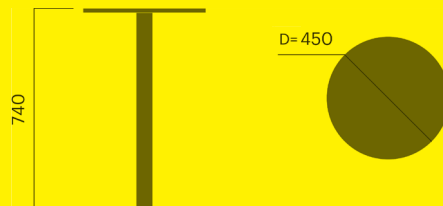

April Tisch, rund, kleiner Durchmesser

Verankerung A oder C		kg CO ₂ e	MJ	kg
Art. 731-900A	870 EUR	69	1 096	29
Art. 731-901A	790 EUR	69	1 096	29
Art. 731-900C	850 EUR	70	1 109	29
Art. 731-901C	770 EUR	70	1 109	29

freistehend

Art. 731-900	1 120 EUR	96	1 467	37
Art. 731-901	1 010 EUR	96	1 467	37



April Tisch, rund, großer Durchmesser

Verankerung A oder C		kg CO ₂ e	MJ	kg
Art. 737-900A	1 160 EUR	94	1 610	45
Art. 737-901A	1 050 EUR	94	1 610	45
Art. 737-900C	1 130 EUR	95	1 619	45
Art. 737-901C	1 030 EUR	95	1 619	45

freistehend

Art. 738-900	1 640 EUR	31	740	62
Art. 738-901	1 490 EUR	31	740	62

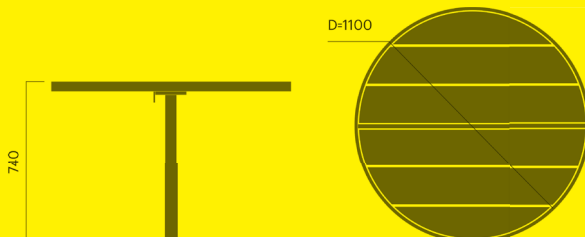

April Tisch, quadratisch

Verankerung A oder C		kg CO ₂ e	MJ	kg
Art. 734-900A	680 EUR	66	1 091	30
Art. 734-901A	600 EUR	66	1 091	30
Art. 734-900C	660 EUR	67	1 100	30
Art. 734-901C	580 EUR	67	1 100	30

freistehend

Art. 735-900	920 EUR	92	1 457	38
Art. 735-901	830 EUR	92	1 457	38

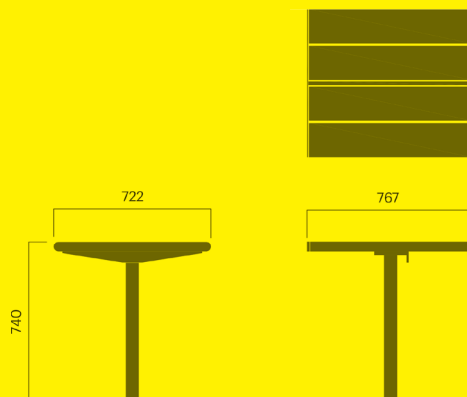

April Tisch, standard

Verankerung A oder C		kg CO ₂ e	MJ	kg
Art. 733-900A	1 060 EUR	110	1 914	54
Art. 733-901A	910 EUR	110	1 914	54
Art. 733-900C	1 020 EUR	111	1 937	55
Art. 733-901C	870 EUR	111	1 937	55

freistehend

Art. 736-900	1 240 EUR	127	2 158	60
Art. 736-901	1 050 EUR	127	2 158	60

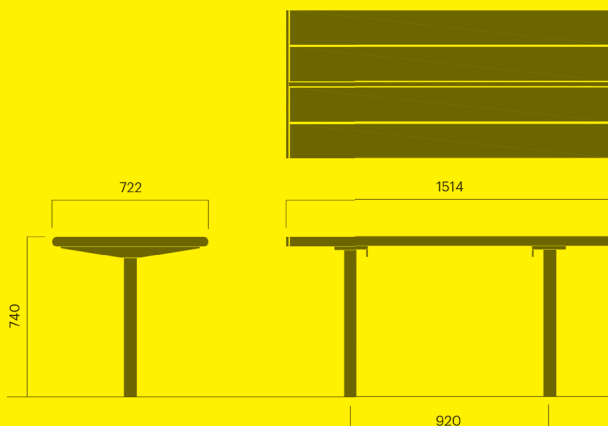

April Tisch

rollstuhlgerecht

Verankerung A oder C		kg CO ₂ e	MJ	kg
Art. 739-900A	1 130 EUR	112	1 979	57
Art. 739-901A	950 EUR	112	1 979	57
Art. 739-900C	1 090 EUR	114	2 007	58
Art. 739-901C	910 EUR	114	2 007	58

freistehend

Art. 739-900	1 270 EUR	130	2 227	63
Art. 739-901	1 080 EUR	130	2 227	63

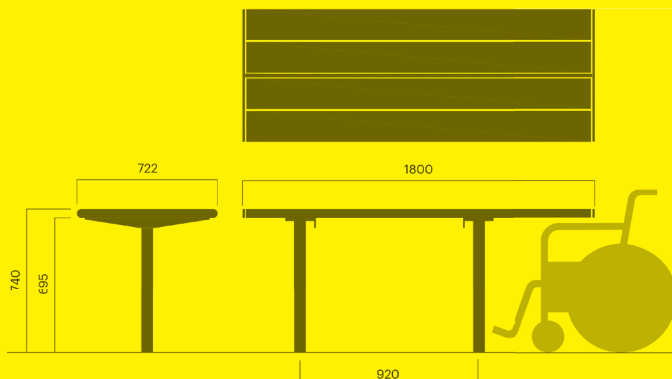

April Bartisch

Verankerung A oder C		kg CO ₂ e	MJ	kg
Art. 741-900A	910 EUR	97	1 632	37
Art. 741-901A	790 EUR	97	1 632	36
Art. 741-900C	880 EUR	98	1 651	37
Art. 741-901C	760 EUR	98	1 651	37

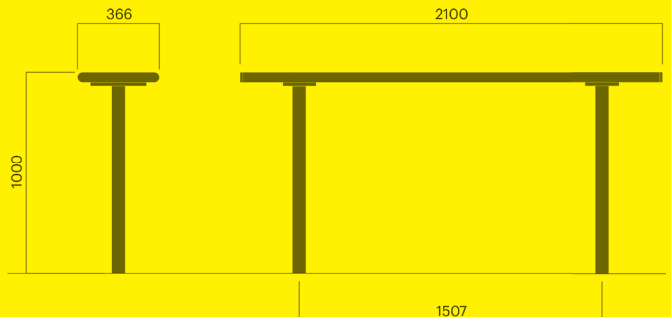

April Picknick Tischbank

ohne Rückenlehnen		kg CO ₂ e	MJ	kg
Art. 751-900	2 510 EUR	311	4 909	145
Art. 751-901	2 260 EUR	311	4 909	124

Rückenlehne einseitig

Art. 753-900	2 840 EUR	326	5 412	154
Art. 753-901	2 450 EUR	326	5 412	148

Rückenlehnen beidseitig

Art. 752-900	3 170 EUR	339	5 631	164
Art. 752-901	2 630 EUR	339	5 631	158

Rückenlehne einseitig, roll-stuhl-ge-recht

Art. 753-900H	3 200 EUR	344	5 794	157
Art. 753-901H	2 660 EUR	344	5 794	161

Bodenverankerung empfohlen

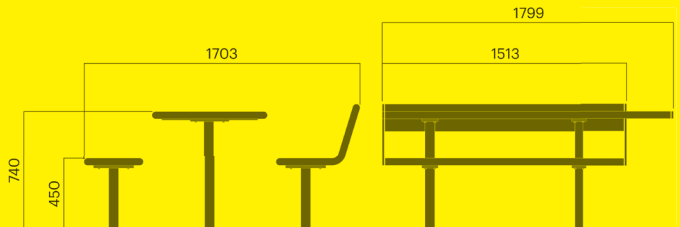

April Abfallbehälter

standard		kg CO ₂ e	MJ	kg
75 Liter				
Art. 780-900	1 260 EUR	112	1 574	35
Art. 780-901	1 060 EUR	112	1 574	35
95 Liter				
Art. 782-900	1 380 EUR	128	1 791	40
Art. 782-901	1 170 EUR	128	1 791	40

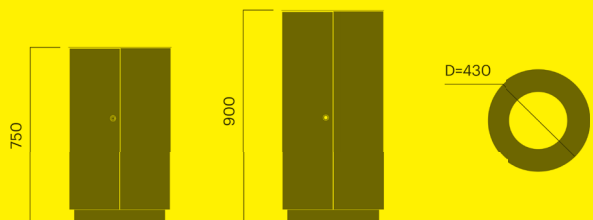

April Abfallbehälter

standard

		kg CO ₂ e	MJ	kg
145 Liter				
Art. 784-900	1 580 EUR	154	2 153	49
Art. 784-901	1 370 EUR	154	2 153	48
175 Liter				
Art. 786-900	1 780 EUR	176	2 450	60
Art. 786-901	1 520 EUR	176	2 450	60

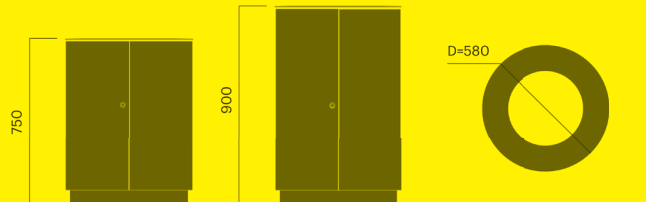

April Abfallbehälter

verstrebt einsehbar

		kg CO ₂ e	MJ	kg
75 Liter				
Art. 770-900	1 690 EUR	184	2 572	39
Art. 770-901	1 520 EUR	184	2 572	39
95 Liter				
Art. 772-900	1 800 EUR	237	3 307	48
Art. 772-901	1 630 EUR	237	3 307	48

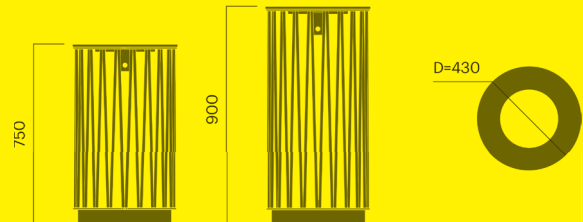

April Abfallbehälter

verstrebt einsehbar

		kg CO ₂ e	MJ	kg
145 Liter				
Art. 774-900	1 950 EUR	180	2 514	56
Art. 774-901	1 750 EUR	180	2 514	55
175 Liter				
Art. 776-900	2 050 EUR	325	4 541	67
Art. 776-901	1 870 EUR	325	4 541	67

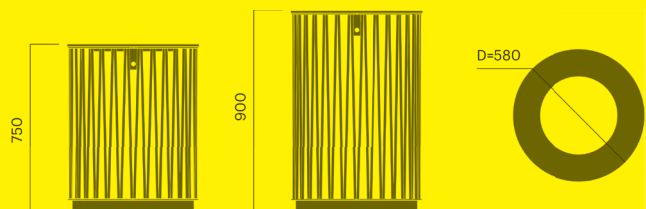

April Stavanger Hockerbank

Verankerung A, B, C oder MK		kg CO ₂ e	MJ	kg
Art. 720-900A	770 EUR	72	1204	32
Art. 720-901A	660 EUR	72	1204	32
Art. 720-900B	850 EUR	72	1204	33
Art. 720-901B	850 EUR	72	1204	33
Art. 720-900C	730 EUR	72	1204	33
Art. 720-901C	620 EUR	72	1204	33
Art. 720-900MK	700 EUR	47	852	25
Art. 720-901MK	590 EUR	47	852	25

freistehend

Art. 721-900	890 EUR	79	1298	35
Art. 721-901	780 EUR	79	1298	35

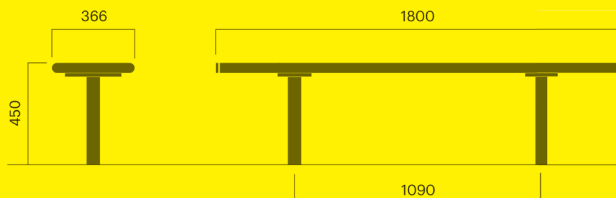

April Stavanger Hockerbank

mit Armlehnen, Verankerung A, B, C oder MK		kg CO ₂ e	MJ	kg
Art. 722-900A	1 000 EUR	86	1406	36
Art. 722-901A	900 EUR	86	1406	36
Art. 722-900B	1 050 EUR	88	1434	36
Art. 722-901B	950 EUR	88	1434	36
Art. 722-900C	950 EUR	88	1434	36
Art. 722-901C	860 EUR	88	1335	36
Art. 722-900MK	930 EUR	55	974	36
Art. 722-901MK	860 EUR	55	974	36

mit Armlehnen, freistehend

Art. 722-900	1 130 EUR	88	1434	50
Art. 722-901	1 030 EUR	88	1434	50

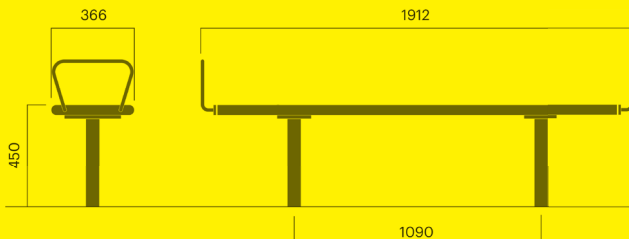

April Stavanger Bank

Verankerung A, B, C oder MK		kg CO ₂ e	MJ	kg
Art. 723-900A	980 EUR	86	1553	45
Art. 723-901A	830 EUR	86	1553	45
Art. 723-900B	1 100 EUR	87	1557	45
Art. 723-901B	940 EUR	87	1557	45
Art. 723-900C	940 EUR	88	1576	46
Art. 723-901C	790 EUR	88	1576	46
Art. 723-900MK	890 EUR	63	1224	38
Art. 723-901MK	770 EUR	63	1224	38

freistehend

Art. 726-900	1 060 EUR	99	1735	49
Art. 726-901	930 EUR	99	1735	49

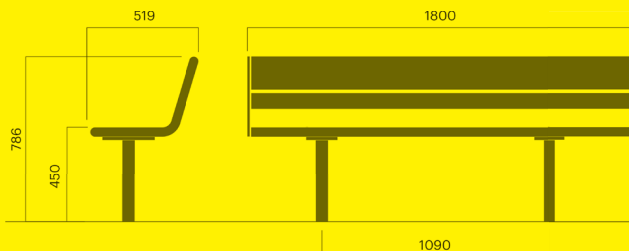

April Stavanger Bank

mit Armlehnen, Verankerung
A, B, C oder MK

		kg CO ₂ e	MJ	kg
Art. 724-900A	1 130 EUR	93	1 646	47
Art. 724-901A	950 EUR	93	1 646	47
Art. 724-900B	1 200 EUR	93	1 646	47
Art. 724-901B	1 130 EUR	93	1 646	47
Art. 724-900C	1 090 EUR	95	1 679	48
Art. 724-901C	910 EUR	95	1 679	48
Art. 724-900MK	1 090 EUR	69	1 313	40
Art. 724-901MK	910 EUR	69	1 313	40

freistehend

Art. 727-900	1 270 EUR	105	1 820	51
Art. 727-901	1 120 EUR	105	1 820	70

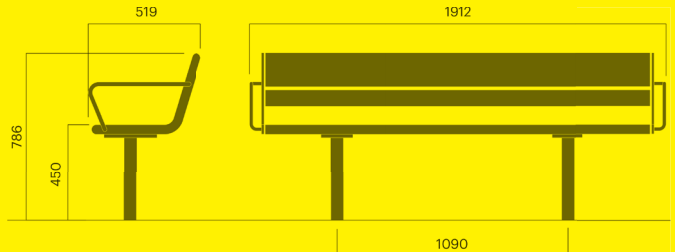

April Stavanger Tisch

Verankerung A oder C

		kg CO ₂ e	MJ	kg
Art. 743-900A	1 060 EUR	112	1 979	57
Art. 743-901A	940 EUR	112	1 979	57
Art. 743-900C	1 020 EUR	114	2 003	57
Art. 743-901C	900 EUR	114	2 003	57

freistehend

Art. 746-900	1 240 EUR	129	2 223	62
Art. 746-901	1 060 EUR	129	2 223	62

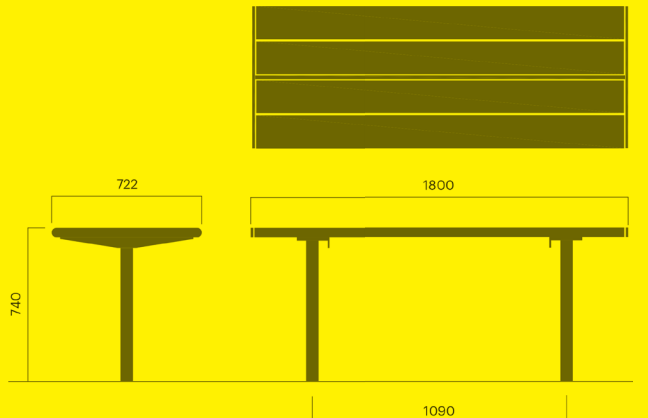

April Stavanger Picknick Tischbank

ohne Rückenlehne

		kg CO ₂ e	MJ	kg
Art. 755-900	2 880 EUR	317	5 248	149
Art. 755-901	2 440 EUR	317	5 248	143

Rückenlehne einseitig

Art. 757-900	3 080 EUR	326	5 230	162
Art. 757-901	2 760 EUR	326	5 230	156

Rückenlehnen beidseitig

Art. 756-900	3 190 EUR	341	5 549	174
Art. 756-901	2 870 EUR	341	5 549	181

ohne Rückenlehnen, Junior

		kg CO ₂ e	MJ	kg
Art. 755-900JR	2 770 EUR	317	5 248	139
Art. 755-901JR	2 330 EUR	317	5 248	142

Bodenverankerung empfohlen

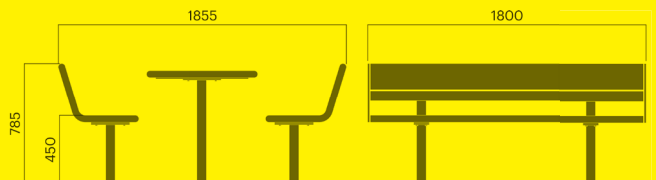



April Go Stuhl

Auflagen aus Aluminium		kg CO ₂ e	MJ	kg
Art. 7013-330	480 EUR	37	553	13
Art. 7013-331	400 EUR	37	553	13

Auflagen aus Holz		kg CO ₂ e	MJ	kg
Art. 7013-900	460 EUR	30	448	13
Art. 7013-901	400 EUR	30	448	11

Stapelbar

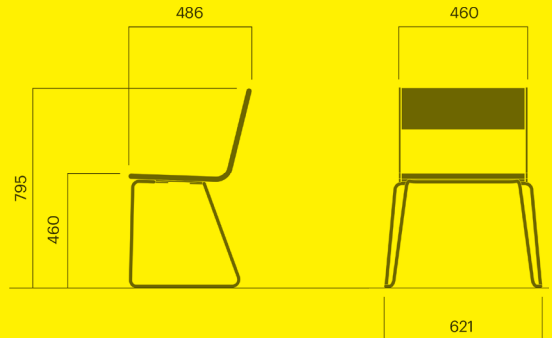

April Go Stuhl

mit Armlehnen, Auflagen aus Aluminium		kg CO ₂ e	MJ	kg
Art. 7014-330	590 EUR	40	612	14
Art. 7014-331	520 EUR	40	612	14

mit Armlehnen, Auflagen aus Holz		kg CO ₂ e	MJ	kg
Art. 7014-900	580 EUR	33	500	14
Art. 7014-901	530 EUR	33	500	13

Stapelbar

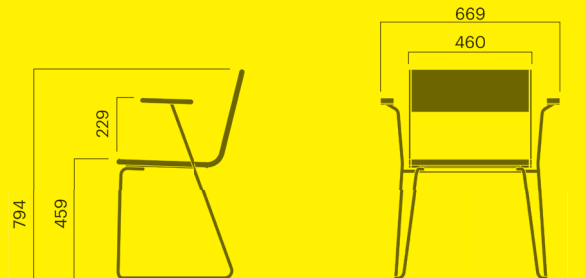

April Go Lounge Stuhl

Auflagen aus Holz		kg CO ₂ e	MJ	kg
Art. 7064-900	650 EUR	32	485	12
Art. 7064-901	520 EUR	32	485	13

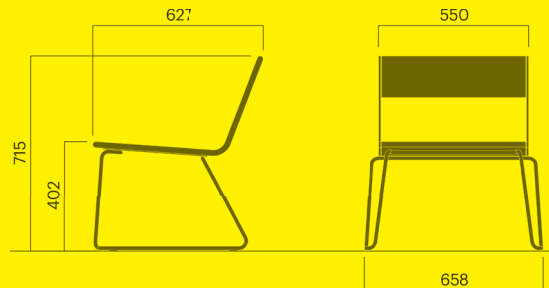

April Go Barstuhl

Auflagen aus Holz		kg CO ₂ e	MJ	kg
Art. 7018-900	680 EUR	32	475	14
Art. 7018-901	470 EUR	32	475	14

Stapelbar

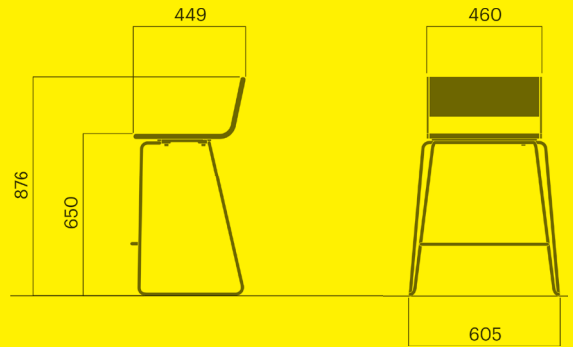

April Go Hockerbank

Auflagen aus Aluminium		kg CO ₂ e	MJ	kg
Art. 7006-330	550 EUR	36	572	15
Art. 7006-331	510 EUR	36	572	15

Auflagen aus Holz		kg CO ₂ e	MJ	kg
Art. 7006-900	610 EUR	36	572	15
Art. 7006-901	530 EUR	36	572	16

Stapelbar

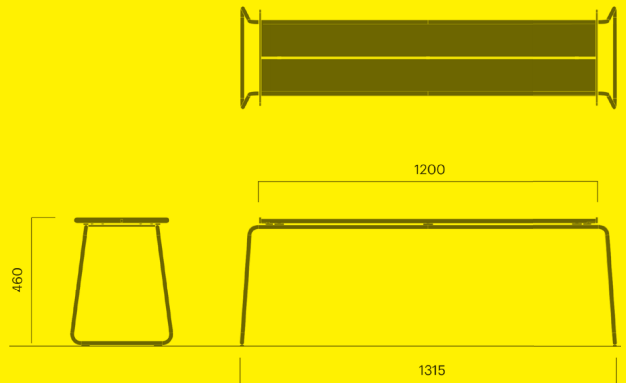

April Go Bank

ohne Armlehnen, Auflagen aus Aluminium		kg CO ₂ e	MJ	kg
Art. 7015-330	730 EUR	60	922	22
Art. 7015-331	610 EUR	60	922	22

ohne Armlehnen, Auflagen aus Aluminium		kg CO ₂ e	MJ	kg
Art. 7015-900	780 EUR	44	708	18
Art. 7015-901	670 EUR	44	708	18

mit Armlehnen, Auflagen aus Holz		kg CO ₂ e	MJ	kg
Art. 7016-900	940 EUR	47	760	19
Art. 7016-901	830 EUR	47	760	19

Stapelbar

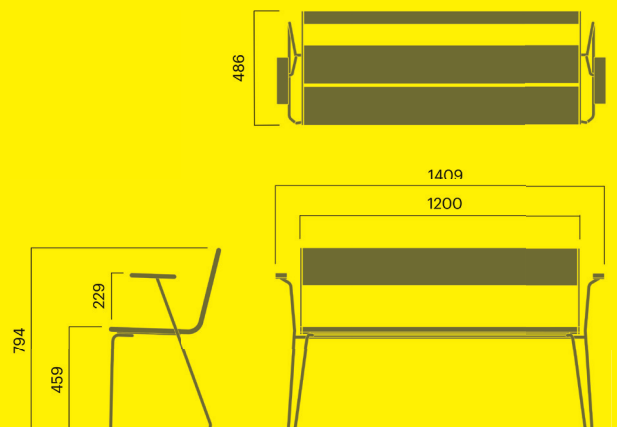

April Go Klappstisch

		kg CO ₂ e	MJ	kg
Tischplatte aus Aluminium				
Art. 7033-330	1 120 EUR	50	777	16
Art. 7033-331	1 020 EUR	50	777	20
Tischplatte aus Holz				
Art. 7033-900	820 EUR	38	503	13
Art. 7033-901	720 EUR	38	503	12

Klappbar

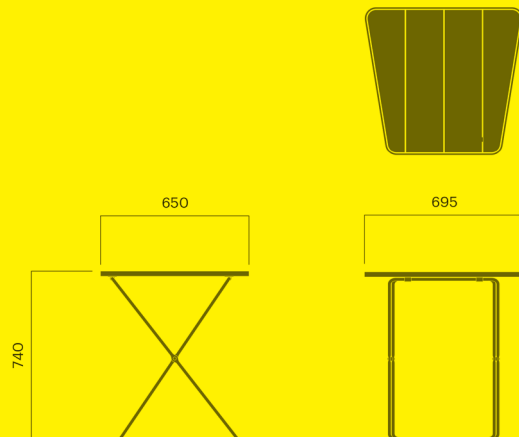

April Go Tisch, rund

		kg CO ₂ e	MJ	kg
Tischplatte aus Holz				
Art. 7037-900	1 080 EUR	47	752	24
Art. 7037-901	940 EUR	47	752	24

Klappbar

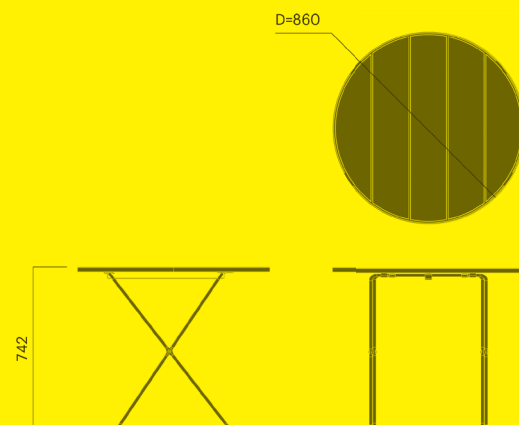

April Go Tisch, rechteckig

		kg CO ₂ e	MJ	kg
Tischplatte aus Aluminium				
Art. 7036-330	1 200 EUR	64	1 198	36
Art. 7036-331	1 080 EUR	64	1 198	36
Tischplatte aus Holz				
Art. 7036-900	1 180 EUR	64	1 198	27
Art. 7036-901	980 EUR	64	1 198	27

Klappbar

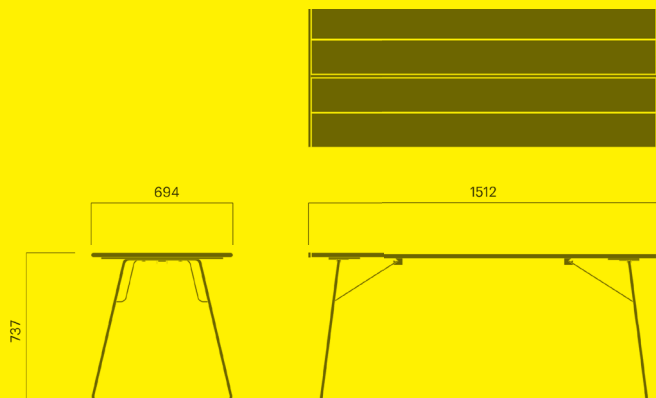

April Go Lounge Tisch

Tischplatte aus Holz		kg CO ₂ e	MJ	kg
Art. 7030-900	580 EUR	37	544	15
Art. 7030-901	460 EUR	37	544	15



April Go Pflanzkasten

H390/D650, 100 Liter		kg CO ₂ e	MJ	kg
Art. 7080-900	870 EUR	86	1 202	29
Art. 7080-901	780 EUR	86	1 202	29

H570/D650, 150 Liter		kg CO ₂ e	MJ	kg
Art. 7081-900	940 EUR	131	1 818	38
Art. 7081-901	830 EUR	131	1 818	38

H790/D650, 210 Liter		kg CO ₂ e	MJ	kg
Art. 7082-900	1 080 EUR	162	2 257	60
Art. 7082-901	960 EUR	162	2 257	60

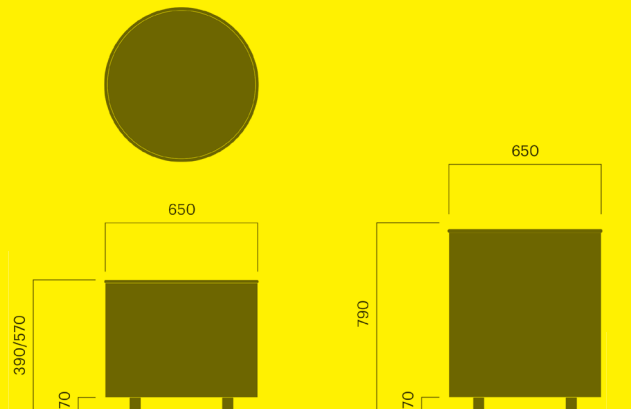

April Go Pflanzkasten

H390/D900, 150 Liter		kg CO ₂ e	MJ	kg
Art. 7083-900	970 EUR	165	2 300	49
Art. 7083-901	860 EUR	165	2 300	40

H570/D900, 300 Liter		kg CO ₂ e	MJ	kg
Art. 7084-900	1 380 EUR	201	2 805	74
Art. 7084-901	1 150 EUR	201	2 805	74

H820/T900, 460 Liter		kg CO ₂ e	MJ	kg
Art. 7085-900	1 690 EUR	220	3 069	71
Art. 7085-901	1 560 EUR	220	3 069	70

H840/D2100, 800 Liter		kg CO ₂ e	MJ	kg
Art. 7087-900	2 680 EUR	498	6 930	168
Art. 7087-901	2 380 EUR	498	6 930	168

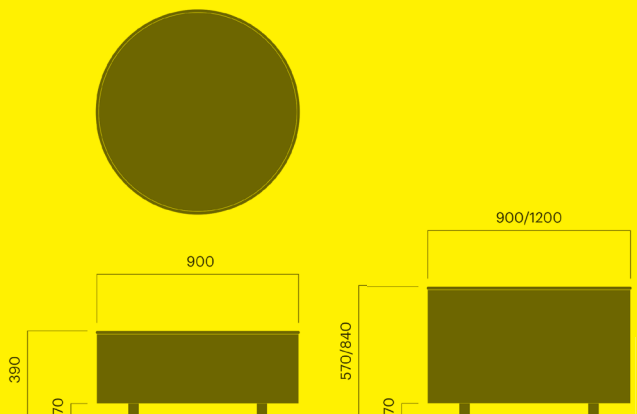



Atlas Hockerbank

2-Sitzer		kg CO ₂ e	MJ	kg
Art. 4502-900	1 760 EUR	159	2 007	70
Art. 4502-901	1 480 EUR	159	2 007	70
3-Sitzer				
Art. 4503-900	2 410 EUR	225	3 394	84
Art. 4503-901	2 040 EUR	225	3 394	84
4-Sitzer				
Art. 4504-900	3 110 EUR	290	4 392	130
Art. 4504-901	2 640 EUR	290	4 392	130

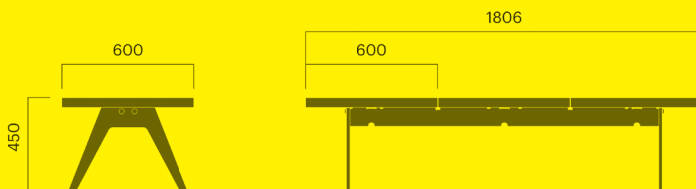

Atlas Bank

2-Sitzer		kg CO ₂ e	MJ	kg
Art. 4512-900	2 550 EUR	235	3 725	90
Art. 4512-901	2 350 EUR	235	3 725	90
3-Sitzer				
Art. 4513-900	3 580 EUR	198	2 982	133
Art. 4513-901	3 350 EUR	198	2 982	133
4-Sitzer				
Art. 4514-900	4 680 EUR	434	6 937	174
Art. 4514-901	4 390 EUR	434	6 937	174

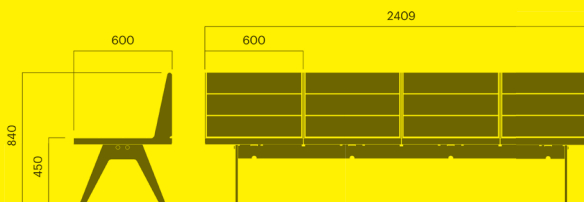

Atlas Doppelbank

ohne Armlehnen		kg CO ₂ e	MJ	kg
Art. 4527-900	6 140 EUR	589	9 283	240
Art. 4527-901	5 770 EUR	589	9 283	240
mit je einer Armlehne pro Seite, mittig				
Art. 4528-900	6 630 EUR	620	9 710	252
Art. 4528-901	6 120 EUR	620	9 710	252

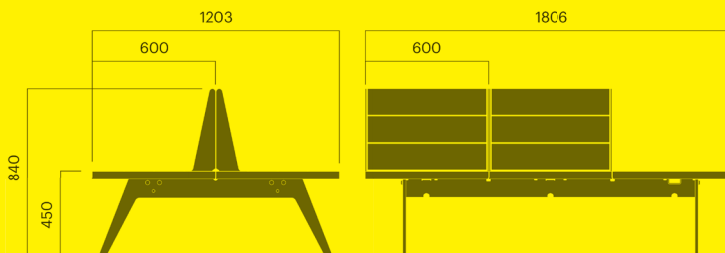

Atlas Sitzauflage

gerade		kg CO ₂ e	MJ	kg
Art. 4520-900	550 EUR	31	523	14
Art. 4520-901	470 EUR	31	523	14
gebogen		kg CO ₂ e	MJ	kg
Art. 4530-900	1 100 EUR	86	1 391	37
Art. 4530-901	1 030 EUR	86	1 391	37

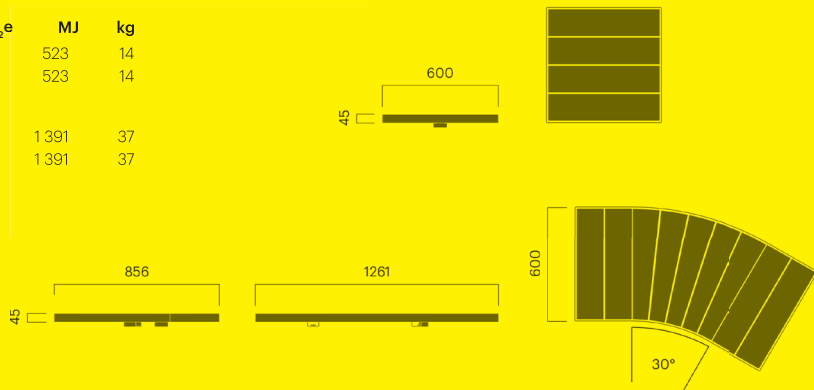

Atlas Sitzauflage

mit Rückenlehne		kg CO ₂ e	MJ	kg
Art. 4521-900	940 EUR	67	1 157	33
Art. 4521-901	910 EUR	67	1 157	33
mit Rücken- und einer Armlehne links (V) oder rechts (H)		kg CO ₂ e	MJ	kg
Art. 4526-900V	1 110 EUR	83	1 392	38
Art. 4526-901V	1 030 EUR	83	1 392	38
Art. 4526-900H	1 110 EUR	83	1 392	38
Art. 4526-901H	1 030 EUR	83	1 392	38

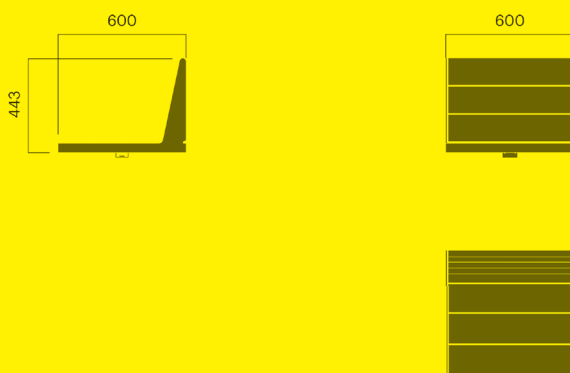

Atlas Untergestell

2-Sitzer		kg CO ₂ e	MJ	kg
Art. 4550-900	660 EUR	101	1 407	32
Art. 4550-901	540 EUR	101	1 407	32
3-Sitzer		kg CO ₂ e	MJ	kg
Art. 4551-900	760 EUR	131	1 864	41
Art. 4551-901	630 EUR	131	1 864	41
4-Sitzer		kg CO ₂ e	MJ	kg
Art. 4552-900	920 EUR	165	2 296	52
Art. 4552-901	760 EUR	165	2 296	52

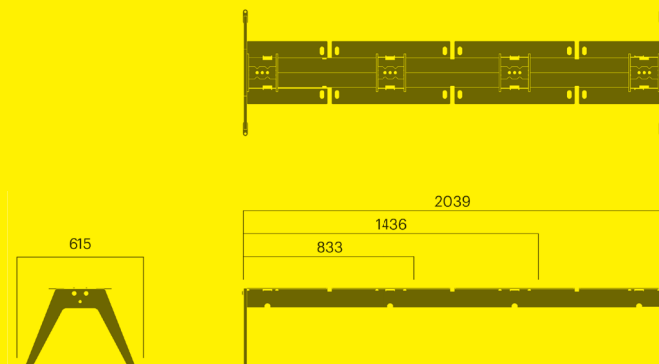

Atlas Untergestell, zweireihig

4 Sitze (2+2)

		kg CO ₂ e	MJ	kg
Art. 4560-900	1100 EUR	193	2 697	63
Art. 4560-901	960 EUR	193	2 697	63

6 Sitze (3+3)

		kg CO ₂ e	MJ	kg
Art. 4561-900	1390 EUR	258	3 593	82
Art. 4561-901	1140 EUR	258	3 593	82

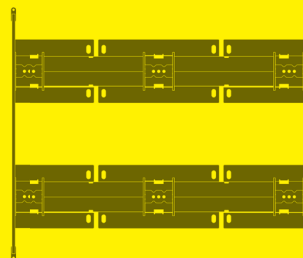

Berg



Berg Picknick Tischbank

		kg CO ₂ e	MJ	kg
Art. 322-900	1790 EUR	106	1 934	58
Art. 322-901	1590 EUR	106	1 934	58

rollstuhlgerecht

		kg CO ₂ e	MJ	kg
Art. 322-900HC	1890 EUR	136	2 465	65
Art. 322-901HC	1690 EUR	136	2 465	65

Bodenverankerung empfohlen

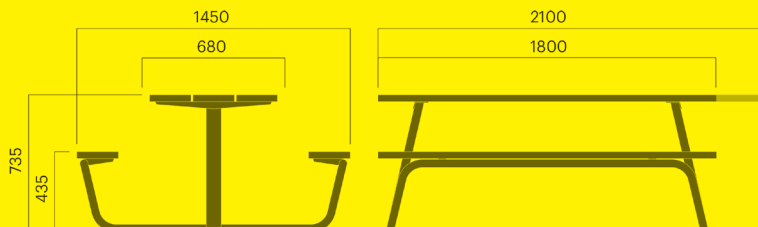

Berg Fahrradständer

für 6 Fahrräder

		kg CO ₂ e	MJ	kg
Art. 393-900	890 EUR	110	1 534	30
Art. 393-901	740 EUR	110	1 534	50

für 8 Fahrräder

		kg CO ₂ e	MJ	kg
Art. 395-900	1090 EUR	150	2 083	42
Art. 395-901	950 EUR	150	2 083	31

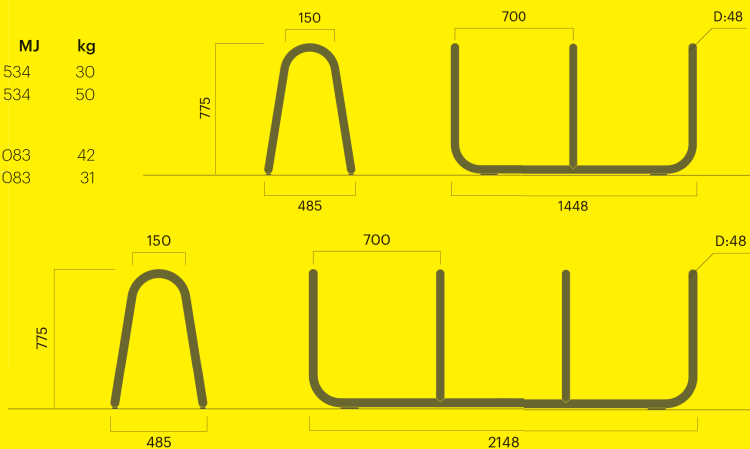



Berlin Stuhl

Verankerung A oder C		kg CO ₂ e	MJ	kg
Art. 3713-900A	1 200 EUR	74	1 150	28
Art. 3713-901A	1 090 EUR	74	1 150	26
Art. 3713-900C	1 170 EUR	77	1 192	30
Art. 3713-901C	1 050 EUR	77	1 192	30
mit Armlehnen, Verankerung A oder C				
Art. 3717-900A	1 380 EUR	90	1 371	35
Art. 3717-901A	1 270 EUR	90	1 371	35
Art. 3717-900C	1 350 EUR	92	1 398	34
Art. 3717-901C	1 240 EUR	92	1 398	34

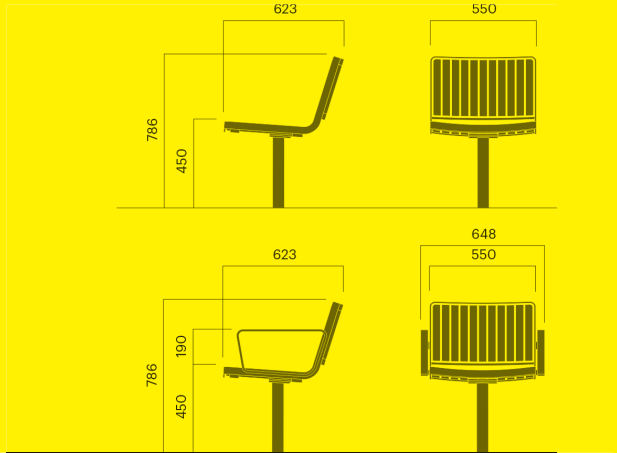

Berlin Stuhl

freistehend		kg CO ₂ e	MJ	kg
Art. 3718-900	1 460 EUR	93	1 405	32
Art. 3718-901	1 340 EUR	93	1 405	32
mit Armlehnen, freistehend				
Art. 3717-900	1 560 EUR	97	1 464	36
Art. 3717-901	1 410 EUR	97	1 464	36

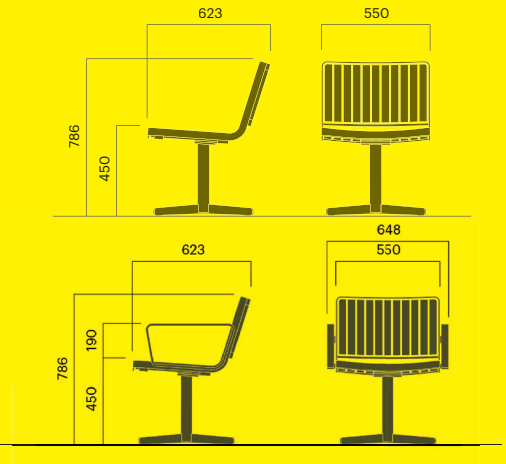

Berlin Tisch, klein

Verankerung A oder C		kg CO ₂ e	MJ	kg
Art. 3731-900A	630 EUR	64	896	22
Art. 3731-901A	520 EUR	64	896	20
Art. 3731-900C	610 EUR	65	905	20
Art. 3731-901C	500 EUR	65	905	20
freistehend				
Art. 3731-900	740 EUR	72	999	22
Art. 3731-901	630 EUR	72	999	21

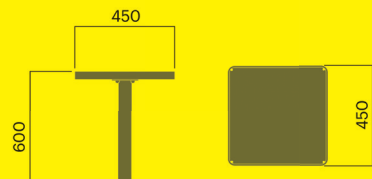

Berlin Tisch, groß

Verankerung A oder C		kg CO ₂ e	MJ	kg
Art. 3733-900A	950 EUR	141	1 965	45
Art. 3733-901A	850 EUR	141	1 965	45
Art. 3733-900C	930 EUR	142	1 975	44
Art. 3733-901C	820 EUR	142	1 975	45
freistehend				
Art. 3733-900	1 060 EUR	147	2 054	47
Art. 3733-901	940 EUR	147	2 054	47

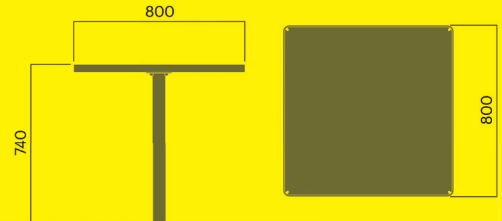

Bloc



Bloc Stuhl

ohne Armlehnen		kg CO ₂ e	MJ	kg
Art. 1503-900	1 260 EUR	180	2 672	65
Art. 1503-901	1 050 EUR	180	2 672	65
mit Armlehnen				
Art. 1504-900	1 380 EUR	199	2 934	71
Art. 1504-901	1 120 EUR	199	2 934	71

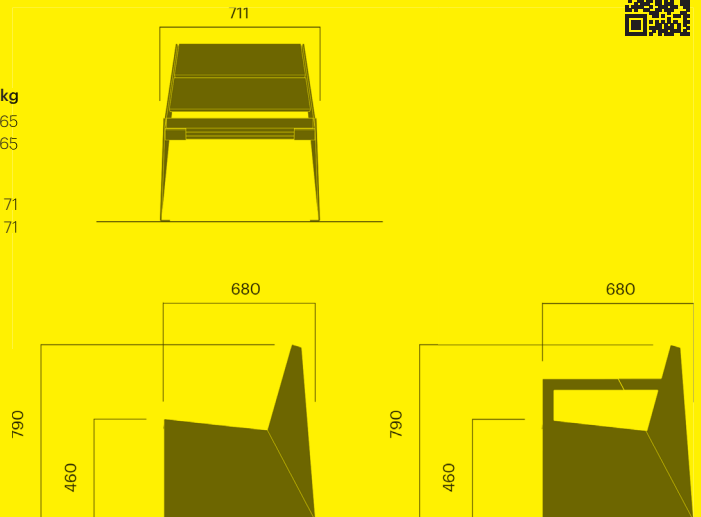

Bloc Barhocker

		kg CO ₂ e	MJ	kg
Art. 1521-900	1 280 EUR	144	2 285	62
Art. 1521-901	1 140 EUR	144	2 285	62

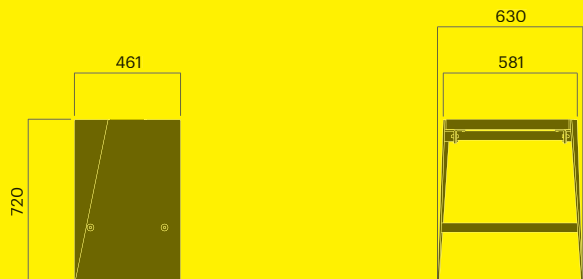

Bloc Barstuhl

		kg CO ₂ e	MJ	kg
Art. 1523-900	1 580 EUR	234	3 478	85
Art. 1523-901	1 280 EUR	234	3 478	85

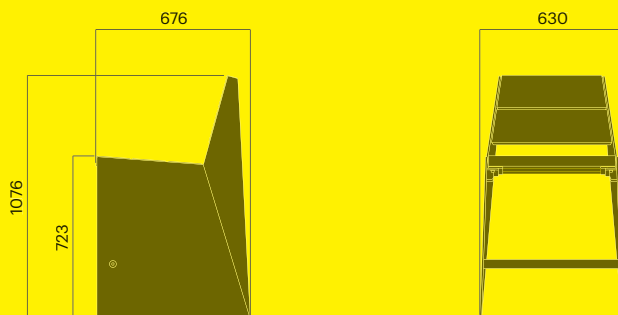

Bloc Hockerbank

alleinstehend		kg CO ₂ e	MJ	kg
Art. 1506-900	1 080 EUR	145	2 304	60
Art. 1506-901	960 EUR	145	2 304	60

Startmodul

Art. 1507-901	1 050 EUR	152	2 398	62
Art. 1507-900	1 200 EUR	152	2 398	62



Bloc Hockerbank

Anbaumodul		kg CO ₂ e	MJ	kg
Art. 1508-901	810 EUR	99	1 665	46
Art. 1508-900	920 EUR	99	1 665	46

Endmodul

Art. 1509-900	870 EUR	94	1 590	44
Art. 1509-901	760 EUR	94	1 590	44

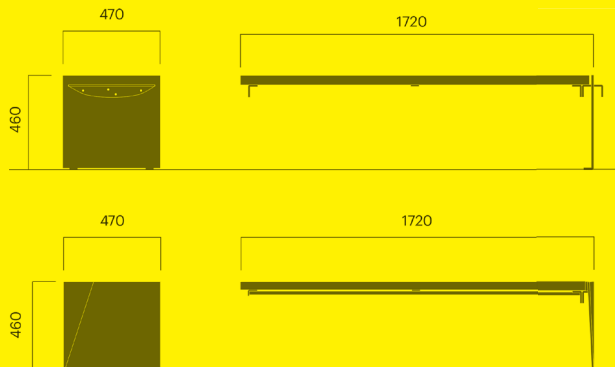

Bloc Bank

alleinstehend		kg CO ₂ e	MJ	kg
Art. 1516-900	1 490 EUR	201	3 273	88
Art. 1516-901	1 280 EUR	201	3 273	88

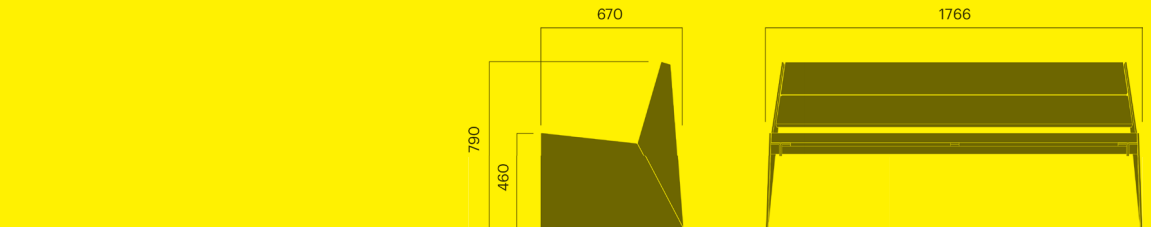

Bloc Bank, Startmodul

		kg CO ₂ e	MJ	kg
Art. 1553-900	1 700 EUR	209	3 374	89
Art. 1553-901	1 430 EUR	209	3 374	89

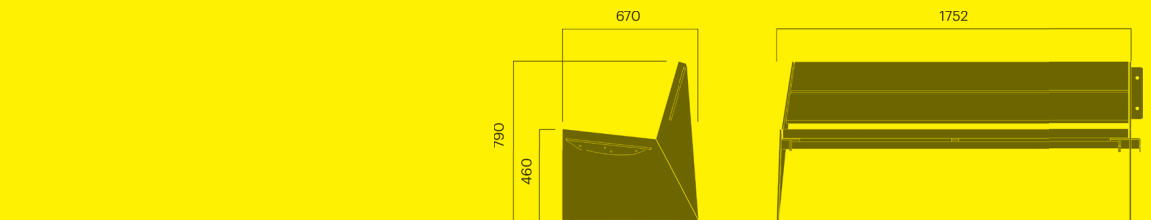

Bloc Bank, Anbaumodul

		kg CO ₂ e	MJ	kg
Art. 1554-900	1 330 EUR	134	2 351	66
Art. 1554-901	1 160 EUR	134	2 351	66

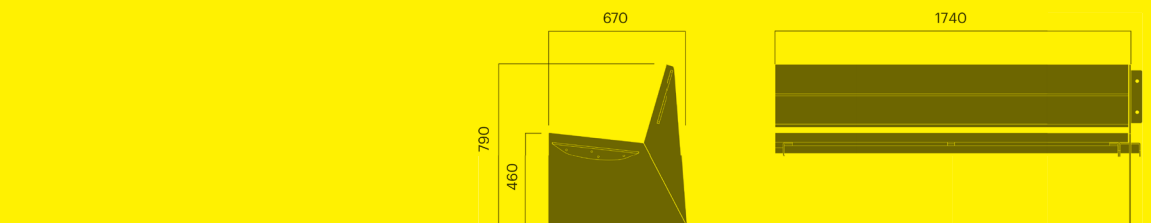

Bloc Bank, Endmodul

		kg CO ₂ e	MJ	kg
Art. 1555-900	1 240 EUR	127	2 230	63
Art. 1555-901	1 060 EUR	127	2 230	63

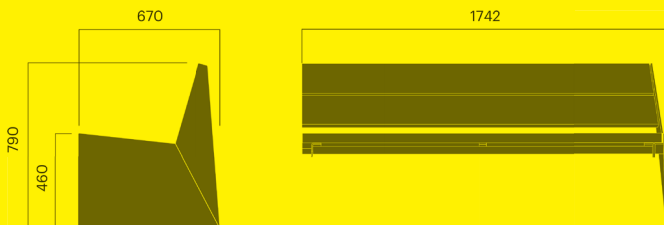

Bloc Bank

		kg CO ₂ e	MJ	kg
mit Armlehnen, alleinstehend				
Art. 1517-900	1 700 EUR	221	3 546	94
Art. 1517-901	1 370 EUR	221	3 546	94

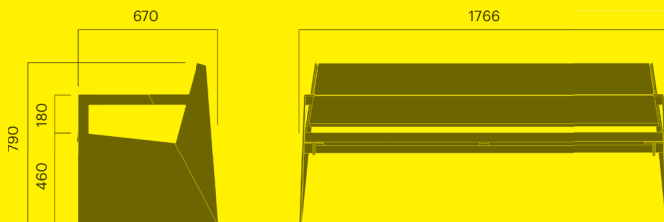

Bloc Bank, Startmodul eine Armlehne, an Außen- wange

		kg CO ₂ e	MJ	kg
Art. 1556-900	1 780 EUR	218	3 505	92
Art. 1556-901	1 470 EUR	218	3 505	92

mit Armlehnen beidseitig, zum Anbauen

		kg CO ₂ e	MJ	kg
Art. 1559-900	1 810 EUR	218	3 505	96
Art. 1559-901	1 500 EUR	218	3 505	96

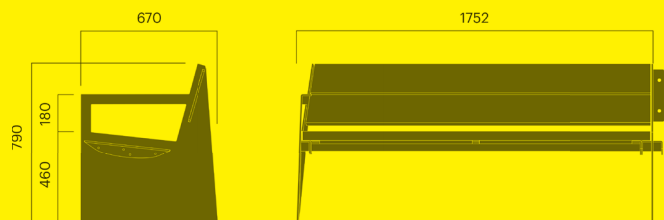

Bloc Bank, Anbaumodul

eine Armlehne		kg CO ₂ e	MJ	kg
Art. 1557-900	1 340 EUR	144	2 478	68
Art. 1557-901	1 210 EUR	144	2 478	68

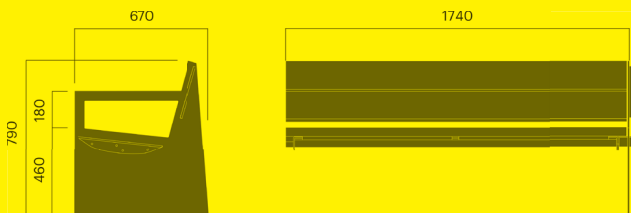

Bloc Bank, Endmodul

mit Armlehne nur an Außenwange		kg CO ₂ e	MJ	kg
Art. 1558-900	1 290 EUR	136	2 361	66
Art. 1558-901	1 090 EUR	136	2 361	66

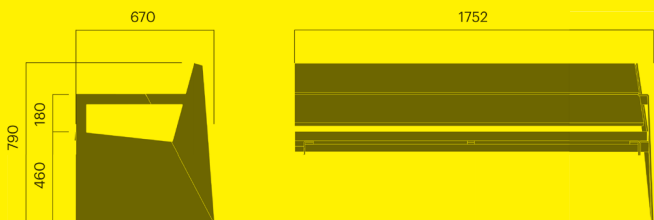

Bloc Bank, Rücken an Rücken, komplett

		kg CO ₂ e	MJ	kg
Art. 1532-900	3 710 EUR	442	7 201	192
Art. 1532-901	3 040 EUR	442	7 201	192

Startmodul, ohne Armlehnen, zum Anbauen

Art. 1574-900	3 630 EUR	456	7 381	196
Art. 1574-901	3 170 EUR	456	7 381	196

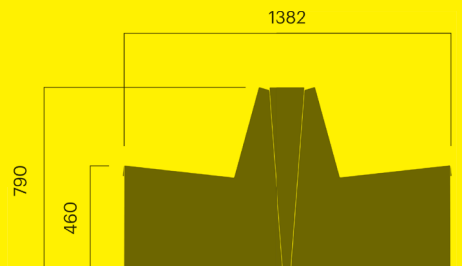

Bloc Bank, Rücken an Rücken, komplett

mit Armlehnen		kg CO ₂ e	MJ	kg
Art. 1534-900	3 790 EUR	480	7 730	204
Art. 1534-901	3 190 EUR	480	7 730	204

Startmodul mit Armlehne nur an Startwange, zum Anbauen

Art. 1571-900	3 670 EUR	476	7 655	202
Art. 1571-901	3 250 EUR	476	7 655	202

Startmodul mit Armlehnen beiseitig, zum Anbauen

Art. 1570-900	3 790 EUR	476	7 655	208
Art. 1570-901	3 240 EUR	476	7 655	208

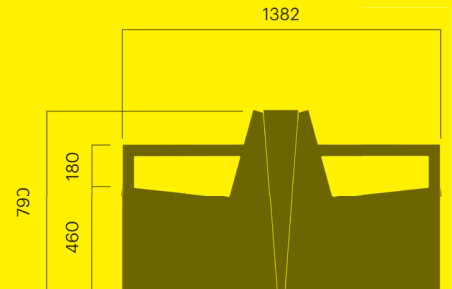

Bloc Bank, Anbaumodul, Rücken an Rücken

ohne Armlehnen		kg CO ₂ e	MJ	kg
Art. 1572-900	2 410 EUR	282	4 779	131
Art. 1572-901	2 310 EUR	282	4 779	131

je eine Armlehne pro Seite, zum Anbauen

Art. 1533-900	2 490 EUR	300	5 032	137
Art. 1533-901	2 270 EUR	300	5 032	137

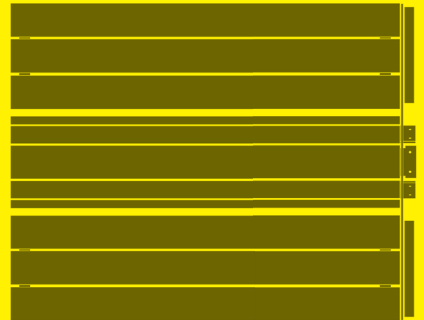

Bloc Bank, Rücken an Rücken, Endmodul

ohne Armlehnen		kg CO ₂ e	MJ	kg
Art. 1575-900	2 820 EUR	274	4 849	138
Art. 1575-901	2 410 EUR	274	4 849	138

je eine Armlehne pro Seite, an Endwange

Art. 1573-900	2 870 EUR	385	5 832	144
Art. 1573-901	2 480 EUR	385	5 832	144

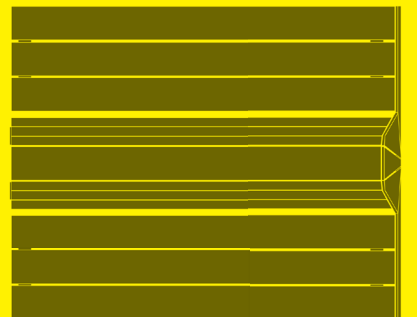

Bloc Liegebank

regulär		kg CO ₂ e	MJ	kg
Art. 1566-900	2 390 EUR	303	4 970	134
Art. 1566-901	1 980 EUR	303	4 970	134
schmal				
Art. 1565-900	2 290 EUR	303	4 970	120
Art. 1565-901	1 890 EUR	303	4 970	120

Aufpreis für Rollensatz: 350 EUR

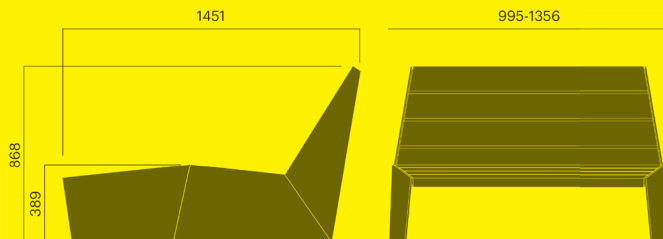

Bloc Liegebank, Startmodul

regulär auf regulär		kg CO ₂ e	MJ	kg
Art. 1567-900	2 590 EUR	316	5 173	139
Art. 1567-901	2 110 EUR	316	5 173	139
Übergang zu kurzer Liege				
Art. 1567-900K	2 480 EUR	312	5 115	139
Art. 1567-901K	2 070 EUR	312	5 115	139

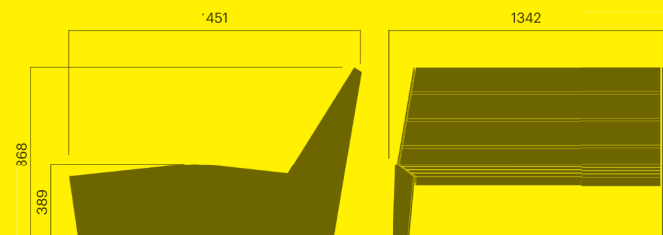

Bloc Liegebank, Anbaumodul

regulär auf regulär		kg CO ₂ e	MJ	kg
Art. 1568-900	1 990 EUR	187	3 347	97
Art. 1568-901	1 840 EUR	187	3 347	97
Übergang zu kurzer Liege				
Art. 1568-900K	1 940 EUR	183	3 288	92
Art. 1568-901K	1 800 EUR	183	3 288	96

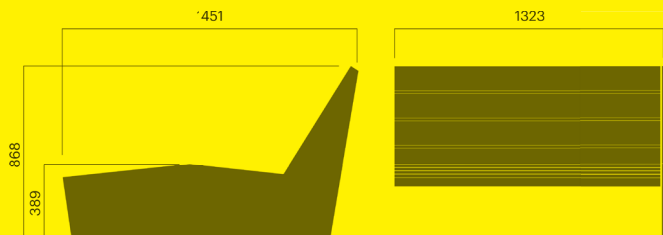

Bloc Liegebank, Endmodul

		kg CO ₂ e	MJ	kg
Art. 1569-900	1 780 EUR	175	3 180	94
Art. 1569-901	1 520 EUR	175	3 180	94

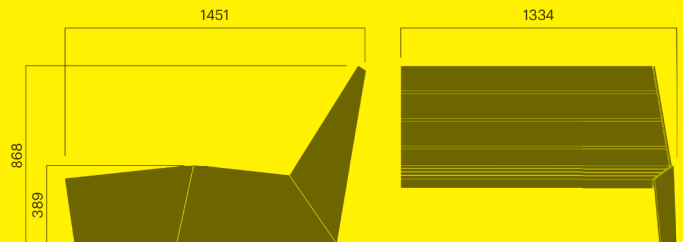

Bloc Liegebank

Rückenkopplung, alleinstehend		kg CO ₂ e	MJ	kg
Art. 1560-901	850 EUR	67	1 009	25
Art. 1560-900	950 EUR	67	1 009	25

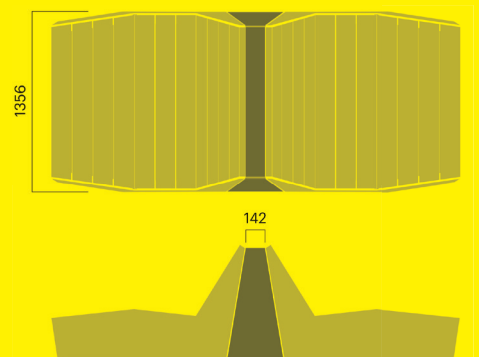

Bloc Liegebank, Rücken an Rücken, Startmodul

Rückenkopplung		kg CO ₂ e	MJ	kg
Art. 1561-901	850 EUR	127	1 849	20
Art. 1561-900	950 EUR	127	1 849	20

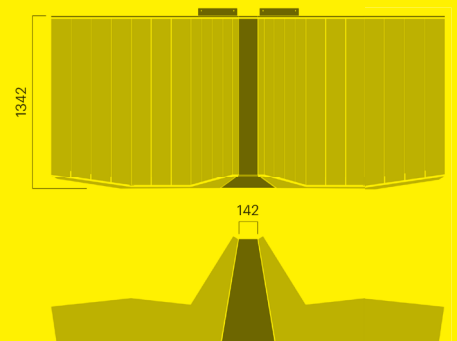

Bloc Liegebank, Rücken an Rücken

Anbaumodul		kg CO ₂ e	MJ	kg
Art. 1562-900	620 EUR	63	957	42
Art. 1562-901	510 EUR	63	957	42
Endmodul				
Art. 1563-900	620 EUR	67	1 009	24
Art. 1563-901	510 EUR	67	1 009	24



Bloc Liegebank, kurz

alleinstehend		kg CO ₂ e	MJ	kg
Art. 1576-900	1 690 EUR	194	3 185	86
Art. 1576-901	1 480 EUR	194	3 185	86

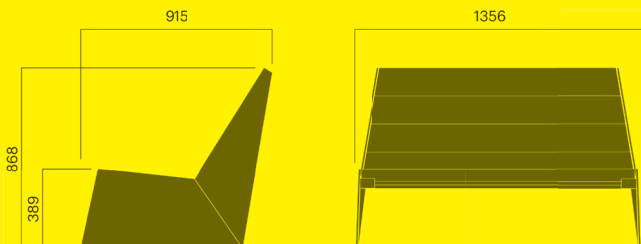

Bloc Liegebank, kurz, Startmodul

kurz auf kurz		kg CO ₂ e	MJ	kg
Art. 1577-900	1 800 EUR	239	3 816	130
Art. 1577-901	1 630 EUR	239	3 816	130
Übergang zu langer Liege				
Art. 1577-900K	2 130 EUR	274	4 367	130
Art. 1577-901K	1 900 EUR	274	4 367	130

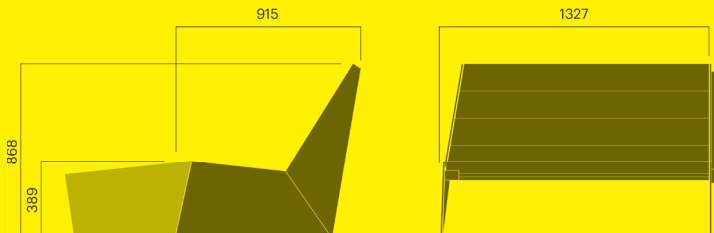

Bloc Liegebank, kurz, Anbaumodul

kurz auf kurz, zum Anbauen		kg CO ₂ e	MJ	kg
Art. 1578-900	1 330 EUR	152	2 454	65
Art. 1578-901	1 160 EUR	152	2 454	65
Übergang zu langer Liege				
Art. 1578-900K	1 540 EUR	181	3 005	65
Art. 1578-901K	1 340 EUR	181	3 005	65

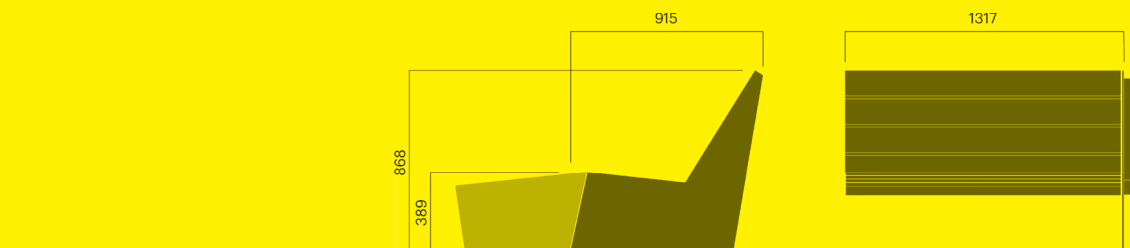

Bloc Liegebank, kurz, Endmodul

		kg CO ₂ e	MJ	kg
Art. 1579-900	1 260 EUR	108	1 862	71
Art. 1579-901	1 160 EUR	108	1 862	71

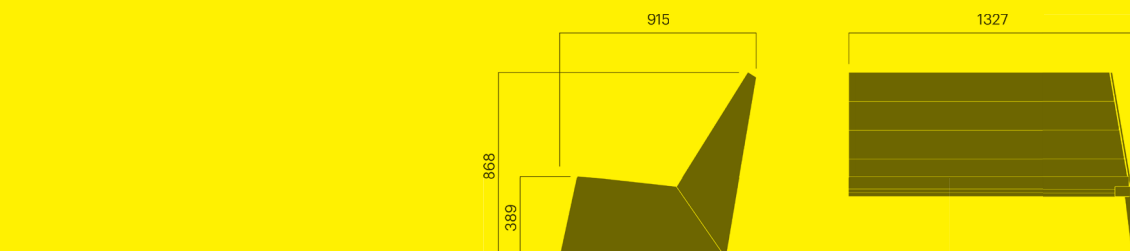

Bloc Tisch, niedrig

		kg CO ₂ e	MJ	kg
Art. 1530-900	1 260 EUR	155	2 372	60
Art. 1530-901	1 170 EUR	155	2 372	60

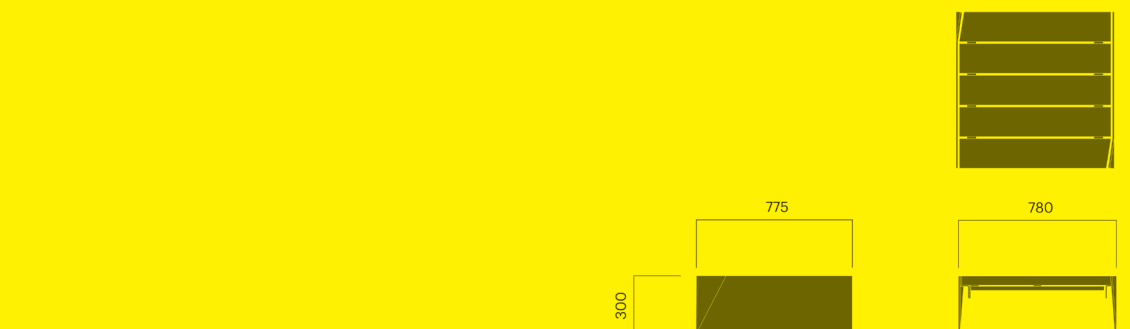

Bloc Tisch

		kg CO ₂ e	MJ	kg
alleinstehend				
Art. 1536-900	1 700 EUR	273	4 180	102
Art. 1536-901	1 480 EUR	273	4 180	102
Startmodul				
Art. 1537-900	1 700 EUR	273	4 180	105
Art. 1537-901	1 460 EUR	273	4 180	111

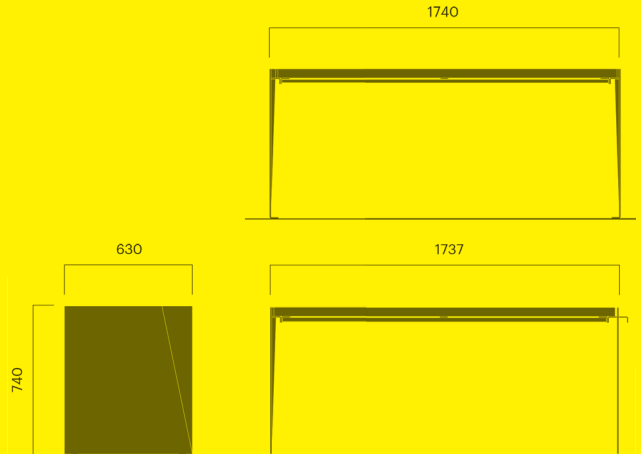

Bloc Tisch

		kg CO ₂ e	MJ	kg
Anbaumodul				
Art. 1538-900	1 220 EUR	166	2 697	72
Art. 1538-901	1 100 EUR	166	2 697	72
Endmodul				
Art. 1539-900	1 220 EUR	158	2 575	69
Art. 1539-901	1 050 EUR	158	2 575	69

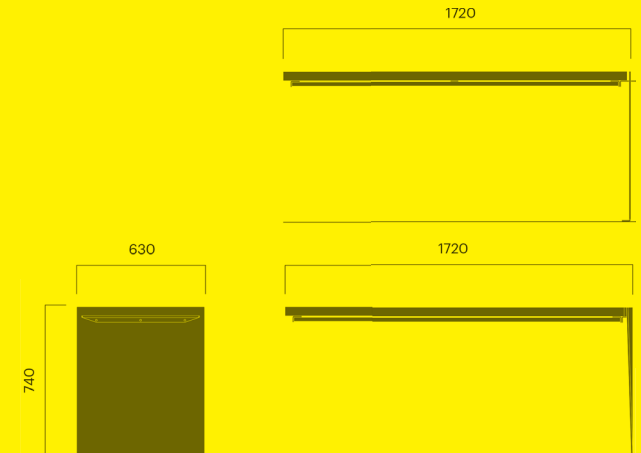

Bloc Bartisch

		kg CO ₂ e	MJ	kg
Art. 1531-900	1 980 EUR	359	5 500	134
Art. 1531-901	1 680 EUR	359	5 500	134

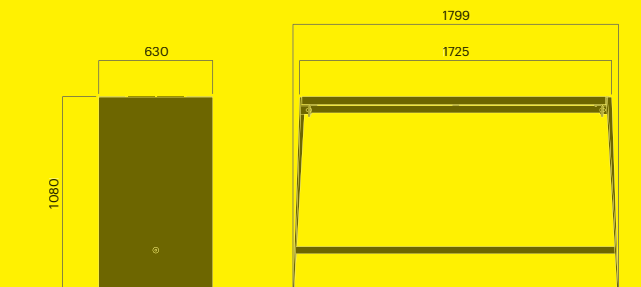

Bloc Abfallbehälter

100 Liter		kg CO ₂ e	MJ	kg
Art. 1546-900	1 340 EUR	164	2 290	51
Art. 1546-901	1 120 EUR	164	2 290	51

für Wandmontage

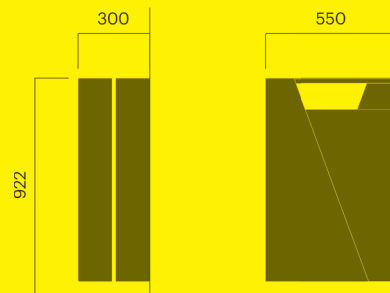

Bloc Abfallbehälter

100 Liter		kg CO ₂ e	MJ	kg
Art. 1542-900	1 460 EUR	229	3 236	72
Art. 1542-901	1 260 EUR	229	3 236	72

100 Liter, mit Aschenbecher

Art. 1543-900	1 660 EUR	231	3 232	74
Art. 1543-901	1 440 EUR	231	3 232	74

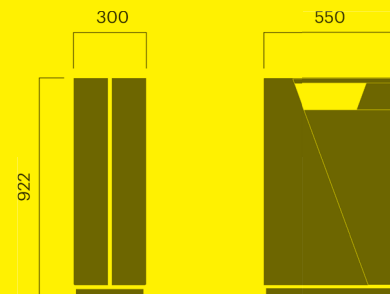

Bloc Abfallbehälter

140 Liter		kg CO ₂ e	MJ	kg
Art. 1544-900	2 020 EUR	355	4 958	104
Art. 1544-901	1 800 EUR	355	4 958	104

140 Liter, mit Aschenbecher

Art. 1545-900	2 300 EUR	329	4 596	105
Art. 1545-901	2 050 EUR	329	4 596	105

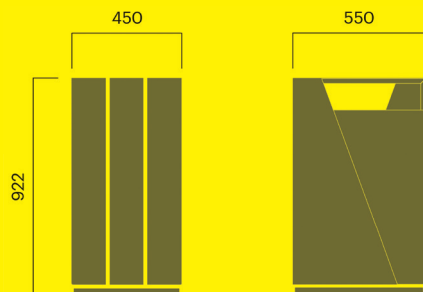

Bloc Mülltrennsystem

2 x 100 Liter		kg CO ₂ e	MJ	kg
Art. 1548-900	2 680 EUR	331	4 672	103
Art. 1548-901	2 280 EUR	331	4 672	103
3 x 100 Liter				
Art. 1549-900	3 980 EUR	497	7 019	154
Art. 1549-901	3 380 EUR	497	7 019	154
2 x 100 Liter, mit Einsatz				
Art. 1548-900L	3 360 EUR	353	4 982	109
Art. 1548-901L	2 960 EUR	353	4 982	109
3 x 100 Liter mit Einsatz				
Art. 1549-900L	4 980 EUR	529	7 475	164
Art. 1549-901L	4 380 EUR	529	7 475	164

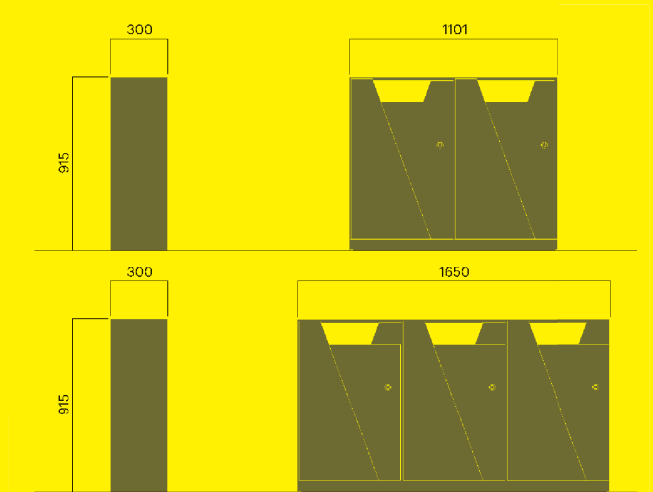

Bloc liner

Einsatz für Abfallbehälter		kg CO ₂ e	MJ	kg
70 liter				
Art. 15991-901	290 EUR	22	308	7
Art. 15992-901	340 EUR	18	260	6

Bloc Pflanzkasten

45 Liter		kg CO ₂ e	MJ	kg
Art. 1581-900	1 020 EUR	187	2 601	59
Art. 1581-901	880 EUR	187	2 601	59
200 Liter				
Art. 1582-900	1 860 EUR	408	5 677	130
Art. 1582-901	1 580 EUR	408	5 677	130

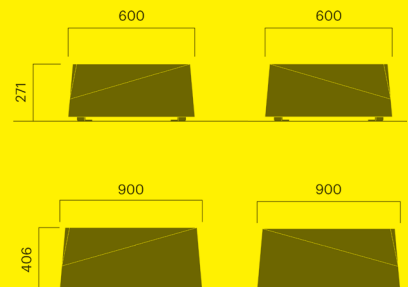

Bloc Pflanzkasten

520 Liter		kg CO ₂ e	MJ	kg
Art. 1583-900	2 930 EUR	715	9 952	227
Art. 1583-901	2 480 EUR	715	9 952	227
1250 Liter		kg CO ₂ e	MJ	kg
Art. 1584-900	4 120 EUR	1193	16 618	379
Art. 1584-901	3 480 EUR	1193	16 618	375

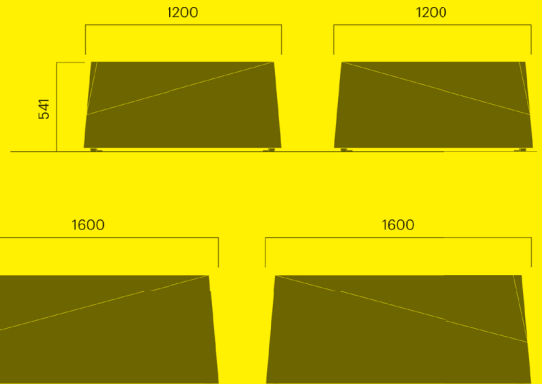

Boboli



Boboli Pflanzkasten

150 Liter		kg CO ₂ e	MJ	kg
Art. bob 065-070	880 EUR	-	-	45
Art. bob 065-070RAL	880 EUR	-	-	45

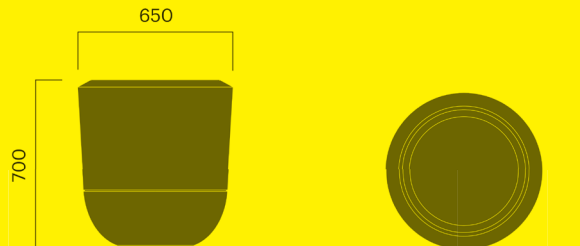

Boboli Pflanzkasten

170 Liter		kg CO ₂ e	MJ	kg
Art. bob 090-038	920 EUR	-	-	35

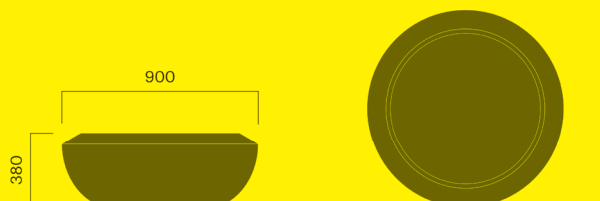

Boboli Pflanzkasten

380 Liter		kg CO₂e	MJ	kg
Art. bob 090-070	1 350 EUR	-	-	65

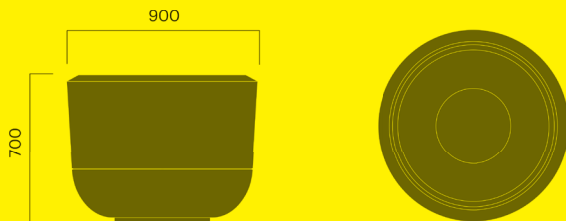

Boboli Pflanzkasten

500 Liter		kg CO₂e	MJ	kg
Art. bob 090-090	1 460 EUR	-	-	80
Art. bob 090-090RAL	1 460 EUR	-	-	80

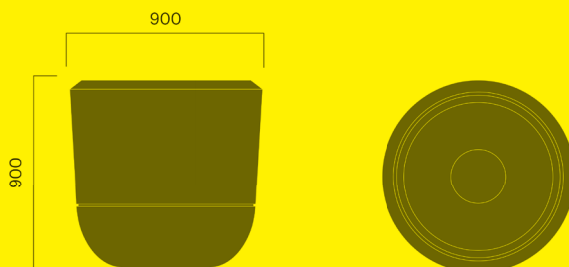

Boboli Pflanzkasten

560 Liter		kg CO₂e	MJ	kg
Art. bob 120-070	1 770 EUR	-	-	80

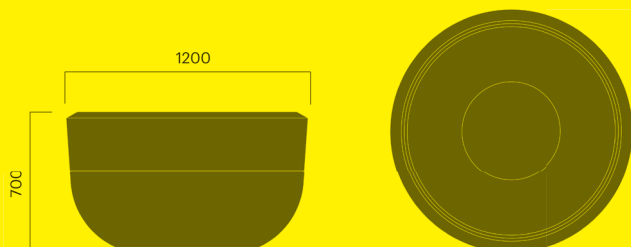

Boboli Pflanzkasten

760 Liter		kg CO ₂ e	MJ	kg
Art. bob 180-038	1 800 EUR	-	-	70

Bewässerungssystem auf Anfrage. Kann ohne Aufpreis mit Entwässerungslöchern geliefert werden.

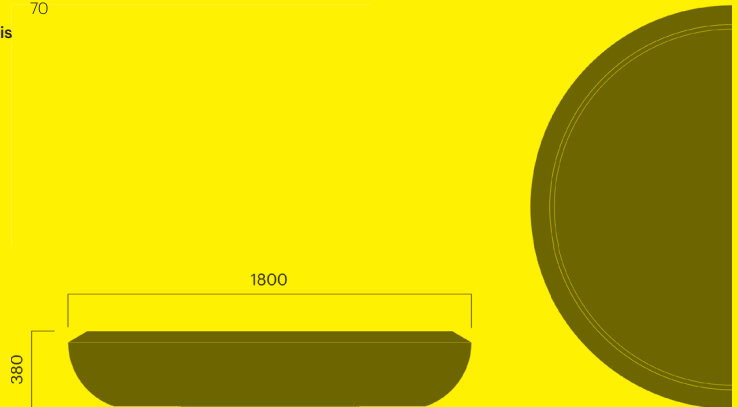

Boboli Pflanzkasten

760 Liter		kg CO ₂ e	MJ	kg
Art. bob 130-038	1 220 EUR	-	-	350

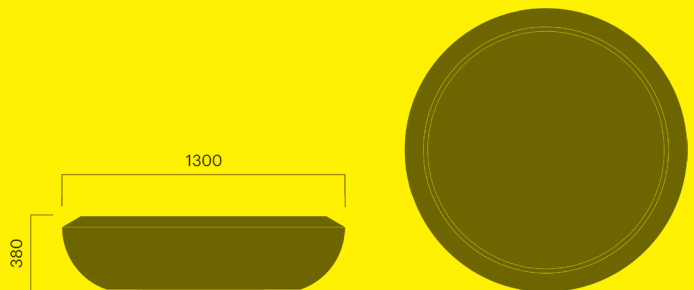

Bøy



Bøy Fahrradständer

für 2 Fahrräder		kg CO ₂ e	MJ	kg
Art. 388-900	310 EUR	37	512	12
Art. 388-901	250 EUR	37	512	12

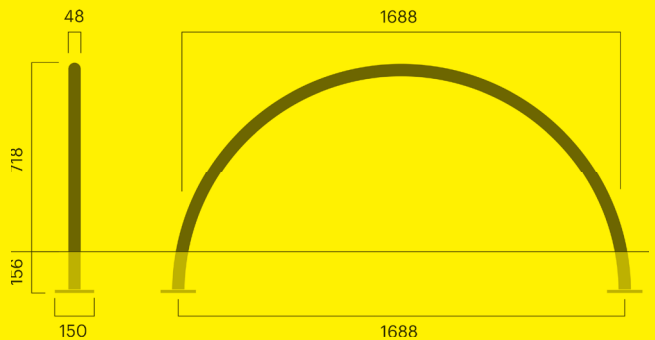



Briskeby Hockerbank

		kg CO ₂ e	MJ	kg
Art. 6006-900	1 450 EUR	139	2 252	61
Art. 6006-901	1 250 EUR	139	2 252	61
Art. 6006-960	2 900 EUR	139	2 252	58

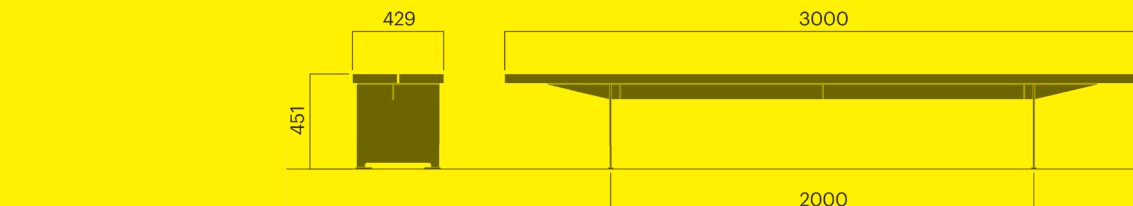

Briskeby Hockerbank

mit Armlehnen		kg CO ₂ e	MJ	kg
Art. 6007-900	1 680 EUR	139	2 252	64
Art. 6007-901	1 480 EUR	150	2 404	64
Art. 6007-960	3 280 EUR	150	2 404	64

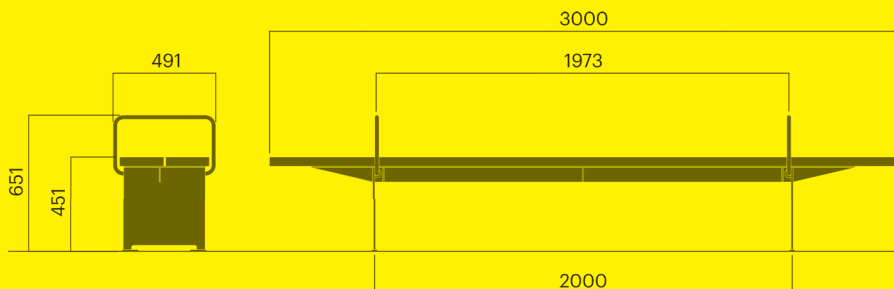

Briskeby Bank, kurz

		kg CO ₂ e	MJ	kg
Art. 6013-900	1 650 EUR	150	2 460	67
Art. 6013-901	1 450 EUR	150	2 460	67
Art. 6013-960	3 300 EUR	150	2 460	64

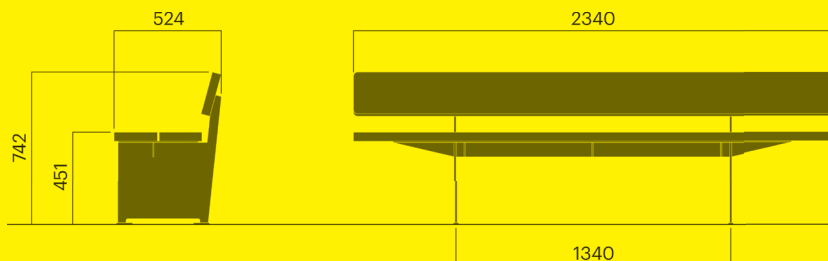

Briskeby Bank

ohne Armlehnen		kg CO ₂ e	MJ	kg
Art. 6016-900	1 750 EUR	163	2 737	78
Art. 6016-901	1 520 EUR	163	2 737	78
Art. 6016-960	3 980 EUR	163	2 737	78

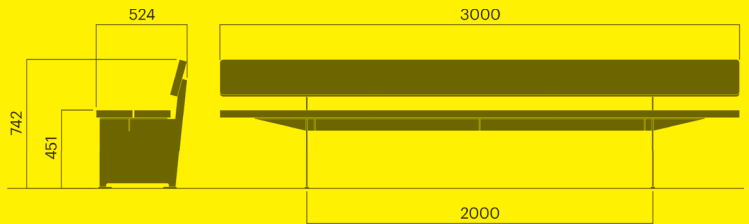

Briskeby Bank

mit Armlehnen		kg CO ₂ e	MJ	kg
Art. 6017-900	1 980 EUR	189	3 123	83
Art. 6017-901	1 780 EUR	189	3 123	83
Art. 6017-960	4 480 EUR	189	3 123	73

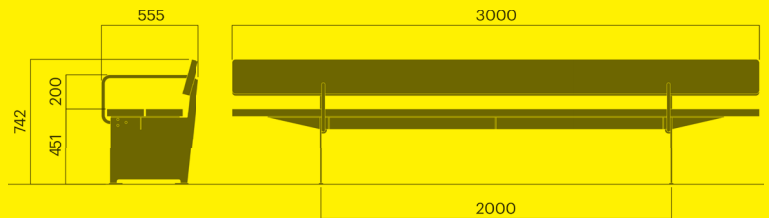

Buzz



Buzz Tisch-Bank-Kombination

Tischplatte und Sitzauflagen aus Hochdrucklaminat (HPL), optional mit grafischem Motiv (Aufpreis)

		kg CO ₂ e	MJ	kg
Art. 3316-900	2 870 EUR	149	2 337	70
Art. 3316-901	2 440 EUR	149	2 337	70

Tischplatte Stahl, Sitzauflagen Holz

		kg CO ₂ e	MJ	kg
Art. 3317-900	2 560 EUR	244	3 489	81
Art. 3317-901	1 980 EUR	244	3 489	81

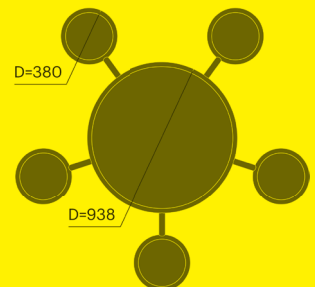
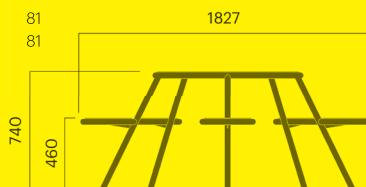

Buzz Tisch-Bank-Kombination

rollstuhlgerecht

Tischplatte und Sitzauflagen
aus Hochdrucklaminat (HPL),
optional mit grafischem Motiv
(Aufpreis)

Art. 3316-900H **2 560 EUR**

Art. 3316-901H **2 120 EUR**

Tischplatte Stahl, Sitzauflagen
Holz, rollstuhlgerecht

Art. 3317-900H **2 410 EUR**

Art. 3317-901H **1 810 EUR**

kg CO₂e MJ

kg

144 2 247 60

144 2 247 60

223 3 171 73

223 3 171 73

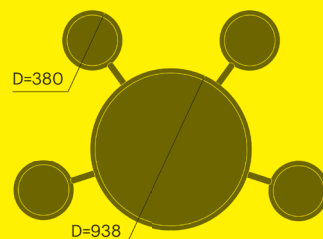

City



City Abfallbehälter

für Pfosten- oder Wandmontage

flacher Deckel

kg CO₂e MJ

kg

Art. 241-900 **850 EUR** 91 1 274 25

Art. 241-901 **720 EUR** 91 1 274 24

gewölbter Deckel

Art. 251-900 **1 000 EUR** 101 1 409 30

Art. 251-901 **870 EUR** 101 1 409 31

mit Aschenbecher, gewölbter
Deckel

Art. 259-900 **1 200 EUR** 102 1 428 29

Art. 259-901 **1 050 EUR** 102 1 428 38

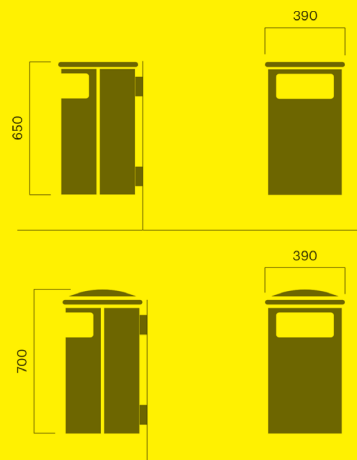

City Abfallbehälter, geteilter Einwurf

50 Liter

flacher Deckel

kg CO₂e MJ

kg

Art. 244-900 **890 EUR** 98 1 366 25

Art. 244-901 **590 EUR** 98 1 366 25

mit Aschenbecher, gewölbter
Deckel

Art. 254-900 **1 020 EUR** 99 1 387 28

Art. 254-901 **890 EUR** 99 1 387 28

mit Aschenbecher, gewölbter
Deckel

Art. 255-900 **1 200 EUR** 98 1 366 29

Art. 255-901 **870 EUR** 98 1 366 29

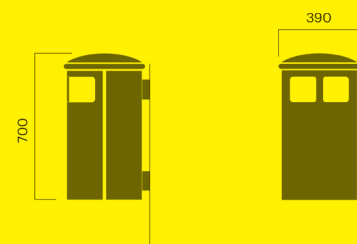

City Montagepfosten

Ø76, Verankerung A oder C		kg CO ₂ e	MJ	kg
Art. 292-900A	220 EUR	25	352	9
Art. 292-901A	190 EUR	25	352	8
Art. 292-900C	190 EUR	29	399	10
Art. 292-901C	160 EUR	29	399	8
Ø76/60				
Art. 293-900	220 EUR	25	344	11
Art. 293-901	190 EUR	25	344	11

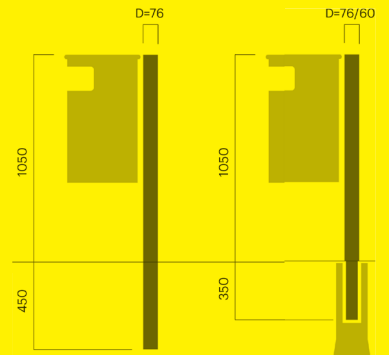

City Klemmsatz

für 4" Pfosten, Ø101		kg CO ₂ e	MJ	kg
Art. 290-900	120 EUR	7	94	3
Art. 290-901	90 EUR	7	94	3
für 5" Pfosten, Ø127				
Art. 291-900	120 EUR	7	99	2
Art. 291-901	90 EUR	7	99	2



City Abfallbehälter

70 Liter

flacher Deckel		kg CO ₂ e	MJ	kg
Art. 242-900	980 EUR	106	1 474	32
Art. 242-901	840 EUR	106	1 474	32
gewölbter Deckel				
Art. 252-900	1 360 EUR	115	1 605	35
Art. 252-901	1 220 EUR	115	1 605	35
mit Aschenbecher, gewölbter Deckel				
Art. 243-900	1 160 EUR	119	1 658	36
Art. 243-901	910 EUR	119	1 658	36

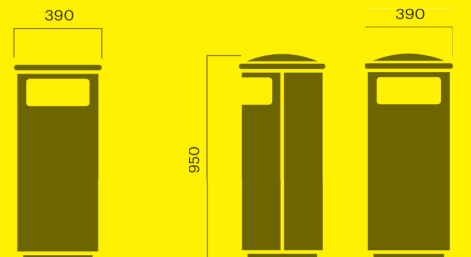

City Abfallbehälter

150 Liter

flacher Deckel		kg CO ₂ e	MJ	kg
Art. 247-900	1 140 EUR	139	1 931	49
Art. 247-901	990 EUR	139	1 931	49

gewölbter Deckel

Art. 257-900	1 340 EUR	132	1 920	53
Art. 257-901	1 190 EUR	132	1 920	54

mit Aschenbecher, gewölbter Deckel

Art. 261-900	1 540 EUR	132	1 920	54
Art. 261-901	1 390 EUR	132	1 920	59

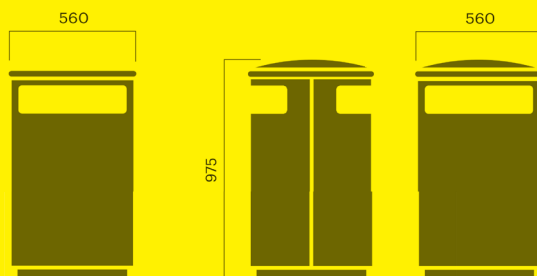

City Abfallbehälter , geteilter Einwurf

150 Liter

Standart		kg CO ₂ e	MJ	kg
Art. 277-900	1 340 EUR	159	2 214	54
Art. 277-901	1 190 EUR	159	2 214	53

mit Aschenbecher

Art. 278-900	1 580 EUR	164	2 290	55
Art. 278-901	1 250 EUR	164	2 290	53

mit Pfandsammler

Art. 279-900	1 220 EUR	178	2 477	58
Art. 279-901	1 070 EUR	178	2 477	53

mit Aschenbecher und Pfandsammler

Art. 280-900	1 580 EUR	183	2 552	59
Art. 280-901	1 430 EUR	183	2 552	59



City Abfallbehälter

180 Liter

flacher Deckel		kg CO ₂ e	MJ	kg
Art. 248-900	1 180 EUR	157	2 184	55
Art. 248-901	1 030 EUR	157	2 184	53

gewölbter Deckel

Art. 258-900	1 380 EUR	176	2 453	61
Art. 258-901	1 220 EUR	176	2 453	61

mit Aschenbecher, gewölbter Deckel

Art. 262-900	1 580 EUR	181	2 521	61
Art. 262-901	1 430 EUR	181	2 521	62

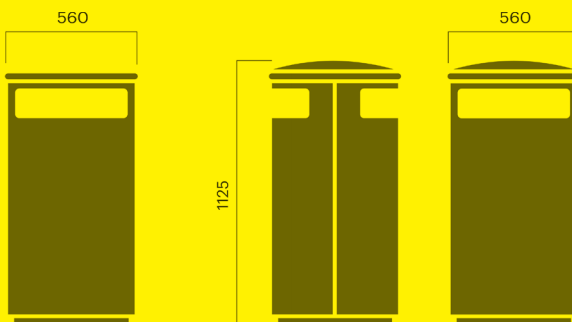

City Abfallbehälter, geteilter Einwurf

180 Liter

		kg CO ₂ e	MJ	kg
flacher Deckel				
Art. 276-900	1 220 EUR	177	2 472	55
Art. 276-901	790 EUR	177	2 472	55
gewölbter Deckel				
Art. 275-900	1 420 EUR	177	2 472	61
Art. 275-901	980 EUR	177	2 472	61
mit Aschenbecher, gewölbter Deckel				
Art. 274-900	1 620 EUR	182	2 535	61
Art. 274-901	1 470 EUR	182	2 535	55

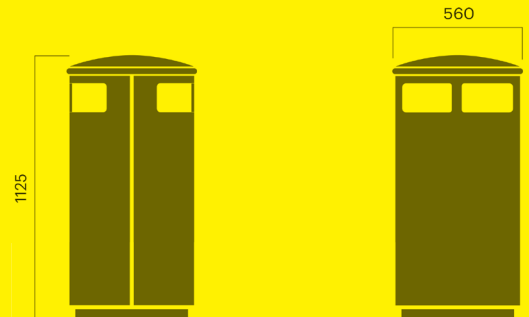

City Pfandbehälter

180 Liter

		kg CO ₂ e	MJ	kg
flacher Deckel				
Art. 270-900	1 640 EUR	194	2 704	57
Art. 270-901	1 450 EUR	194	2 704	57
gewölbter Deckel				
Art. 272-900	1 780 EUR	194	2 704	63
Art. 272-901	1 520 EUR	194	2 704	63
mit Aschenbecher, gewölbter Deckel				
Art. 271-900	1 960 EUR	194	2 704	65
Art. 271-901	1 820 EUR	194	2 704	65

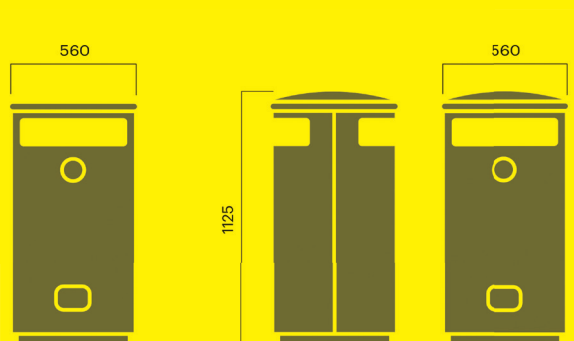

City Aschenbecher

für Wandbefestigung

		kg CO ₂ e	MJ	kg
Art. 265-900	350 EUR	18	253	5
Art. 265-901	330 EUR	18	253	5

zur Montage an Pfosten

Art. 266-900	360 EUR	20	286	6
Art. 266-901	350 EUR	20	286	6

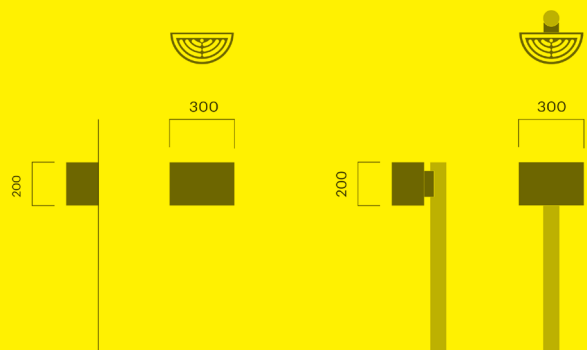

City Aschenbecher

17 Liter, gewölbter Deckel

Höhe: 630

		kg CO ₂ e	MJ	kg
Art. 263-900	880 EUR	121	1 346	28
Art. 263-901	780 EUR	121	1 346	37

Höhe: 930

Art. 264-900	980 EUR	152	1 766	45
Art. 264-901	880 EUR	152	1 766	45

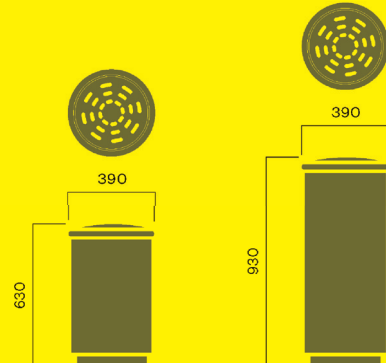

City Aschenbecher

60 Liter, flacher Deckel

		kg CO ₂ e	MJ	kg
Art. 267-900	940 EUR	82	1 190	32
Art. 267-901	850 EUR	82	1 190	32

120 Liter, flacher Deckel

Art. 268-900	1 070 EUR	109	1 601	28
Art. 268-901	980 EUR	109	1 601	35

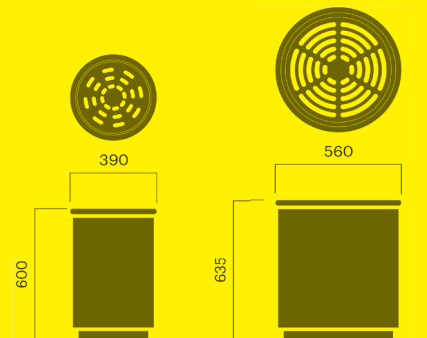

City Fahrradpoller

komplett mit Fundament

für 2 Fahrräder

		kg CO ₂ e	MJ	kg
Art. 286-800	480 EUR	82	1 270	20

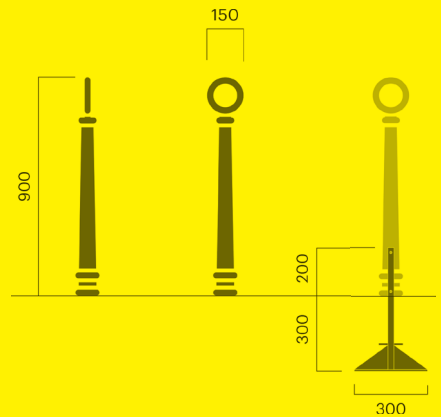



Coast Bank

Mietmodell auf Anfrage	kg CO ₂ e	MJ	kg
Art. 5506-530	-	-	-
Art. 5506-530	-	-	-

Sitzauflagen aus Holz

Art. 5506-900	2 120 EUR	193	2 973	75
Art. 5506-901	1 870 EUR	193	2 973	75

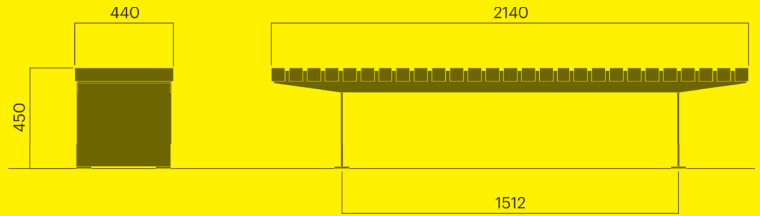

Code



Code Square Modulbank

Komplettes Basismodul, inkl. Sitzauflage und Front	kg CO ₂ e	MJ	kg	
Art. 2616-900	1 290 EUR	137	2 226	60
Art. 2616-901	1 140 EUR	137	2 226	59

Basismodul, ohne Holz

Art. 2617-900	660 EUR	100	1 393	32
Art. 2617-901	540 EUR	100	1 393	32

Sitzauflage aus Holz

Art. 2620-900	490 EUR	20	492	17
Art. 2620-901	470 EUR	20	492	17

Frontverblendung aus Holz

Art. 2624-900	330 EUR	17	349	6
Art. 2624-901	310 EUR	17	349	6

Armlehne, 1 Stück

Art. 2628-900	460 EUR	42	586	13
Art. 2628-901	420 EUR	42	586	13

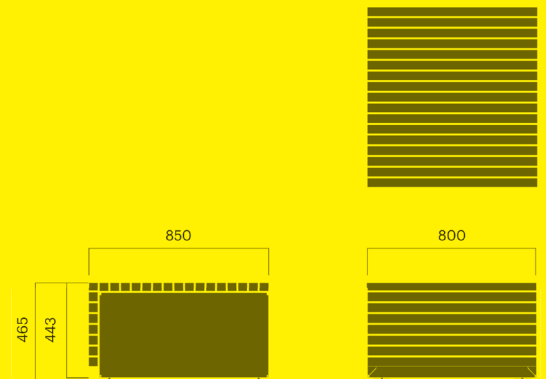

Code Square Pflanzkasten

230 Liter		kg CO ₂ e	MJ	kg
Art. 2640-900	1 230 EUR	182	2 530	68
Art. 2640-901	1 060 EUR	182	2 530	58
500 Liter		kg CO ₂ e	MJ	kg
Art. 2646-900	1 580 EUR	285	3 975	102
Art. 2646-901	1 380 EUR	285	3 975	92

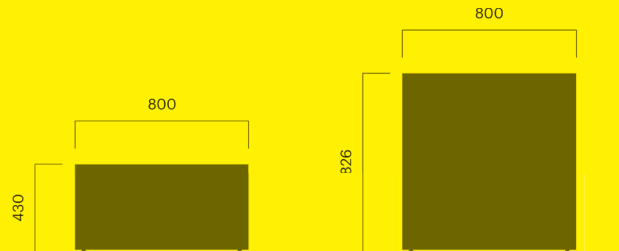

Corner



Corner

Maueraufsatz, lang		kg CO ₂ e	MJ	kg
Art. 4103-900MK	1 270 EUR	79	1 384	39
Art. 4103-901MK	1 170 EUR	79	1 384	39

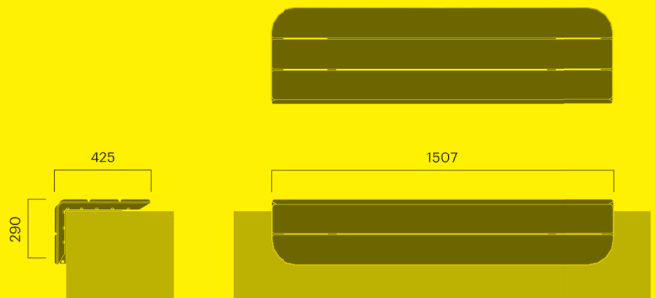

Corner

Maueraufsatz, 1-Sitzer		kg CO ₂ e	MJ	kg
Art. 4104-900MK	1 050 EUR	37	585	15
Art. 4104-901MK	950 EUR	37	585	15

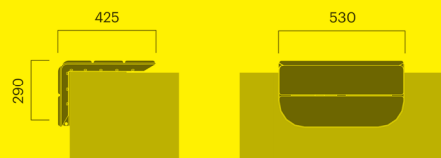

Cover



Cover Überdachung

		kg CO ₂ e	MJ	kg
mit Stahldach				
Art. 4701-900A	12 000 EUR	1945	27 166	618
Art. 4701-901A	10 500 EUR	1945	27 166	618
mit Glasdach				
Art. 4702-900A	13 000 EUR	1446	21 065	584
Art. 4702-901A	11 500 EUR	1446	21 065	584
mit Sedum-Matte				
Art. 4703-900A	13 500 EUR	1880	29 113	628
Art. 4703-901A	12 000 EUR	1880	29 113	628

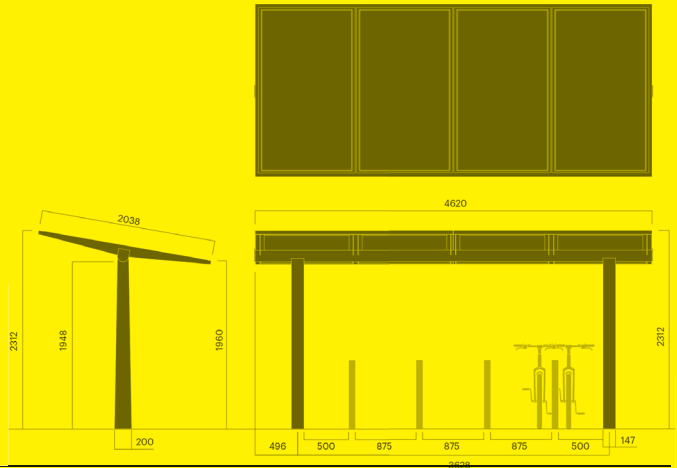

Cycle



Cycle Fahrradständer

		kg CO ₂ e	MJ	kg
zum Aufschrauben				
Art. 4886-900A	800 EUR	52	718	16
Art. 4886-901A	800 EUR	52	718	16
zum Einbetonieren				
Art. 4886-900C	800 EUR	47	657	15
Art. 4886-901C	800 EUR	47	657	16

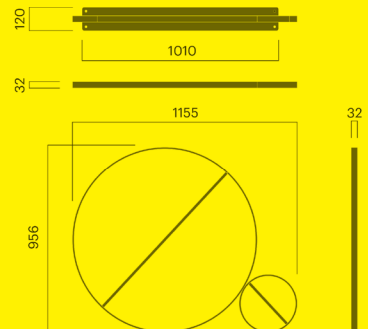

Dialog



Dialog Hockerbank

Kebony Clear		kg CO ₂ e	MJ	kg
Art. 1406-932	3 190 EUR	29	884	35
Eiche		kg CO ₂ e	MJ	kg
Art. 1406-942	3 190 EUR	21	1 115	35

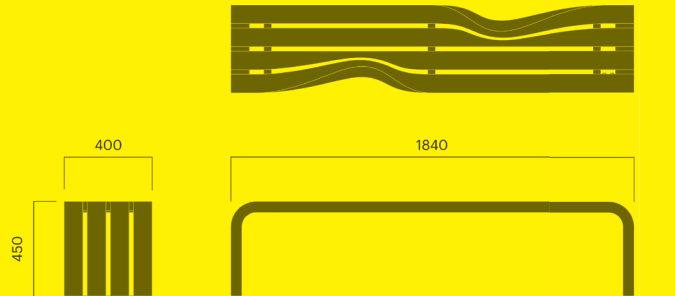

Dialog Abfallbehälter

100 Liter		kg CO ₂ e	MJ	kg
Art. 1442-900	1 480 EUR	178	2 444	84
Art. 1442-901	1 310 EUR	178	2 444	84

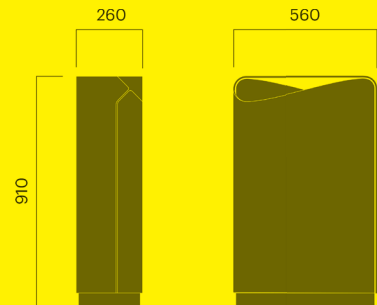

Dialog Mülltrennungssystem

3 x 55 Liter		kg CO ₂ e	MJ	kg
Art. 1448-900	2 410 EUR	282	3 932	89
Art. 1448-901	2 190 EUR	282	3 932	89
3 x 90 Liter		kg CO ₂ e	MJ	kg
Art. 1444-900	2 410 EUR	113	1 579	105
Art. 1444-901	2 190 EUR	113	1 579	105

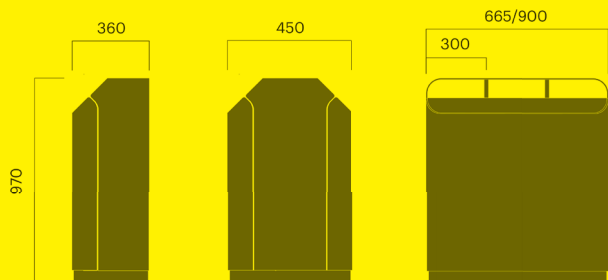



Edo Hockerbank, mit Mamortisch

Kebony, Eiche oder Esche		kg CO ₂ e	MJ	kg
Art. 4308-930	2 650 EUR	55	1 383	30
Art. 4308-940	2 650 EUR	18	1 076	30
Art. 4308-950	2 650 EUR	18	1 076	30

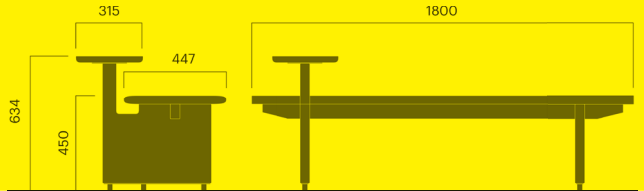

Edo Bank, nur Holz

Kebony, Eiche, Esche		kg CO ₂ e	MJ	kg
Art. 4316-930	3 190 EUR	57	1 427	40
Art. 4316-940	3 190 EUR	14	1 079	40
Art. 4316-950	3 190 EUR	14	1 079	40

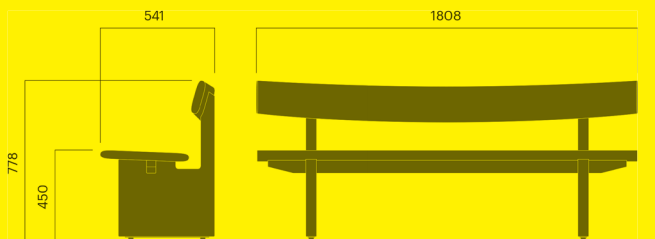

Edo Bank, mit Stahlwangen

Kebony, Eiche, Esche		kg CO ₂ e	MJ	kg
Art. 4315-930	2 580 EUR	155	2 834	69
Art. 4315-931	2 440 EUR	155	2 834	69

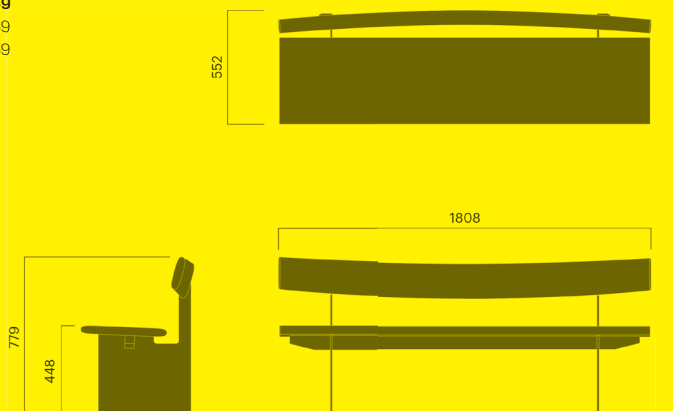



Folk Hockerbank

		kg CO ₂ e	MJ	kg
zum Einbetonieren				
Art. 4904-904C	1 020 EUR	50	983	25
zum Aufschrauben				
Art. 4904-904A	1 160 EUR	61	1168	27
freistehend				
Art. 4904-904	1 260 EUR	41	839	23

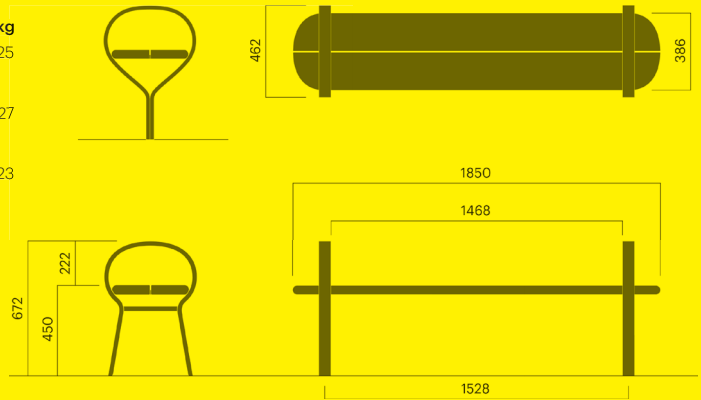

Folk Bank

		kg CO ₂ e	MJ	kg
zum Einbetonieren				
Art. 4914-904C	1 230 EUR	67	1347	33
zum Aufschrauben				
Art. 4914-904A	1 490 EUR	77	1521	38
freistehend				
Art. 4914-904	1 380 EUR	52	1095	30

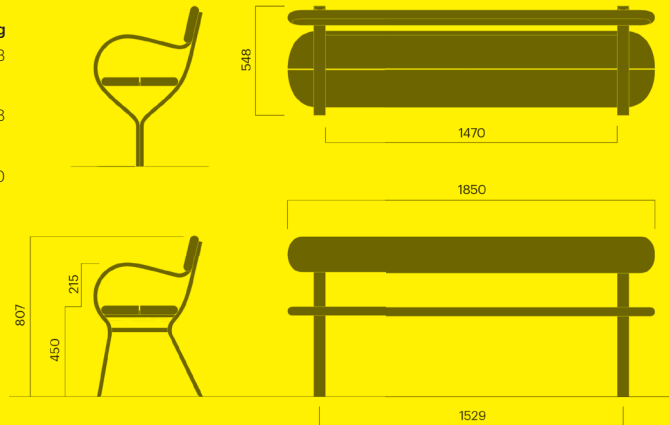

Folk Tisch

		kg CO ₂ e	MJ	kg
zum Einbetonieren				
Art. 4933-904C	1 200 EUR	96	1908	39
zum Aufschrauben				
Art. 4933-904A	1 380 EUR	108	2 104	39
freistehend				
Art. 4933-904	1 380 EUR	54	1 201	35

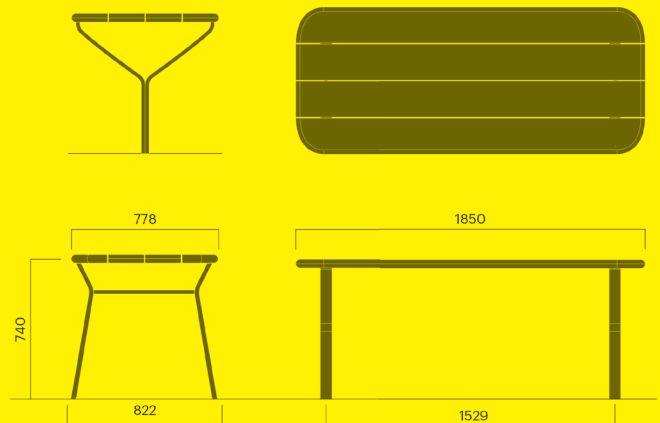

Folk Abfallbehälter

		kg CO ₂ e	MJ	kg
flacher Deckel, zum Aufschrauben				
Art. 4942-904C	1 260 EUR	134	1 944	30
flacher Deckel, zum Aufschrauben				
Art. 4942-904A	1 370 EUR	134	1 944	30
schräger Deckel, zum Aufschrauben				
Art. 4943-904C	1 280 EUR	106	1 568	29
schräger Deckel, zum Aufschrauben				
Art. 4943-904A	1 370 EUR	106	1 568	29

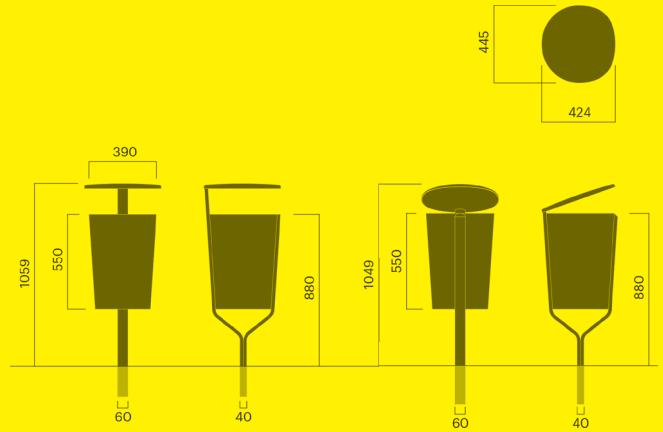

Folk Abfallbehälter

		kg CO ₂ e	MJ	kg
140 Liter				
Art. 4944-904	1 700 EUR	212	3 039	67

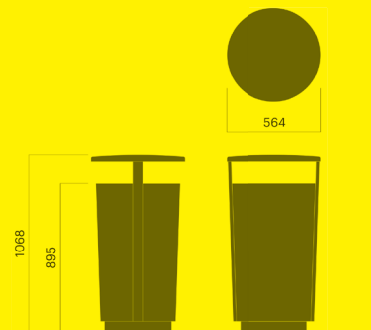

Folk Fahrradständer

		kg CO ₂ e	MJ	kg
kleine Öffnung, zum Einbetonieren				
Art. 4987-904C	280 EUR	22	371	7
kleine Öffnung, zum Aufschrauben				
Art. 4987-904A	360 EUR	28	469	8
große Öffnung, zum Aufschrauben				
Art. 4986-904A	370 EUR	28	464	9
große Öffnung, zum Einbetonieren				
Art. 4986-904C	290 EUR	22	371	8

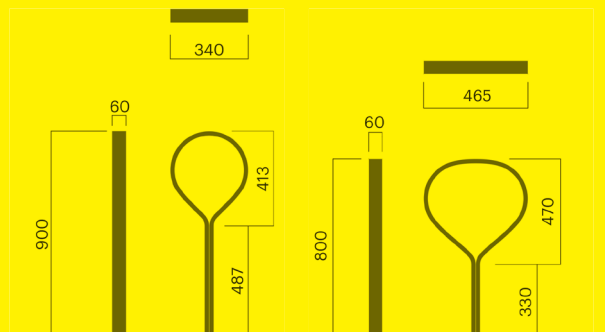



Forum Hockerbank

1 meter

		kg CO ₂ e	MJ	kg
Verankerung A oder C				
Art. 2502-900A	1 090 EUR	120	1 831	46
Art. 2502-901A	950 EUR	120	1 831	46
Art. 2502-900C	1 050 EUR	132	1 996	50
Art. 2502-901C	910 EUR	132	1 996	50
freistehend				
Art. 2502-900	1 310 EUR	150	2 249	56
Art. 2502-901	1 200 EUR	150	2 249	56

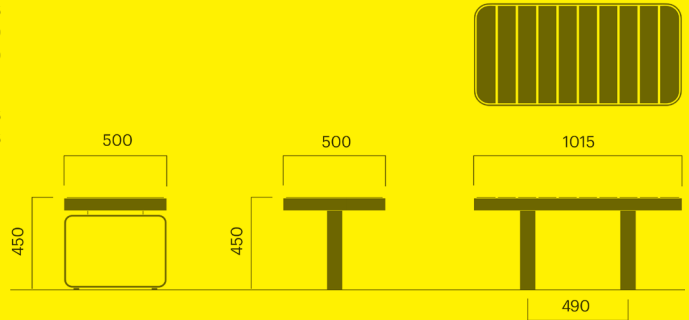

Forum Hockerbank

2 meter

		kg CO ₂ e	MJ	kg
Verankerung A oder C				
Art. 2503-900A	1 630 EUR	196	3 056	68
Art. 2503-901A	1 430 EUR	196	3 056	68
Art. 2503-900C	1 580 EUR	177	2 793	72
Art. 2503-901C	1 380 EUR	177	2 793	72
freistehend				
Art. 2503-900	1 950 EUR	196	3 056	78
Art. 2503-901	1 690 EUR	196	3 056	78

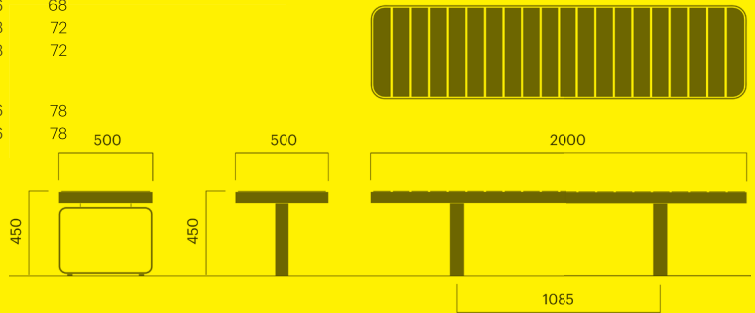

Forum Hockerbank

3 meter

		kg CO ₂ e	MJ	kg
Verankerung A oder C				
Art. 2504-900A	2 130 EUR	215	3 497	93
Art. 2504-901A	1 770 EUR	215	3 497	93
Art. 2504-900C	2 090 EUR	227	3 666	97
Art. 2504-901C	1 720 EUR	227	3 666	97
freistehend				
Art. 2504-900	2 410 EUR	246	3 929	103
Art. 2504-901	2 120 EUR	246	3 929	103

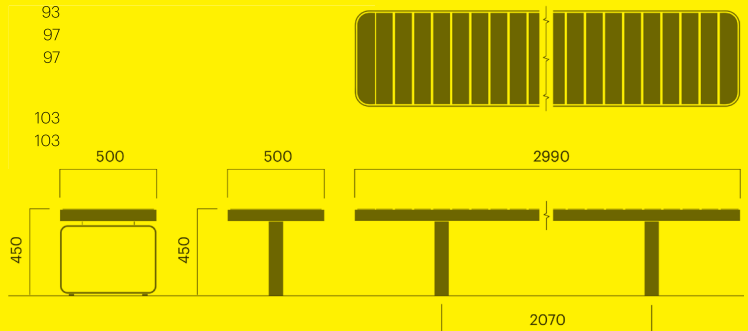

Forum Arm- und Rückenlehnen

		kg CO ₂ e	MJ	kg
Rückenlehne für 2 und 3 Meter Hockerbank				
Art. 2522-900	600 EUR	31	498	13
Art. 2522-901	470 EUR	31	498	12
Armlehne, 1 Stück				
Art. 2525-900	170 EUR	10	133	3
Art. 2525-901	140 EUR	10	133	3

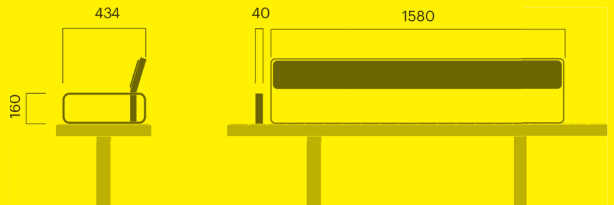

Forum Tisch

1 Meter

		kg CO ₂ e	MJ	kg
Verankerung A oder C				
Art. 2532-900A	1 120 EUR	135	2 041	51
Art. 2532-901A	980 EUR	135	2 041	51
Art. 2532-900C	1 060 EUR	146	2 200	55
Art. 2532-901C	920 EUR	146	2 200	55

freistehend

Art. 2532-900	1 370 EUR	173	2 571	63
Art. 2532-901	1 260 EUR	173	2 571	62

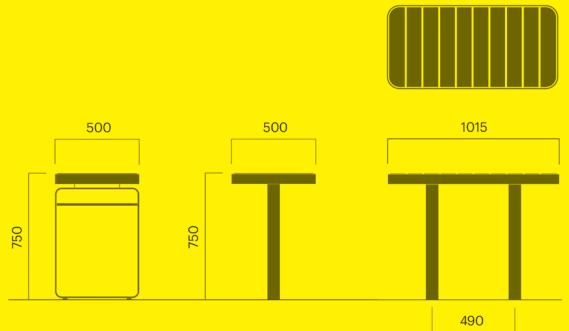

Forum Tisch

2 Meter

		kg CO ₂ e	MJ	kg
Verankerung A oder C				
Art. 2533-900A	1 800 EUR	180	2 841	73
Art. 2533-901A	1 490 EUR	180	2 841	73
Art. 2533-900C	1 730 EUR	204	3 174	77
Art. 2533-901C	1 460 EUR	204	3 174	77

freistehend

Art. 2533-900	2 120 EUR	221	3 413	86
Art. 2533-901	1 900 EUR	221	3 413	87

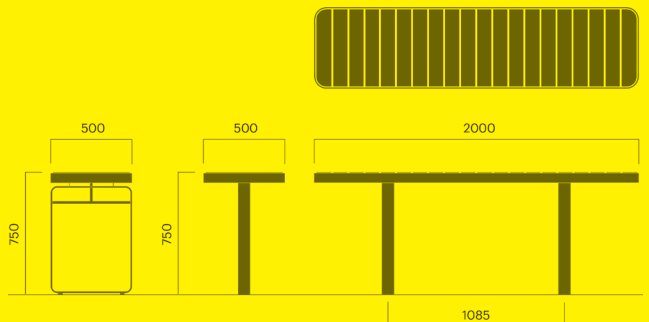

Forum Tisch

3 Meter

freistehend, B500		kg CO ₂ e	MJ	kg
Art. 2534-900	2 610 EUR	267	4 213	111
Art. 2534-901	2 230 EUR	267	4 213	112
freistehend, B750				
Art. 2536-900	3 190 EUR	387	6 135	120
Art. 2536-901	2 620 EUR	387	6 135	120

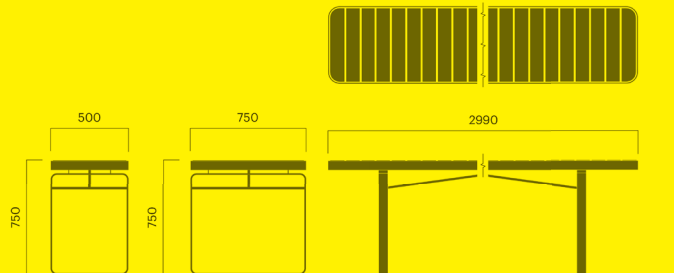

Forum Tisch

3 Meter

Verankerung A oder C, B500		kg CO ₂ e	MJ	kg
Art. 2534-900A	2 160 EUR	230	3 708	98
Art. 2534-901A	1 900 EUR	230	3 708	98
Art. 2534-900C	2 100 EUR	242	3 868	102
Art. 2534-901C	1 840 EUR	242	3 868	102
Verankerung A oder C, B750				
Art. 2536-900A	2 770 EUR	272	4 531	79
Art. 2536-901A	2 530 EUR	272	4 531	79
Art. 2536-900C	2 710 EUR	269	4 493	78
Art. 2536-901C	2 440 EUR	269	4 493	78

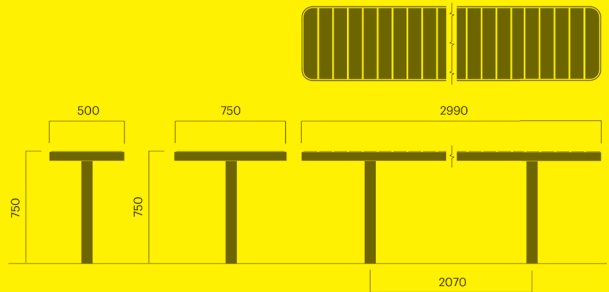

Forum Abfallbehälter

130 Liter

		kg CO ₂ e	MJ	kg
Art. 2542-900	1 810 EUR	180	2 475	85
Art. 2542-901	1 520 EUR	180	2 475	85
Art. 2543-900	1 810 EUR	183	2 521	86
Art. 2543-901	1 520 EUR	183	2 521	86
Art. 2544-900	1 810 EUR	174	2 394	85
Art. 2544-901	1 520 EUR	174	2 394	85
Art. 2545-900	1 810 EUR	175	2 404	84
Art. 2545-901	1 520 EUR	175	2 404	84
mit seitlichem Einwurf				
Art. 2546-900	1 810 EUR	203	2 802	94
Art. 2546-901	1 520 EUR	203	2 802	94

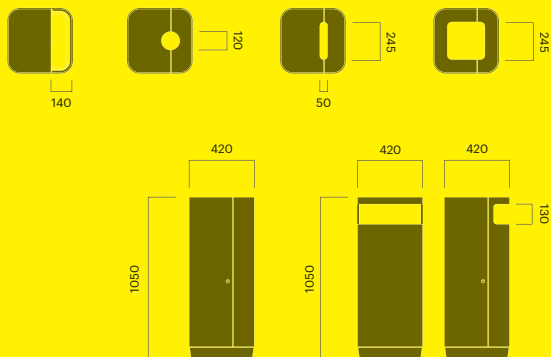

Forum Fahrradständer

Verankerung A oder C

		kg CO ₂ e	MJ	kg
schmal				
Art. 2584-904A	370 EUR	18	309	10
Art. 2584-904C	340 EUR	21	361	5
breit				
Art. 2586-904A	490 EUR	28	464	9
Art. 2586-904C	370 EUR	21	361	13

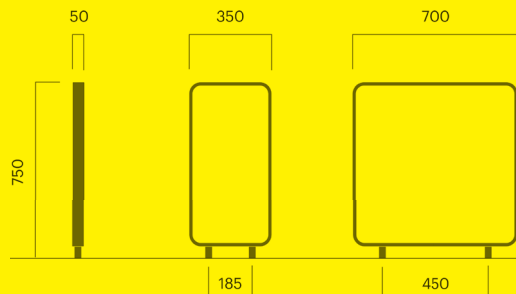

Hill



Hill Abfallbehälter

		kg CO ₂ e	MJ	kg
2 x 70 Liter				
zur Mülltrennung				
Art. 6342-900	1 650 EUR	203	2 828	64
Art. 6342-901	1 450 EUR	203	2 828	63
140 Liter				
Art. 6344-900	1 560 EUR	200	2 793	64
Art. 6344-901	1 360 EUR	200	2 793	63

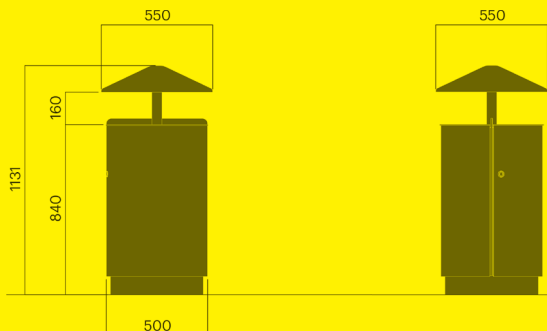

Hvilan



Hvilan Hockerbank

freistehend		kg CO ₂ e	MJ	kg
Art. 106-900	850 EUR	107	1 680	44
Art. 106-901	730 EUR	107	1 680	43

Zum Einbetonieren		kg CO ₂ e	MJ	kg
Art. 101-901	50 EUR	5	71	2

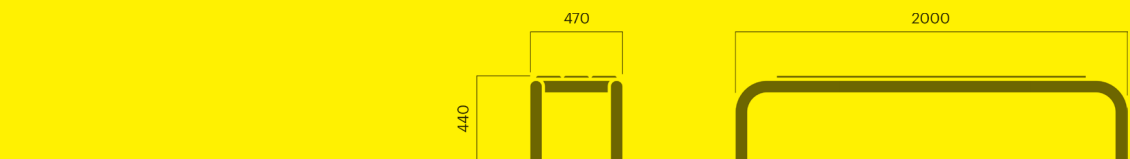

Hvilan Bank

freistehend		kg CO ₂ e	MJ	kg
Art. 116-900	1 380 EUR	140	2 284	59
Art. 116-901	1 080 EUR	140	2 284	59

Zum Einbetonieren		kg CO ₂ e	MJ	kg
Art. 101-901	50 EUR	5	71	2

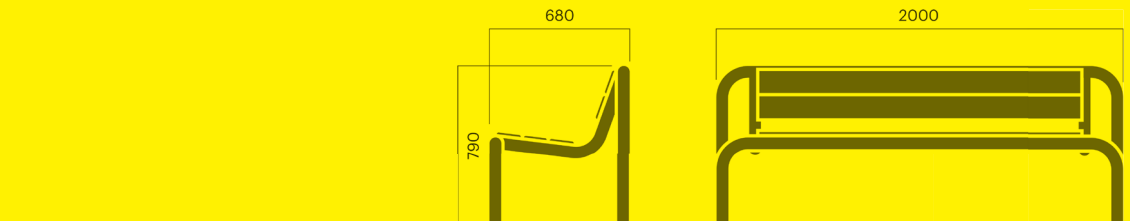

Hvilan Tisch

freistehend		kg CO ₂ e	MJ	kg
Art. 133-900	1 140 EUR	134	2 194	59
Art. 133-901	970 EUR	134	2 194	59

Zum Einbetonieren		kg CO ₂ e	MJ	kg
Art. 101-901	50 EUR	5	71	2

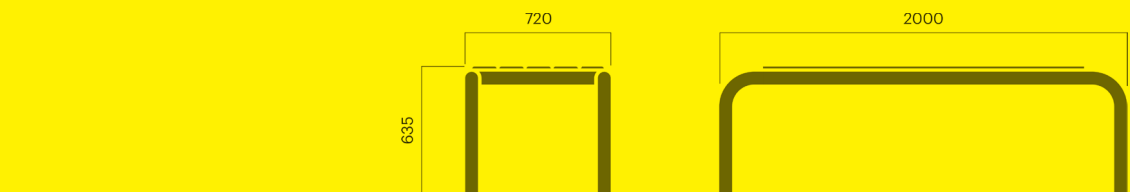

Hvilan Tischbank

		kg CO ₂ e	MJ	kg
Art. 122-900	1 850 EUR	161	2 868	69
Art. 122-901	1 650 EUR	161	2 868	69

rollstuhlgerecht

Art. 122-900HC	1 950 EUR	140	2 754	76
Art. 122-901HC	1 690 EUR	140	2 754	76

Bodenverankerung empfohlen

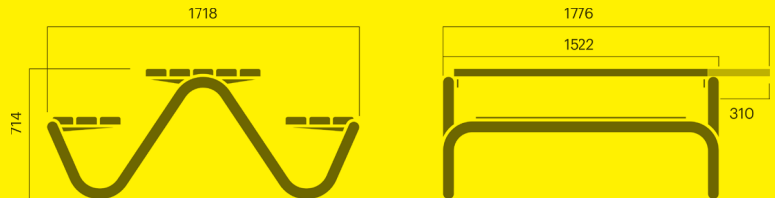

Hvilan Baumschutz

Ø900

		kg CO ₂ e	MJ	kg
Art. 153-900	880 EUR	129	1 797	43
Art. 153-901	680 EUR	129	1 797	43

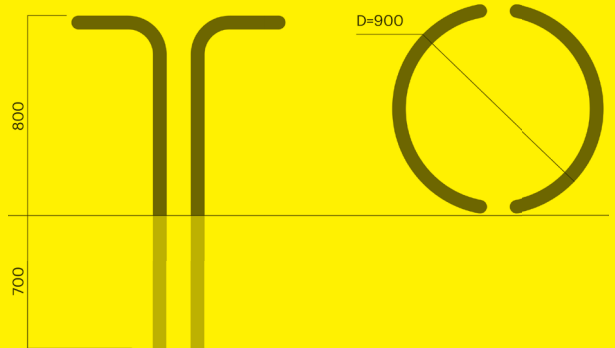

Hvilan Absperropoller

zum Aufschrauben		kg CO ₂ e	MJ	kg
Art. 185-900A	1 160 EUR	154	2 149	80
Art. 185-901A	1 060 EUR	154	2 149	80

zum Einbetonieren

Art. 185-900C	850 EUR	154	2 149	62
Art. 185-901C	680 EUR	154	2 149	62

demontierbar

Art. 185-900D	1 160 EUR	157	2 191	58
Art. 185-901D	1 060 EUR	157	2 191	58

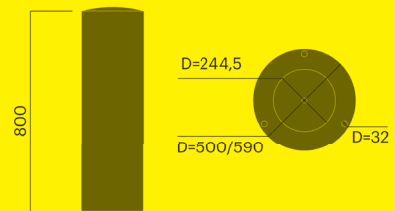

bei fachgerechtem Einbau stoppen die Absperropoller A und C, 3,5 Tonnen bei 30 km/h



Kong Cube

freistehend		kg CO ₂ e	MJ	kg
Art. 4010-900	1340 EUR	74	1336	38
Art. 4010-901	1160 EUR	74	1336	38
zum Einbetonieren				
Art. 4010-900C	1380 EUR	88	1529	43
Art. 4010-901C	1200 EUR	88	1529	43

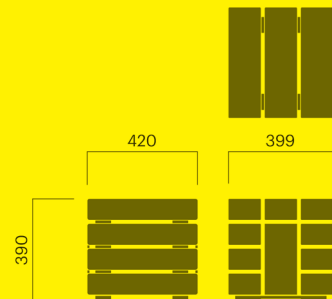

Kong Hockerbank

Verankerung A oder C		kg CO ₂ e	MJ	kg
Art. 4003-900A	1840 EUR	166	3289	102
Art. 4003-901A	1580 EUR	166	3289	102
Art. 4003-900C	1900 EUR	203	3797	114
Art. 4003-901C	1630 EUR	203	3797	114

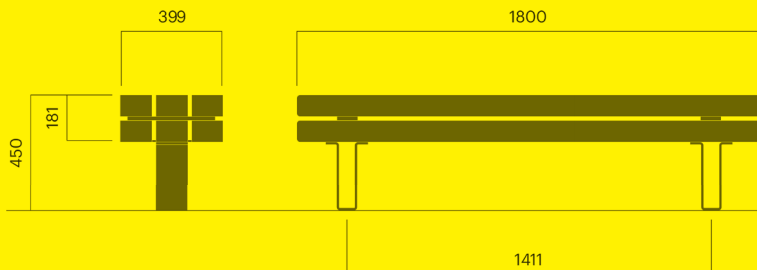

Kong Rückenlehne, für Hockerbank

		kg CO ₂ e	MJ	kg
Art. 4021-900	830 EUR	50	888	25
Art. 4021-901	770 EUR	50	888	25

Armlehne, 1 Stück

		kg CO ₂ e	MJ	kg
Art. 4025-900	210 EUR	16	229	5
Art. 4025-901	190 EUR	16	229	5

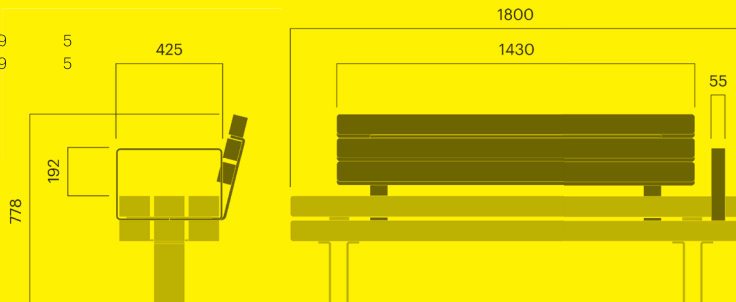

Kong Liegebank

Verankerung A oder C		kg CO ₂ e	MJ	kg
Art. 4066-900A	4 260 EUR	335	5 662	163
Art. 4066-901A	4 020 EUR	335	5 662	163
Art. 4066-900C	4 260 EUR	407	6 661	182
Art. 4066-901C	4 020 EUR	407	6 661	182

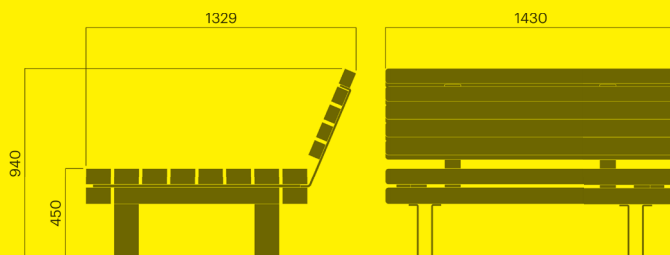

Kong Tisch

Verankerung A oder C		kg CO ₂ e	MJ	kg
Art. 4033-900A	1 980 EUR	340	5 128	125
Art. 4033-901A	1 770 EUR	340	5 128	125
Art. 4033-900C	2 100 EUR	396	5 898	144
Art. 4033-901C	1 880 EUR	396	5 898	144

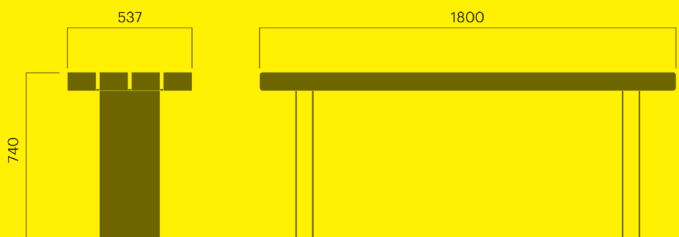

Kyoto



Kyoto Hockerbank

		kg CO ₂ e	MJ	kg
Art. 2206-004	1 800 EUR	39	1 399	165

Armlehnsenst

Art. 2226-900	420 EUR	16	221	5
Art. 2226-901	360 EUR	16	221	5

sollte mit dem Untergrund verschraubt werden

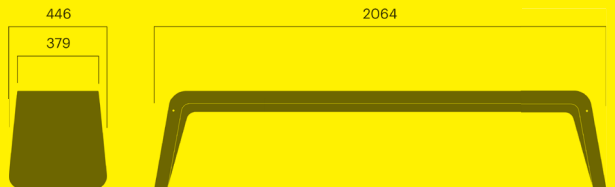

Kyoto Bank

		kg CO ₂ e	MJ	kg
Art. 2216-004	2 550 EUR	72	2 586	305

Armlehnsenst

Art. 2225-900	420 EUR	16	221	19
Art. 2225-901	360 EUR	16	221	5

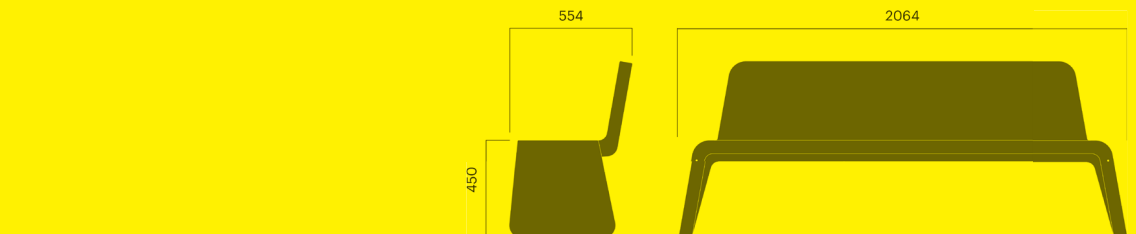

Kyoto Tisch

		kg CO ₂ e	MJ	kg
Art. 2236-004	3 050 EUR	105	3 773	445

sollte mit dem Untergrund verschraubt werden

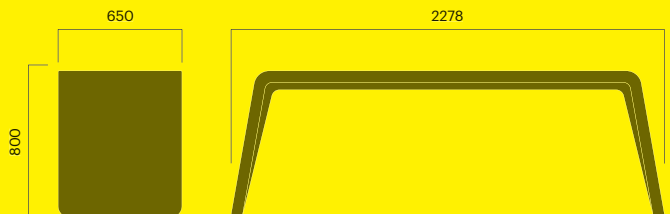

Move



Move Hockerbank

		kg CO ₂ e	MJ	kg
Art. 3106-900	1 980 EUR	215	3 375	87
Art. 3106-901	1 810 EUR	215	3 375	87

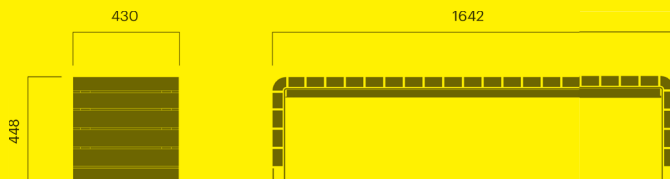

Munch



Munch Bistrostuhl

stapelbar		kg CO ₂ e	MJ	kg
Art. 5113-900	390 EUR	36	497	11
Art. 5113-901	320 EUR	36	497	11

Sitzauflagen auf Anfrage

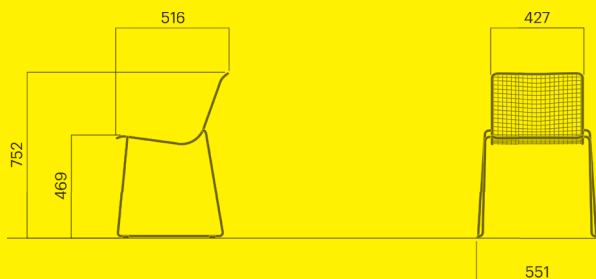

Munch Lounge Stuhl

		kg CO ₂ e	MJ	kg
Art. 5166-900	980 EUR	73	1 015	23
Art. 5166-901	860 EUR	73	1 015	23

Sitzauflagen auf Anfrage

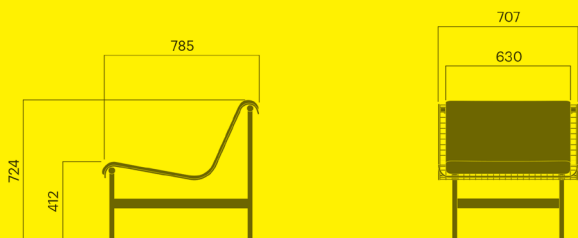
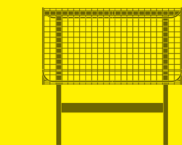

Munch Lounge Stuhl

mit Armlehnen

		kg CO ₂ e	MJ	kg
Art. 5167-900	1 280 EUR	86	1 205	32
Art. 5167-901	1 050 EUR	86	1 205	32

Sitzauflagen auf Anfrage

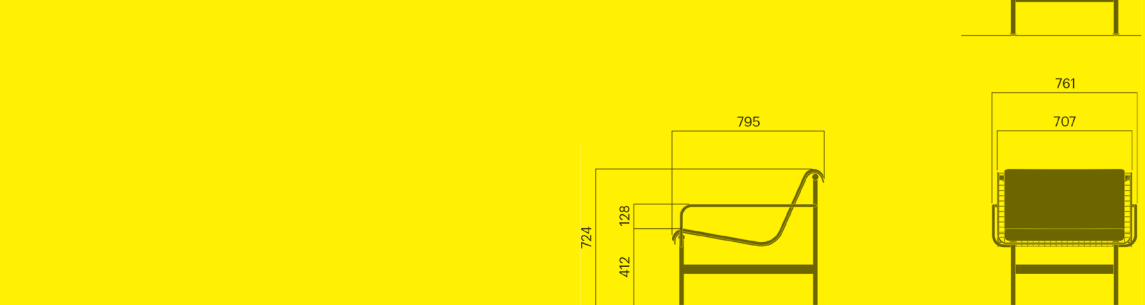

Munch Hockerbank

3-Sitzer

		kg CO ₂ e	MJ	kg
Art. 5106-900	1 080 EUR	110	1 539	35
Art. 5106-901	920 EUR	110	1 539	35

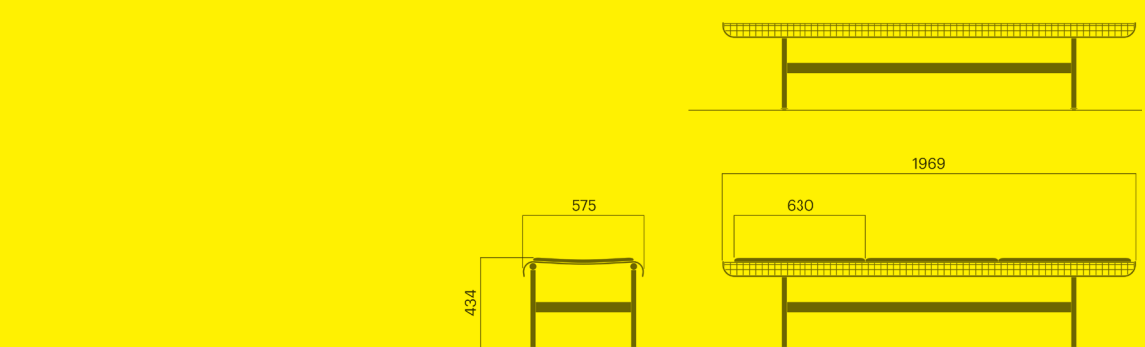

Munch Bank

3-Sitzer

		kg CO ₂ e	MJ	kg
Art. 5116-901	1 240 EUR	142	1 976	45
Art. 5116-900	1 360 EUR	142	1 976	45

Sitzauflagen auf Anfrage

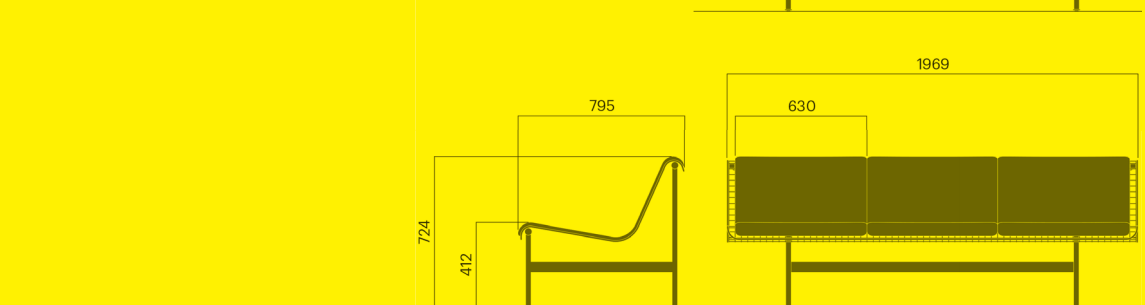

Munch Bank

3-Sitzer, mit Armlehnen

		kg CO ₂ e	MJ	kg
Art. 5117-900	1 660 EUR	153	2 136	49
Art. 5117-901	1 420 EUR	153	2 136	49

Sitzauflagen auf Anfrage

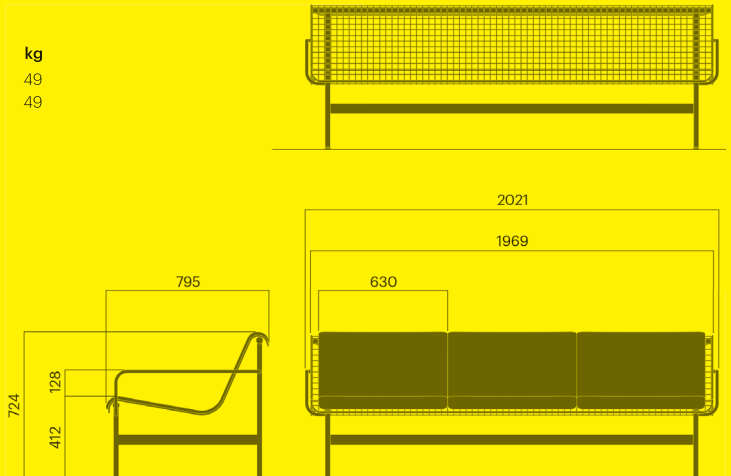

Munch Bistrotisch

rund

		kg CO ₂ e	MJ	kg
Art. 5132-900	520 EUR	113	1 577	31
Art. 5132-901	450 EUR	113	1 577	31

quadratisch

Art. 5134-900	560 EUR	113	1 577	37
Art. 5134-901	480 EUR	113	1 577	37

Sitzauflagen auf Anfrage

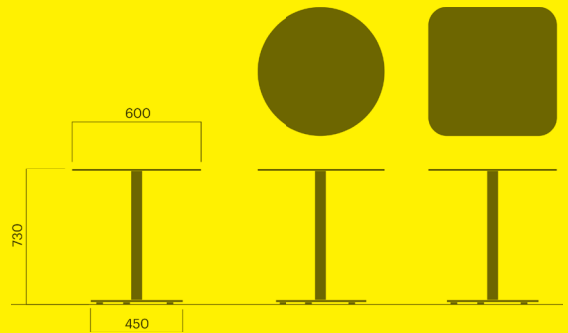

Munch Stahltisch

rund, hoch

		kg CO ₂ e	MJ	kg
Art. 5137-900	550 EUR	100	1 394	32
Art. 5137-901	470 EUR	100	1 394	32

quadratisch, hoch

Art. 5138-900	580 EUR	115	1 595	38
Art. 5138-901	510 EUR	115	1 595	38

rund, niedrig

Art. 5130-900	500 EUR	96	1 340	31
Art. 5130-901	430 EUR	96	1 340	31

quadratisch, niedrig

Art. 5131-900	540 EUR	112	1 556	37
Art. 5131-901	460 EUR	112	1 556	37

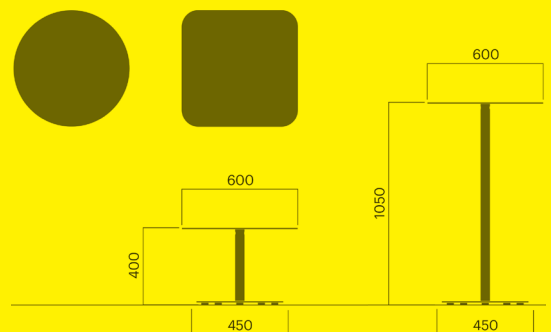



Parc Stuhl

		kg CO ₂ e	MJ	kg
Art. 2318-900	1090 EUR	48	936	19
Art. 2318-901	960 EUR	48	936	19

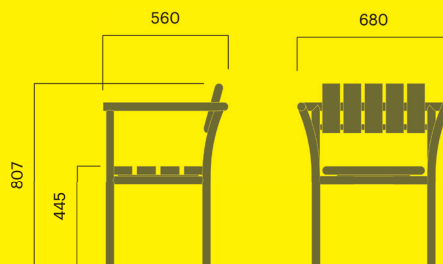

Parc Bank

		kg CO ₂ e	MJ	kg
Art. 2317-900	1570 EUR	77	1594	49
Art. 2317-901	1430 EUR	77	1594	49

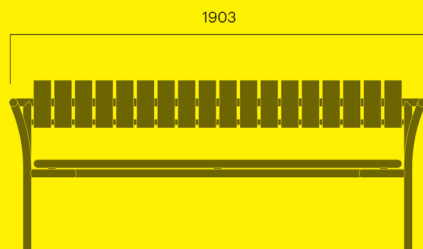

Parc Tisch

		kg CO ₂ e	MJ	kg
Art. 2336-900	1250 EUR	42	817	35
Art. 2336-901	1180 EUR	42	817	35

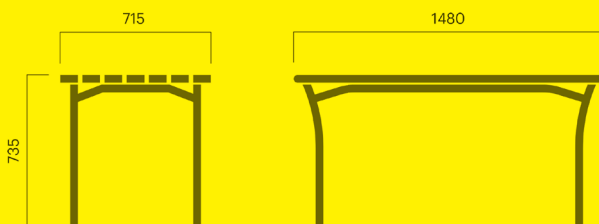

Parklet 2.0



Parklet Basismodell

		kg CO ₂ e	MJ	kg
Art. 4470-900	9 420 EUR	1907	30 345	786
Art. 4470-901	8 990 EUR	1907	30 345	786

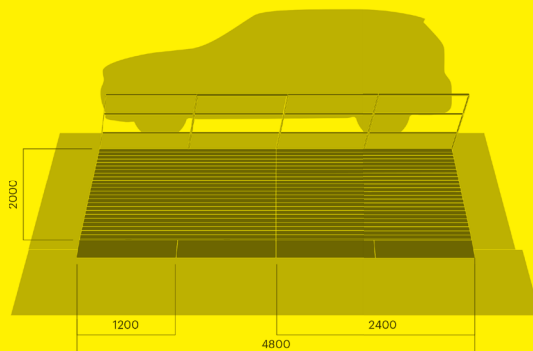

Parklet Hygge

		kg CO ₂ e	MJ	kg
Art. 4473-900	14 450 EUR	2445	39 355	1060
Art. 4473-901	13 910 EUR	2445	39 355	1039

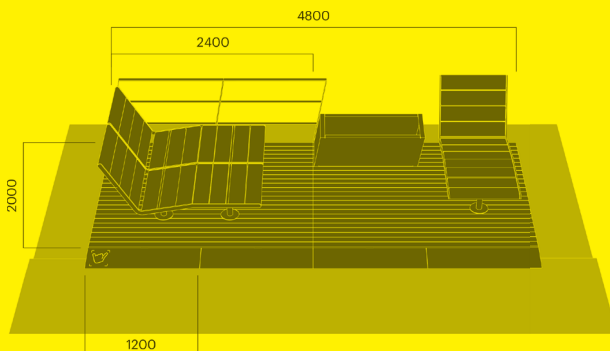

Parklet Portal

		kg CO ₂ e	MJ	kg
Art. 4472-900	15 520 EUR	3071	46 965	1361
Art. 4472-901	14 980 EUR	3071	46 965	1182

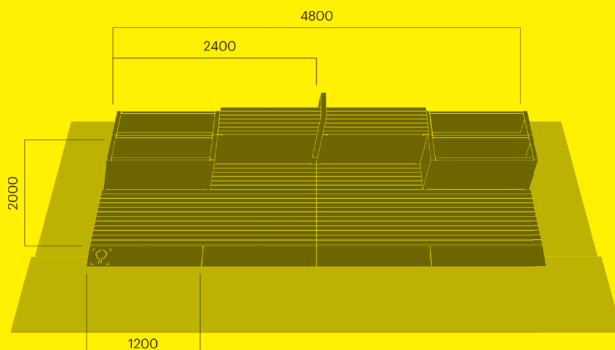

Parklet Wald

		kg CO ₂ e	MJ	kg
Art. 4474-900	16 050 EUR	3907	55 326	1233
Art. 4474-901	14 980 EUR	3907	55 326	1236

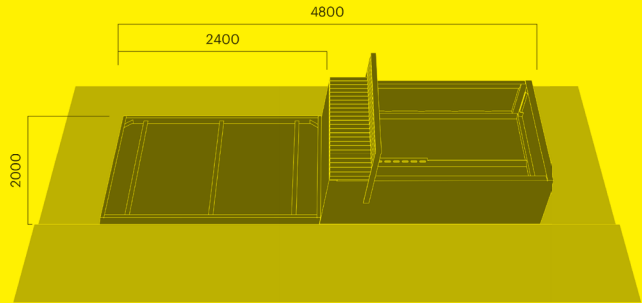

Parklet Café

		kg CO ₂ e	MJ	kg
Art. 4471-900	20 330 EUR	3566	52 678	1393
Art. 4471-901	18 730 EUR	3566	52 678	1599

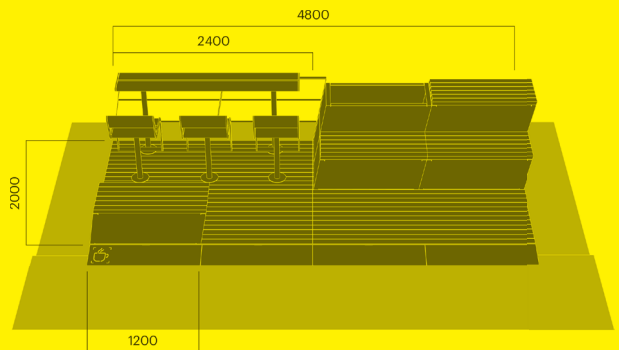

Parklet Boden und Zaun

Boden mit verstellbaren Füßen		kg CO ₂ e	MJ	kg
Art. 4401-901	3 160 EUR	708	11 716	318
Zaunlänge 1200 mm				
Art. 4454-900	470 EUR	44	610	14
Art. 4454-901	360 EUR	44	610	14

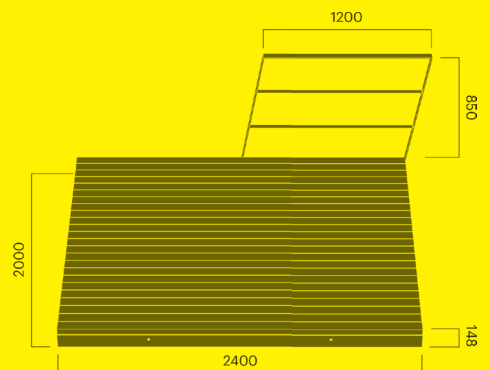

Parklet Übergangsplatten

ohne Symbol		kg CO ₂ e	MJ	kg
Art. 4440-901	390 EUR	72	994	24
mit Symbol				
Art. 4441-901	390 EUR	67	918	22
Art. 4442-901	390 EUR	67	923	22
Art. 4443-901	390 EUR	67	918	22
Art. 4444-901	390 EUR	67	923	22
Art. 4445-901	390 EUR	67	923	22

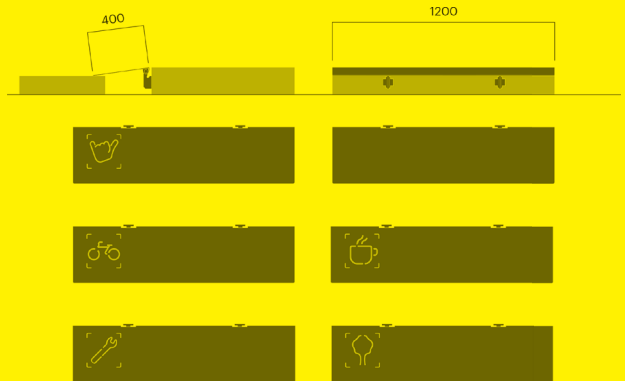

Parklet Fahrrad

3 Fahrradparker für 6 Fahrräder		kg CO ₂ e	MJ	kg
Art. 4475-900	4 500 EUR	1273	17 912	404
6 Fahrradparker für 12 Fahrräder				
Art. 4476-900	9 000 EUR	3242	45 515	809

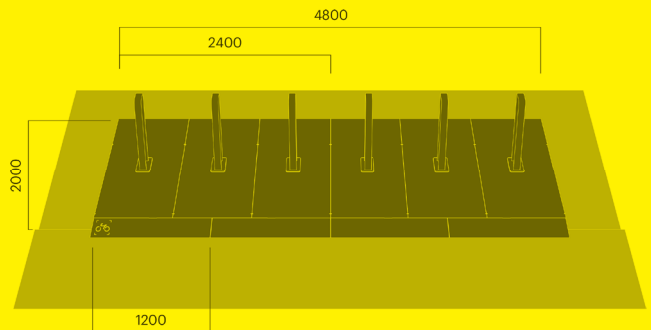

Parklet Werkstatt

		kg CO ₂ e	MJ	kg
Art. 4477-900	9 200 EUR	1273	17 912	511

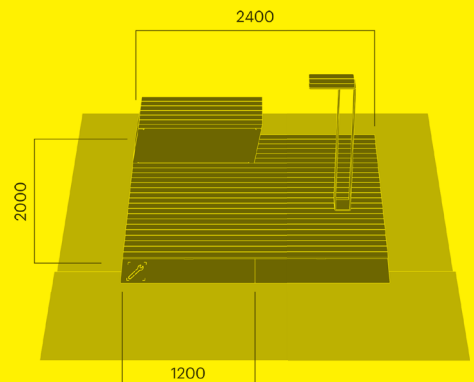

Parklet Sitzmodul

		kg CO ₂ e	MJ	kg
Art. 4406-900	1 440 EUR	216	3 243	79
Art. 4406-901	1 270 EUR	216	3 243	79

Sitzmodul mit Armlehne (1 Stück)

Art. 4407-900	1 580 EUR	229	3 422	115
Art. 4407-901	1 430 EUR	229	3 422	115

Basismodul, ohne Holz

Art. 4403-900	950 EUR	189	2 630	60
Art. 4403-901	830 EUR	189	2 630	60

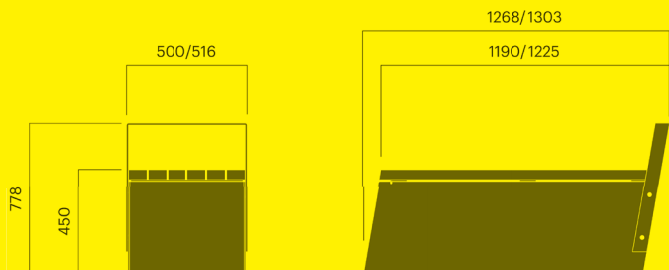

Parklet Pflanzkasten klein

mit Überlaufschutz und Drainagelöchern

		kg CO ₂ e	MJ	kg
Art. 4488-900	1 160 EUR	227	3 161	72
Art. 4488-901	1 050 EUR	227	3 161	72

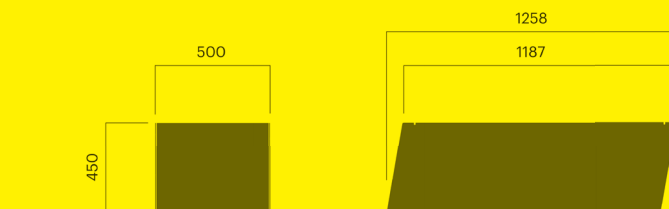

Parklet Pflanzkasten groß

niedrig		kg CO ₂ e	MJ	kg
Art. 4486-901	4 390 EUR	1210	16 876	383

hoch		kg CO ₂ e	MJ	kg
Art. 4480-900	9 100 EUR	2070	28 901	734
Art. 4480-901	8 350 EUR	2070	28 901	734

Sitzauflage

Art. 4420-900MK	1 520 EUR	176	2 848	75
Art. 4420-901MK	1 410 EUR	176	2 848	76

Rückenlehne

Art. 4421-900	1 160 EUR	101	1 607	42
Art. 4421-901	1 040 EUR	101	1 607	42

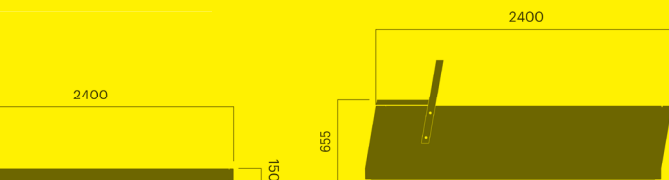



Plinth Hockerbank, kurz

		kg CO ₂ e	MJ	kg
H250, Verankerung A oder C				
Art. 5603-900A	790 EUR	63	1 011	34
Art. 5603-901A	680 EUR	63	1 011	34
Art. 5603-900c	800 EUR	126	1 887	34
Art. 5603-901c	700 EUR	126	1 887	34
H450, Verankerung A oder C				
Art. 5604-900A	1 020 EUR	112	1 690	52
Art. 5604-901A	880 EUR	112	1 690	49
Art. 5604-900C	1 020 EUR	167	2 459	71
Art. 5604-901C	880 EUR	167	2 459	34
H740, Verankerung A oder C				
Art. 5605-900A	1 270 EUR	162	2 393	58
Art. 5605-901A	1 100 EUR	162	2 393	58
Art. 5605-900C	1 270 EUR	227	3 294	58
Art. 5605-901C	1 100 EUR	227	3 294	58

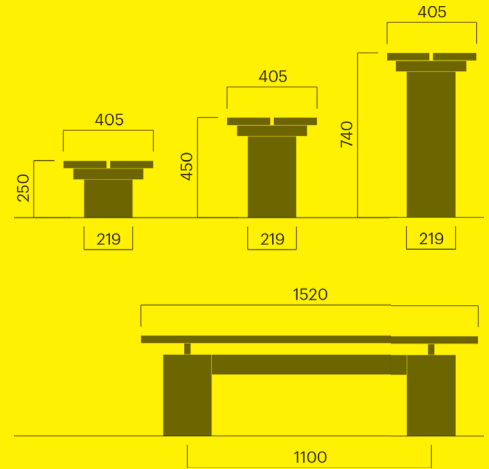

Plinth Hockerbank, lang

		kg CO ₂ e	MJ	kg
H250, Verankerung A oder C				
Art. 5606-900A	1 270 EUR	91	1 504	50
Art. 5606-901A	1 130 EUR	91	1 504	50
Art. 5606-900C	1 270 EUR	188	2 860	50
Art. 5606-901C	1 130 EUR	188	2 860	50
H450, Verankerung A oder C				
Art. 5607-900A	1 490 EUR	153	2 367	71
Art. 5607-901A	1 270 EUR	153	2 367	71
Art. 5607-900C	1 490 EUR	250	3 724	71
Art. 5607-901C	1 270 EUR	250	3 724	71
H740, Verankerung A oder C				
Art. 5608-900A	1 680 EUR	243	3 620	89
Art. 5608-901A	1 440 EUR	243	3 620	89
Art. 5608-900C	1 680 EUR	340	4 975	89
Art. 5608-901C	1 440 EUR	340	4 975	89

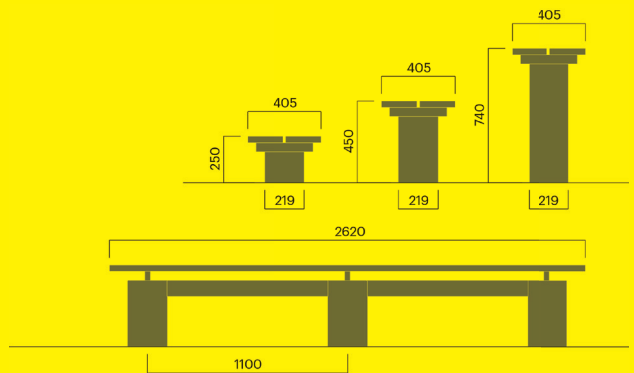

Plinth Bank, kurz

Verankerung A oder C		kg CO ₂ e	MJ	kg
Art. 5613-900A	1 270 EUR	145	2 149	64
Art. 5613-901A	1 060 EUR	145	2 149	64
Art. 5613-900C	1 270 EUR	214	3 111	75
Art. 5613-901C	1 060 EUR	214	3 111	75

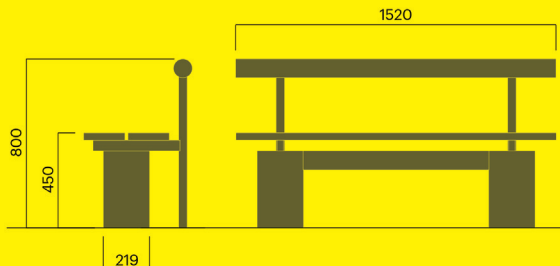

Plinth Bank, lang

Verankerung A oder C		kg CO ₂ e	MJ	kg
Art. 5614-900A	2 120 EUR	224	3 353	83
Art. 5614-901A	1 810 EUR	224	3 353	83
Art. 5614-900C	2 120 EUR	327	4 794	116
Art. 5614-901C	1 810 EUR	327	4 794	116

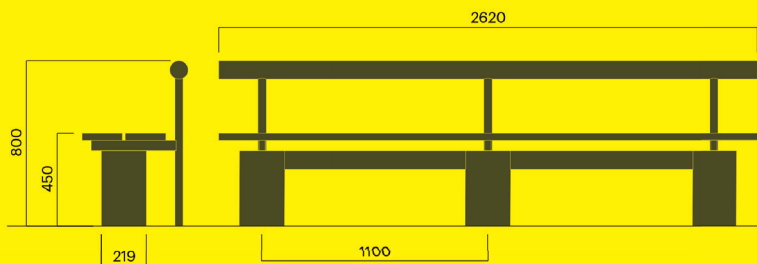

Plint Tisch, kurz

H250, Verankerung A oder C		kg CO ₂ e	MJ	kg
Art. 5632-900A	880 EUR	66	1 116	34
Art. 5632-901A	770 EUR	66	1 116	34
Art. 5632-900C	880 EUR	131	2 018	65
Art. 5632-901C	770 EUR	131	2 018	65

H450, Verankerung A oder C

Art. 5633-900A	1 090 EUR	107	1 689	56
Art. 5633-901A	910 EUR	107	1 689	56
Art. 5633-900C	1 090 EUR	168	2 528	52
Art. 5633-901C	910 EUR	168	2 528	52

H740, Verankerung A oder C

Art. 5634-900A	1 270 EUR	168	2 528	80
Art. 5634-901A	1 090 EUR	168	2 528	80
Art. 5634-900C	1 270 EUR	208	3 096	99
Art. 5634-901C	1 090 EUR	208	3 096	99

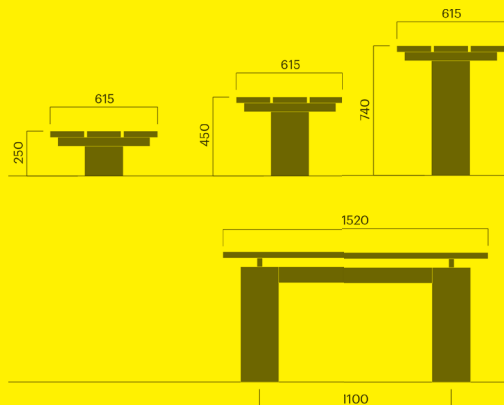

Plinth Tisch, lang

		kg CO ₂ e	MJ	kg
H250, Verankerung A oder C				
Art. 5635-900A	1 430 EUR	100	1 729	59
Art. 5635-901A	1 270 EUR	100	1 729	59
Art. 5635-900C	1 420 EUR	197	3 085	93
Art. 5635-901C	1 270 EUR	197	3 085	93
H450, Verankerung A oder C				
Art. 5636-900A	1 630 EUR	162	2 592	79
Art. 5636-901A	1 460 EUR	162	2 592	79
Art. 5636-900C	1 630 EUR	259	3 949	114
Art. 5636-901C	1 460 EUR	259	3 949	114
H740, Verankerung A oder C				
Art. 5637-900A	1 840 EUR	252	3 850	111
Art. 5637-901A	1 580 EUR	252	3 850	111
Art. 5637-900C	1 840 EUR	349	5 200	128
Art. 5637-901C	1 580 EUR	349	5 200	128

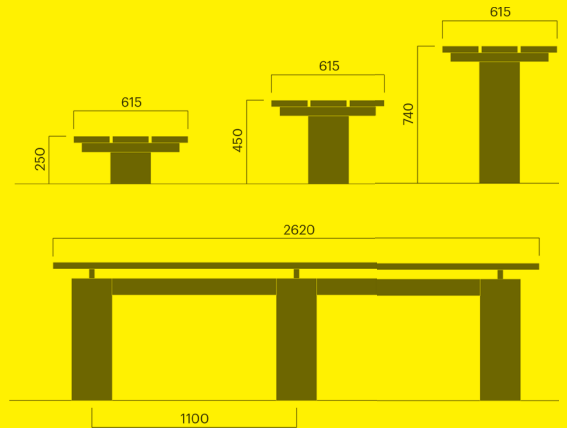

Plinth Fahrradständer

		kg CO ₂ e	MJ	kg
kurz, Verankerung A oder C				
Art. 5686-900A	400 EUR	43	600	15
Art. 5686-901A	280 EUR	43	600	15
Art. 5686-900C	400 EUR	41	573	14
Art. 5686-901C	350 EUR	41	573	13
lang, Verankerung A oder C				
Art. 5687-900A	460 EUR	77	1 079	27
Art. 5687-901A	500 EUR	77	1 079	27
Art. 5687-900C	500 EUR	69	957	26
Art. 5687-901C	400 EUR	69	957	26

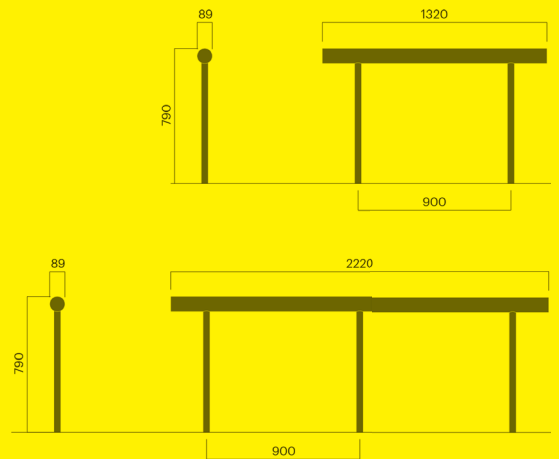

Pop



Pop Hockerbank

		kg CO ₂ e	MJ	kg
Art. 3806-900	980 EUR	63	910	24
Art. 3806-901	620 EUR	63	910	24

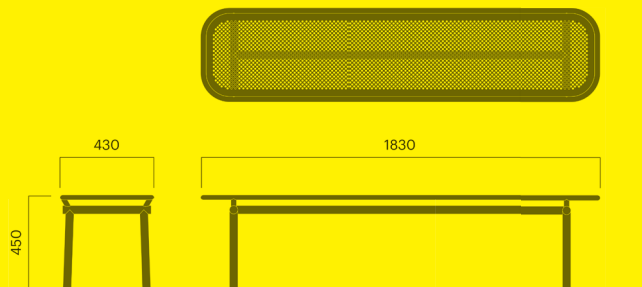

Pop Bank

		kg CO ₂ e	MJ	kg
Art. 3816-900	1 420 EUR	101	1 462	37
Art. 3816-901	1 010 EUR	101	1 462	37

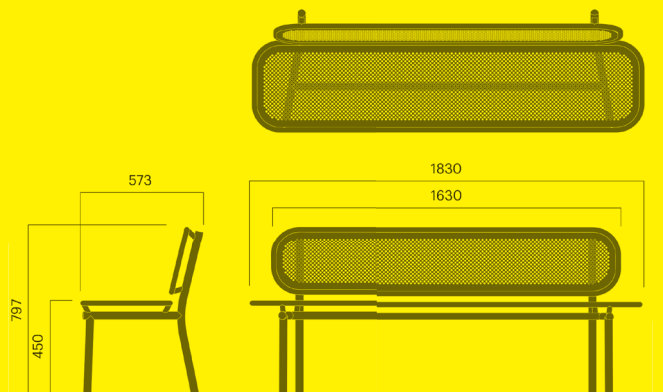

Pop Bank

mit Armlehnen		kg CO ₂ e	MJ	kg
Art. 3817-900	1 580 EUR	108	1 565	37
Art. 3817-901	1 190 EUR	108	1 565	37

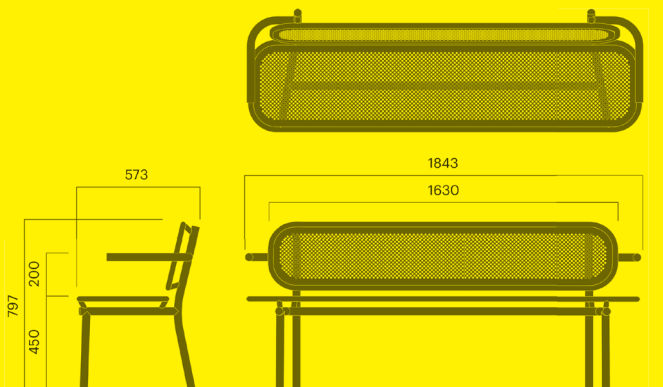

Pop Tisch

		kg CO ₂ e	MJ	kg
Art. 3836-900	960 EUR	88	1 286	42
Art. 3836-901	790 EUR	88	1 286	42

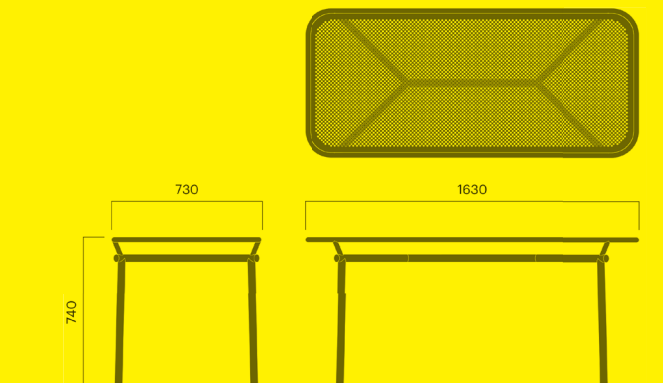

Pop Pflanzkasten

104 Liter

		kg CO ₂ e	MJ	kg
110 Liter, niedrig				
Art. 3880-900	1160 EUR	277	3 857	135
Art. 3880-901	980 EUR	277	3 857	41
210 Liter, hoch				
Art. 3882-900	1650 EUR	457	6 357	135
Art. 3882-901	1450 EUR	457	6 357	128

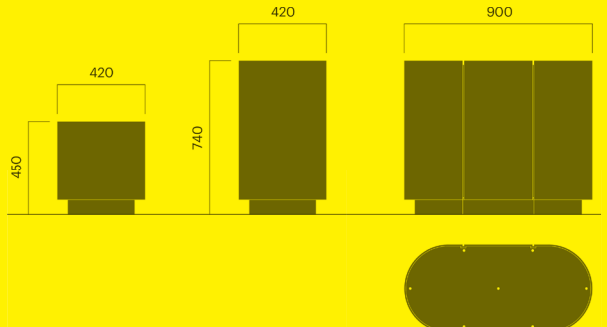

Pop Pflanzkasten

240 Liter

		kg CO ₂ e	MJ	kg
240 Liter, niedrig				
Art. 3884-900	2 250 EUR	567	7 892	167
Art. 3884-901	1 980 EUR	567	7 892	148
440 Liter, hoch				
Art. 3886-900	2 680 EUR	819	11 401	246
Art. 3886-901	2 380 EUR	819	11 401	246

mit Pop Spalieren kombinierbar

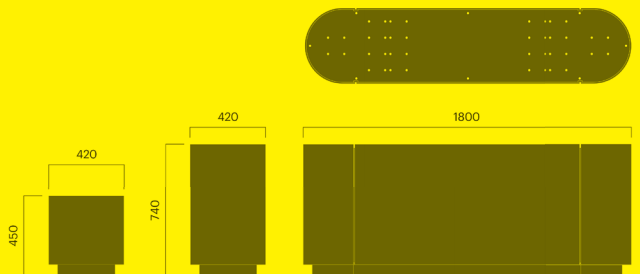

Pop Spalier #1

		kg CO ₂ e	MJ	kg
Art. 3870-900A	1 310 EUR	114	1 681	35
Art. 3870-901A	1 110 EUR	114	1 681	35

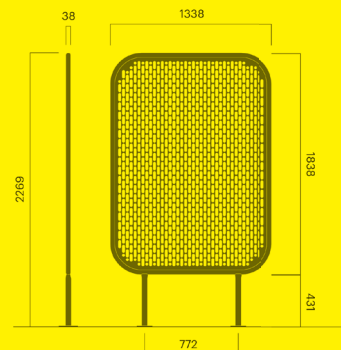

Pop Spalier #2

		kg CO ₂ e	MJ	kg
Art. 3872-900A	1 490 EUR	128	1 899	46
Art. 3872-901A	1 290 EUR	128	1 899	46

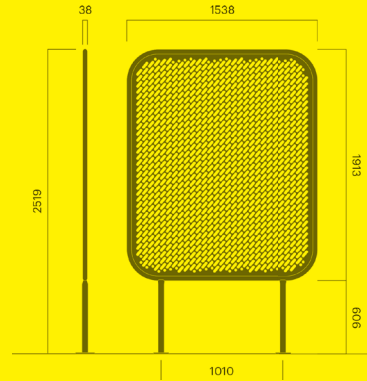

Pop Spalier #3

		kg CO ₂ e	MJ	kg
Art. 3874-900A	1 400 EUR	128	1 881	44
Art. 3874-901A	1 200 EUR	128	1 881	44

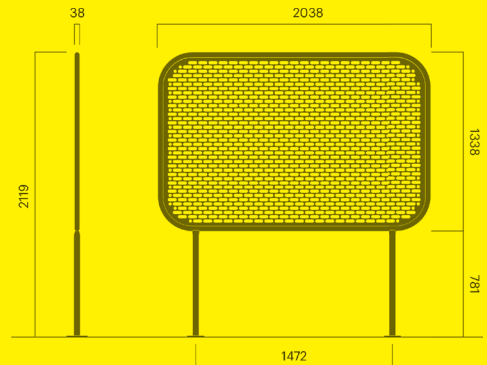

Porto



Porto Bank A

freistehend		kg CO ₂ e	MJ	kg
Art. 401-900	2 450 EUR	135	2 931	91
Art. 401-901	2 300 EUR	135	2 931	91
Maueraufsatz				
Art. 401-901MK	1 980 EUR	78	2 122	73



Porto Bank B

freistehend		kg CO ₂ e	MJ	kg
Art. 402-900	2 450 EUR	149	3 428	108
Art. 402-901	2 300 EUR	149	3 428	108
Maueraufsatz				
Art. 402-901MK	1 980 EUR	90	2 604	90

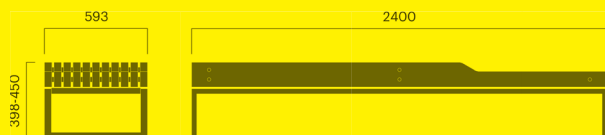

Porto Bank C

freistehend		kg CO ₂ e	MJ	kg
Art. 403-900	2 450 EUR	149	3 429	107
Art. 403-901	2 300 EUR	149	3 429	106
Maueraufsatz				
Art. 403-901MK	1 980 EUR	91	2 590	86



Porto Bank D

freistehend		kg CO ₂ e	MJ	kg
Art. 404-900	2 450 EUR	137	2 981	92
Art. 404-901	2 300 EUR	137	2 981	92
Maueraufsatz				
Art. 404-901MK	1 980 EUR	79	2 173	90



Porto Bank E

freistehend		kg CO ₂ e	MJ	kg
Art. 405-900	1 790 EUR	126	2 636	80
Art. 405-901	1 590 EUR	126	2 636	80
Maueraufsatz				
Art. 405-901MK	1 180 EUR	69	1 827	62

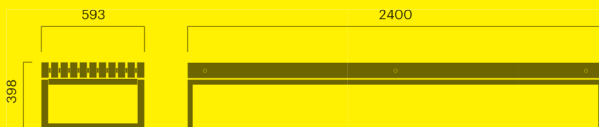

Porto Bank F

freistehend		kg CO ₂ e	MJ	kg
Art. 406-900	2 340 EUR	156	3 595	114
Art. 406-901	2 200 EUR	156	3 595	113
Maueraufsatz				
Art. 406-901MK	1 800 EUR	98	2 787	95

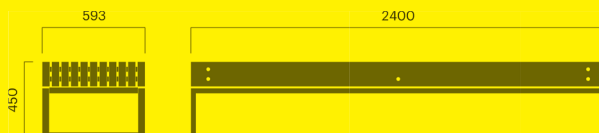

Porto Bank K

freistehend		kg CO ₂ e	MJ	kg
Art. 407-900	3 720 EUR	151	3 505	111
Art. 407-901	3 570 EUR	151	3 505	111
Maueraufsatz				
Art. 407-901MK	3 300 EUR	95	2 718	96

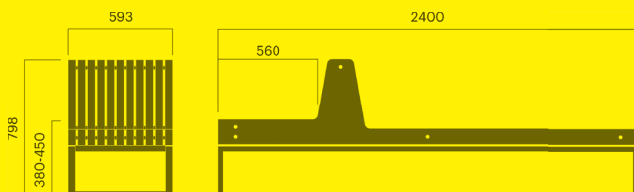

Porto Bank

Maueraufsatz, schmal

H: 135 mm		kg CO ₂ e	MJ	kg
Art. 420-900MK	850 EUR	39	1 020	33
Art. 420-901MK	830 EUR	39	1 020	33
H: 187 mm				
Art. 421-900MK	990 EUR	54	1 523	53
Art. 421-901MK	990 EUR	54	1 523	51

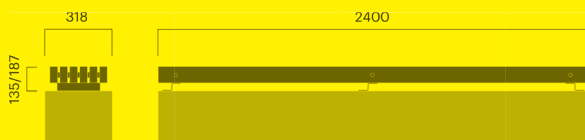

Porto Bank E

Armlehne (1 Stück) für Modell E		kg CO ₂ e	MJ	kg
Art. 425-900E	210 EUR	8	116	3
Art. 425-901E	190 EUR	8	116	3

Rückenlehne L=1600 für Bank Typ E und F		kg CO ₂ e	MJ	kg
Art. 423-900E	810 EUR	33	748	23
Art. 423-901E	730 EUR	33	748	23

Rücken- und eine Armlehne rechts		kg CO ₂ e	MJ	kg
Art. 427-900	510 EUR	27	410	10
Art. 427-901	470 EUR	27	410	10
Art. 428-900	510 EUR	27	410	10
Art. 428-901	470 EUR	27	410	10

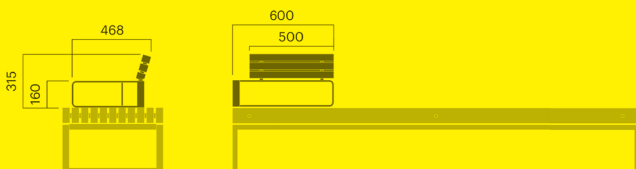

Reale



Reale Pflanzkasten

130 Liter		kg CO ₂ e	MJ	kg
Art. rea 065-057	940 EUR	-	-	35



Reale Pflanzkasten

340 Liter

kg CO₂e

MJ

kg

Art. rea 090-090

1 370 EUR

-

-

75

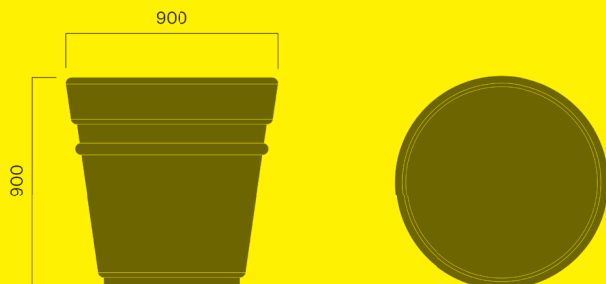

Reale Pflanzkasten

600 Liter

kg CO₂e

MJ

kg

Art. rea 120-070

1 520 EUR

-

-

80



Reale Pflanzkasten

1100 Liter

kg CO₂e

MJ

kg

Art. rea 130-130

2 940 EUR

-

-

140

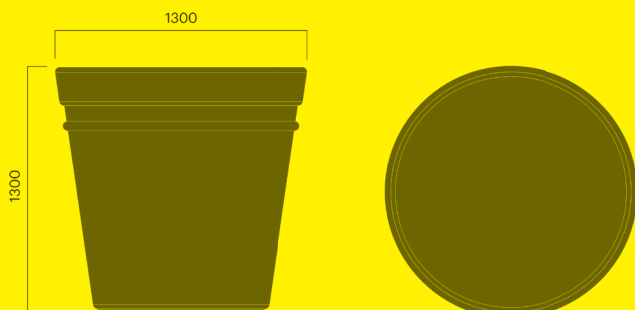



Sinus Fahrradständer

für 5 Fahrräder

Verankerung A oder C		kg CO ₂ e	MJ	kg
Art. 381-900A	500 EUR	64	866	18
Art. 381-901A	420 EUR	64	866	18
Art. 381-900C	420 EUR	65	889	18
Art. 381-901C	360 EUR	65	889	18

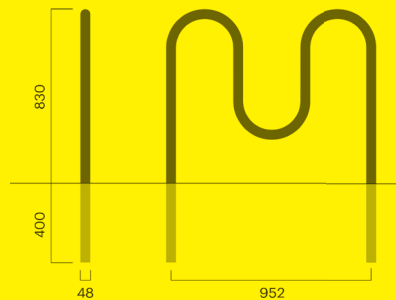

Sinus Fahrradständer

für 7 Fahrräder

Verankerung A oder C		kg CO ₂ e	MJ	kg
Art. 383-900A	570 EUR	88	1195	24
Art. 383-901A	510 EUR	88	1195	24
Art. 383-900C	510 EUR	90	1219	20
Art. 383-901C	420 EUR	90	1219	20

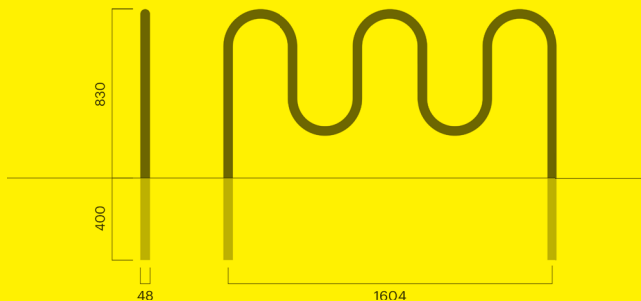

Sinus Fahrradständer

für 9 Fahrräder

Verankerung A oder C		kg CO ₂ e	MJ	kg
Art. 385-900A	680 EUR	114	1553	31
Art. 385-901A	560 EUR	114	1553	31
Art. 385-900C	610 EUR	116	1572	25
Art. 385-901C	500 EUR	116	1572	25

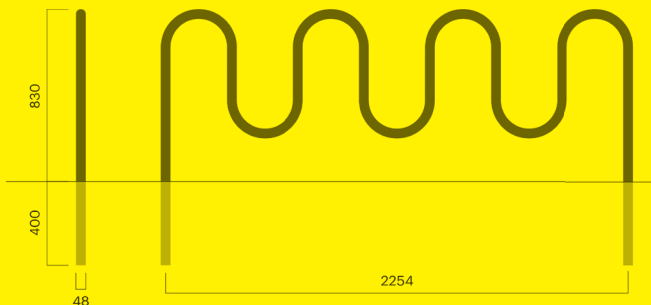



Stones Bank, Modul #1

		kg CO ₂ e	MJ	kg
H450				
Art. 5202-900	3 700 EUR	315	4 971	112
Art. 5202-901	2 990 EUR	315	4 971	112

		kg CO ₂ e	MJ	kg
H600				
Art. 5204-900	3 870 EUR	347	5 164	125
Art. 5204-901	3 160 EUR	347	5 164	125

		kg CO ₂ e	MJ	kg
Pflanzkasten H400, 320 Liter				
Art. 5280-900	2 860 EUR	373	5 197	122
Art. 5280-901	2 130 EUR	373	5 197	122

		kg CO ₂ e	MJ	kg
Pflanzkasten H550, 500 Liter				
Art. 5282-900	2 990 EUR	373	5 197	136
Art. 5282-901	2 310 EUR	373	5 197	136

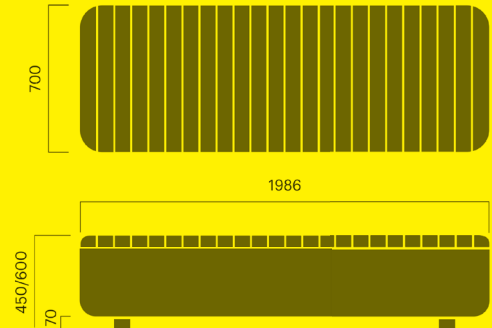

Stones Bank, Modul #2

		kg CO ₂ e	MJ	kg
H450				
Art. 5206-900	3 270 EUR	261	3 951	98
Art. 5206-901	2 630 EUR	261	3 951	98

		kg CO ₂ e	MJ	kg
H600				
Art. 5208-900	3 520 EUR	314	4 685	115
Art. 5208-901	2 800 EUR	314	4 685	115

		kg CO ₂ e	MJ	kg
Pflanzkasten H400, 320 Liter				
Art. 5284-900	2 650 EUR	326	4 545	109
Art. 5284-901	2 010 EUR	326	4 545	109

		kg CO ₂ e	MJ	kg
Pflanzkasten H550, 500 Liter				
Art. 5286-900	2 950 EUR	375	5 220	126
Art. 5286-901	2 200 EUR	375	5 220	126

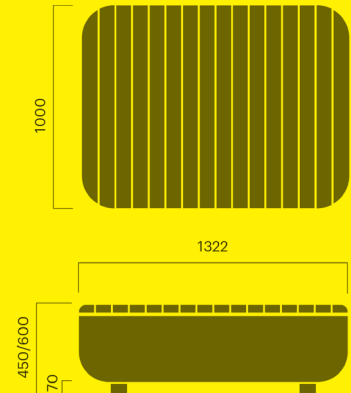

Stones Bank, Modul #3

		kg CO ₂ e	MJ	kg
H450				
Art. 5210-900	3 940 EUR	348	5 352	135
Art. 5210-901	3 200 EUR	348	5 352	135

		kg CO ₂ e	MJ	kg
H600				
Art. 5212-900	4 120 EUR	415	6 290	157
Art. 5212-901	3 410 EUR	415	6 290	157

		kg CO ₂ e	MJ	kg
Pflanzkasten H400, 320 Liter				
Art. 5288-900	3 090 EUR	460	6 412	156
Art. 5288-901	2 440 EUR	460	6 412	156

		kg CO ₂ e	MJ	kg
Pflanzkasten H550, 500 Liter				
Art. 5290-900	3 300 EUR	524	7 294	177
Art. 5290-901	2 630 EUR	524	7 294	177

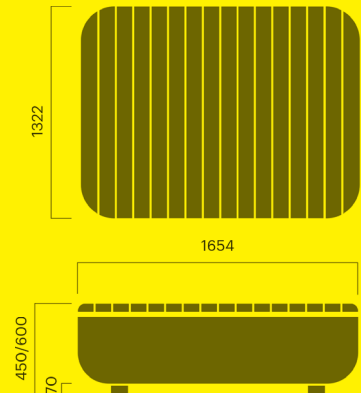

Stoop



Stoop Mini

		kg CO ₂ e	MJ	kg
Art. 2413-900	3 190 EUR	507	7 275	141
Art. 2413-901	2 700 EUR	507	7 275	141

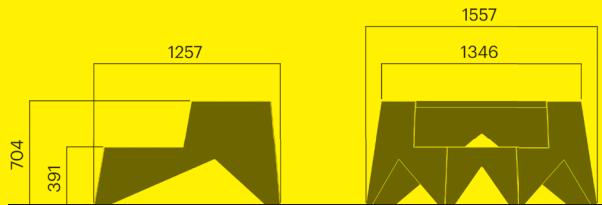

Stoop

		kg CO ₂ e	MJ	kg
Art. 2417-900	4 500 EUR	615	9 168	226
Art. 2417-901	3 700 EUR	615	9 168	226

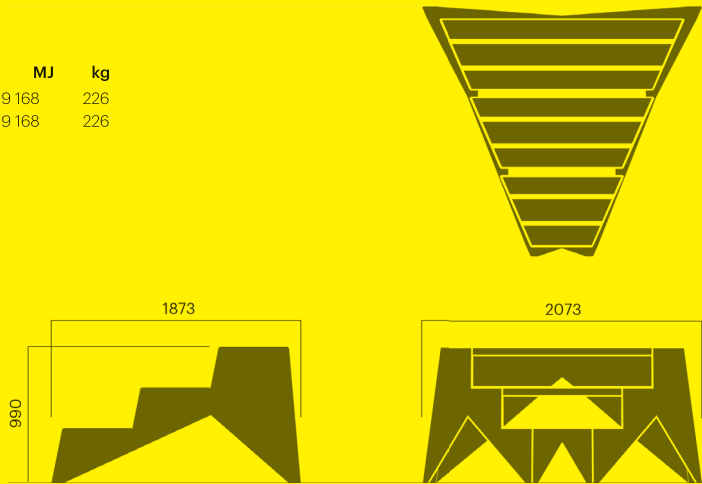

Stoop Picknick Tischbank

		kg CO ₂ e	MJ	kg
Art. 2422-900	3 500 EUR	442	6 898	207
Art. 2422-901	3 160 EUR	442	6 898	207

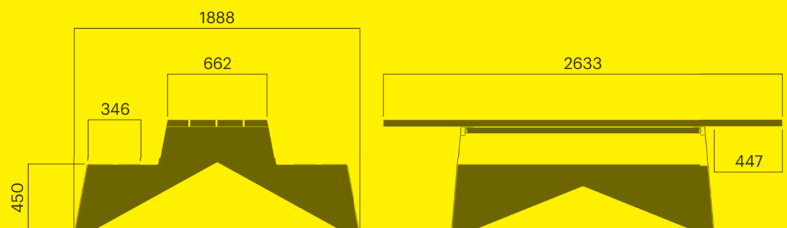



Stripes Hockerbank

		kg CO ₂ e	MJ	kg
Art. 3606-900	2 290 EUR	151	2 713	80
Art. 3606-901	2 120 EUR	151	2 713	79

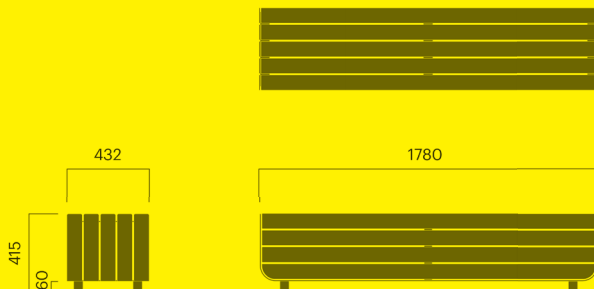

Stripes Hockerbank

Start- und Endmodul		kg CO ₂ e	MJ	kg
Art. 3607-900	1 950 EUR	142	2 413	68
Art. 3607-901	1 730 EUR	142	2 413	68
Anbaumodul				
Art. 3608-900	1 560 EUR	136	2 165	56
Art. 3608-901	1 330 EUR	136	2 165	56

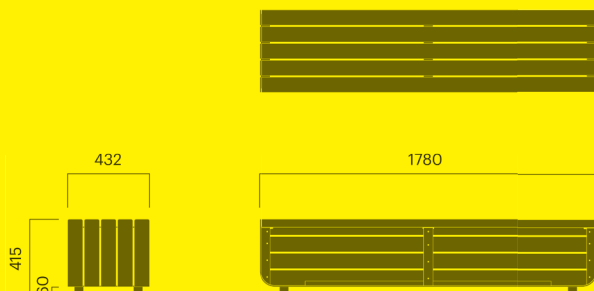

Stripes Hockerbank mit Aussparung für Bepflanzung

Start- und Endmodul		kg CO ₂ e	MJ	kg
Art. 3607-900V	2 530 EUR	180	2 932	74
Art. 3607-901V	2 330 EUR	180	2 932	75
Art. 3607-900M	2 530 EUR	177	2 885	73
Art. 3607-901M	2 330 EUR	177	2 885	77
Art. 3607-900H	2 530 EUR	180	2 932	74
Art. 3607-901H	2 330 EUR	180	2 932	74
Anbaumodul				
Art. 3608-900V	2 260 EUR	172	2 612	63
Art. 3608-901V	2 050 EUR	172	2 612	63
Art. 3608-900M	2 260 EUR	166	2 528	61
Art. 3608-901M	2 050 EUR	166	2 528	60
Art. 3608-900H	2 260 EUR	172	2 612	63
Art. 3608-901H	2 050 EUR	172	2 612	63

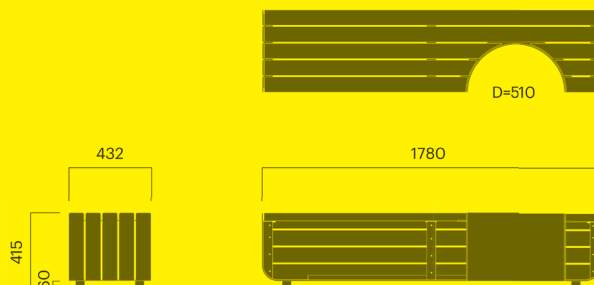

Stripes Kreisbank, klein

ø1250		kg CO ₂ e	MJ	kg
Art. 3612-900	3 630 EUR	324	4 761	108
Art. 3612-901	3 190 EUR	324	4 761	108

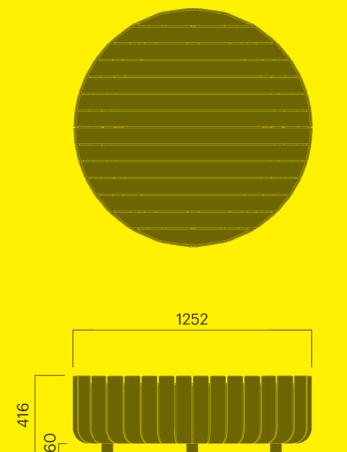

Stripes Kreisbank, groß

ø1780		kg CO ₂ e	MJ	kg
Art. 3610-900	4 260 EUR	459	7 193	184
Art. 3610-901	3 690 EUR	459	7 193	185

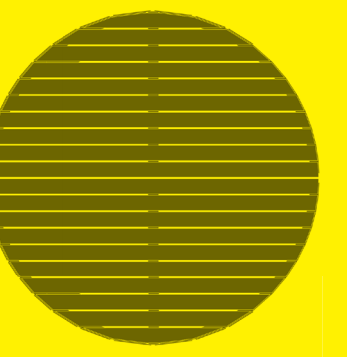

Stripes Kreisbank mit Aussparung für Bepflanzung

Aussparung kann rechts (H), links (V) oder in der Mitte (M) platziert werden.

ø1780		kg CO ₂ e	MJ	kg
Art. 3611-900HV	6 050 EUR	537	8 284	201
Art. 3611-901HV	5 330 EUR	537	8 284	212
Art. 3611-900M	6 050 EUR	518	8 012	206
Art. 3611-901M	5 330 EUR	518	8 012	208

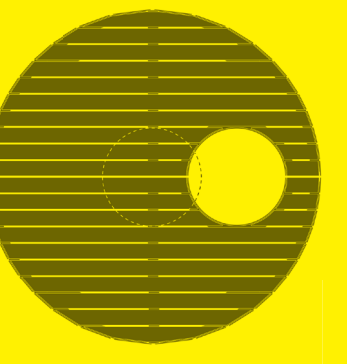

Stripes Bank, Halbkreis

offen, zum Koppeln		kg CO ₂ e	MJ	kg
Art. 3616-900	2 120 EUR	228	3 581	92
Art. 3616-901	1 850 EUR	228	3 581	92
geschlossen				
Art. 3617-900	2 560 EUR	236	3 858	104
Art. 3617-901	2 300 EUR	236	3 858	104

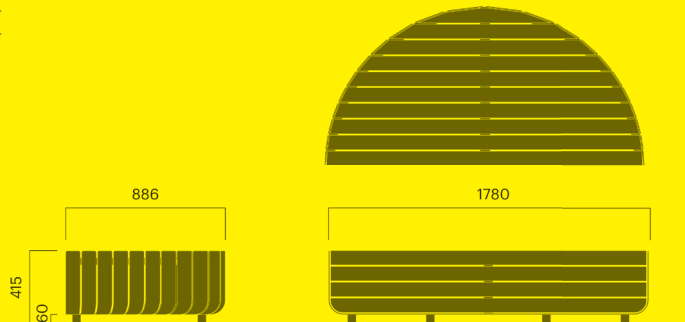

Stripes Bank, Halbkreis

		kg CO ₂ e	MJ	kg
Art. 3616-900V	3 030 EUR	269	4 142	106
Art. 3616-901V	2 660 EUR	269	4 142	95
Art. 3616-900M	3 030 EUR	261	4 058	95
Art. 3616-901M	2 660 EUR	261	4 058	95
Art. 3616-900H	3 030 EUR	269	4 142	95
Art. 3616-901H	2 660 EUR	269	4 142	95

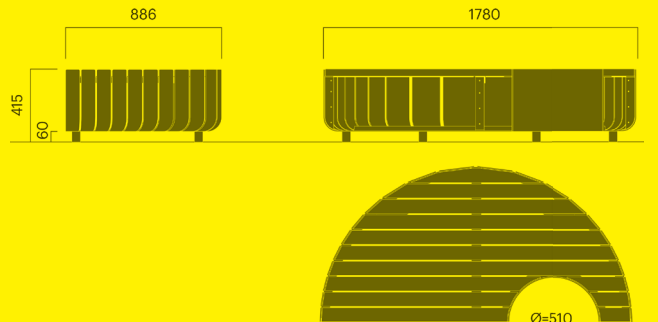

Stripes Pflanzkasten, klein

170 Liter, niedrig		kg CO ₂ e	MJ	kg
Art. 3678-900	3 190 EUR	478	6 665	151
Art. 3678-901	2 650 EUR	478	6 665	151
440 Liter, hoch				
Art. 3674-900	4 260 EUR	734	10 230	233
Art. 3674-901	3 720 EUR	734	0	232

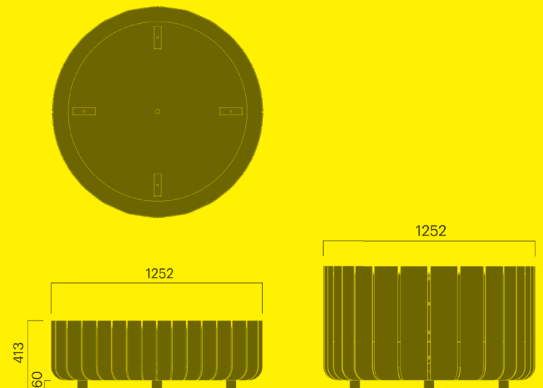

Stripes Pflanzkasten, groß

450 Liter

		kg CO ₂ e	MJ	kg
Art. 3684-900	5 080 EUR	894	12 457	281
Art. 3684-901	4 550 EUR	894	12 457	281

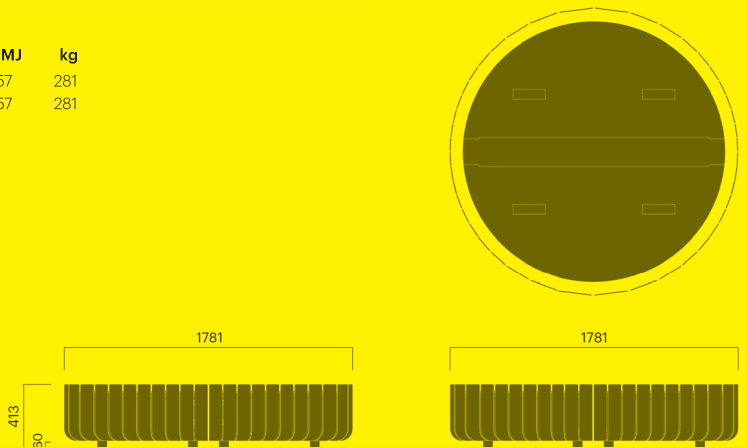

Stripes Pflanzkasten, Halbkreis

geschlossen		kg CO ₂ e	MJ	kg
Art. 3683-900	3 190 EUR	515	6 665	160
Art. 3683-901	2 650 EUR	515	0	160

offen, zum Koppeln		kg CO ₂ e	MJ	kg
Art. 3682-900	2 550 EUR	454	6 324	143
Art. 3682-901	2 270 EUR	454	0	143

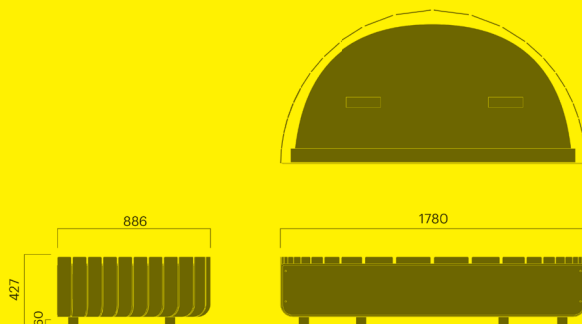

Tour



Tour Fahrradständer

für 2 Fahrräder

Verankerung A oder C		kg CO ₂ e	MJ	kg
Art. 2886-900A	420 EUR	75	1 046	24
Art. 2886-901A	340 EUR	75	1 046	24
Art. 2886-900C	410 EUR	92	1 276	29
Art. 2886-901C	330 EUR	92	1 276	29

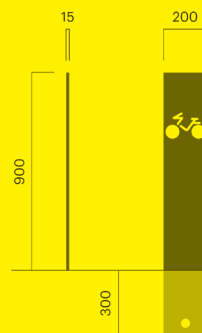

Urban



Urban Hockerbank

schmal, Verankerung A oder C

		kg CO ₂ e	MJ	kg
Art. 503-900A	850 EUR	69	1192	35
Art. 503-901A	750 EUR	69	1192	35
Art. 503-900C	850 EUR	76	1286	35
Art. 503-901C	750 EUR	76	1286	35

breit, Verankerung A oder C

Art. 504-900A	940 EUR	73	1306	40
Art. 504-901A	870 EUR	73	1306	40
Art. 504-900C	940 EUR	81	1409	40
Art. 504-901C	870 EUR	81	1409	40

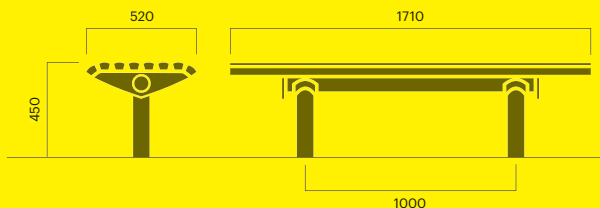

Urban Hockerbank

schmal, freistehend

		kg CO ₂ e	MJ	kg
Art. 506-900	950 EUR	80	1347	36
Art. 506-901	810 EUR	80	1347	36

breit, freistehend

Art. 507-900	1 060 EUR	85	1475	40
Art. 507-901	920 EUR	85	1475	40



Urban Hockerbank

schmal, mit Granitsockel

		kg CO ₂ e	MJ	kg
Art. 508-900	1 590 EUR	87	1 945	100
Art. 508-901	1 440 EUR	87	1 945	100

breit, mit Granitsockel

Art. 509-900	1 700 EUR	92	2 074	104
Art. 509-901	1 550 EUR	92	2 074	104

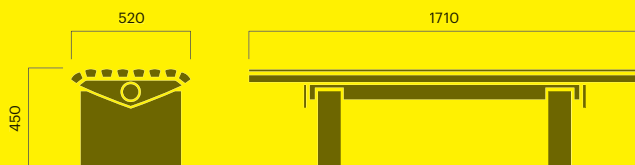

Urban Bank, Zubehör

Armlehnen-Set		kg CO ₂ e	MJ	kg
Art. 526-900	270 EUR	17	236	4
Art. 526-901	200 EUR	17	236	4

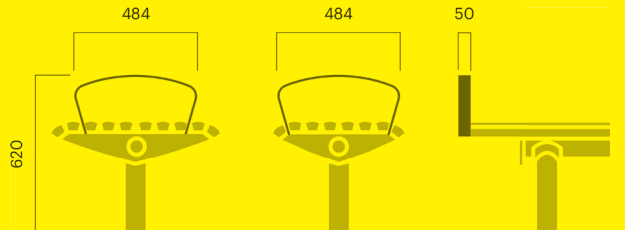

Urban Bank

Verankerung A, B oder C		kg CO ₂ e	MJ	kg
Art. 513-900A	1 080 EUR	82	1 508	44
Art. 513-901A	940 EUR	82	1 508	44
Art. 513-900B	1 080 EUR	82	1 508	44
Art. 513-901B	940 EUR	82	1 508	44
Art. 513-900C	1 080 EUR	87	1 424	47
Art. 513-901C	940 EUR	87	1 424	46

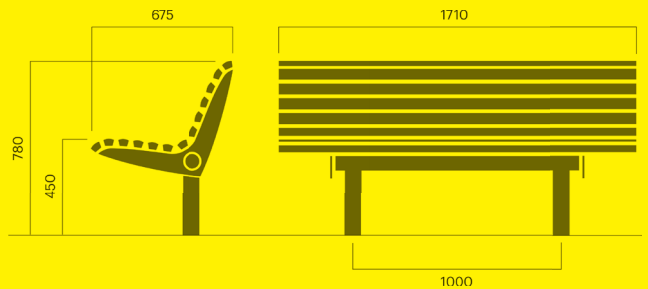

Urban Bank

freistehend		kg CO ₂ e	MJ	kg
Art. 516-900	1 380 EUR	90	1 625	47
Art. 516-901	1 250 EUR	90	1 625	47

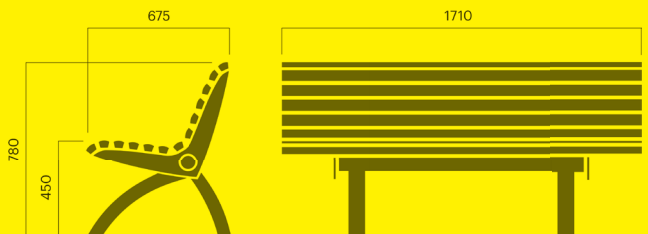

Urban Bank

mit Granitsockel

		kg CO ₂ e	MJ	kg
Art. 518-900	1980 EUR	84	1 601	101
Art. 518-901	1870 EUR	84	1 601	101

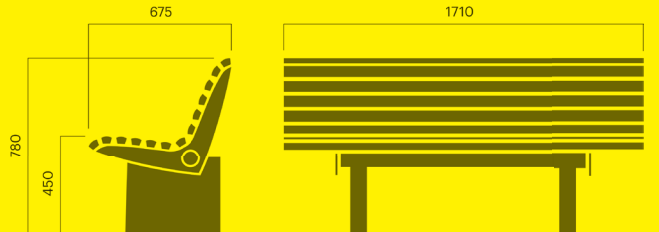

Urban Bank, Zubehör

Armlehnen-Set

		kg CO ₂ e	MJ	kg
Art. 525-900	280 EUR	19	259	6
Art. 525-901	240 EUR	19	259	6

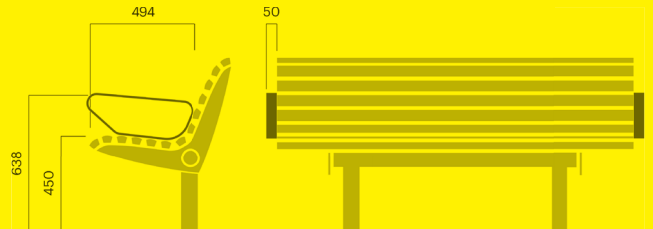

Urban Liegebank

		kg CO ₂ e	MJ	kg
Art. 566-900	1980 EUR	167	2 658	87
Art. 566-901	1690 EUR	167	2 658	79

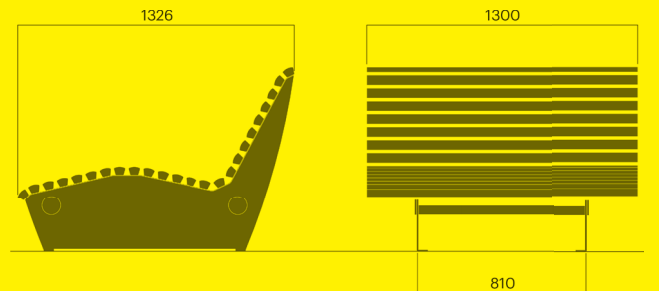

Urban Tisch

Verankerung A oder C		kg CO ₂ e	MJ	kg
Art. 533-900A	980 EUR	97	1 656	48
Art. 533-901A	850 EUR	97	1 656	48
Art. 533-900C	980 EUR	96	1 627	45
Art. 533-901C	850 EUR	96	1 627	45

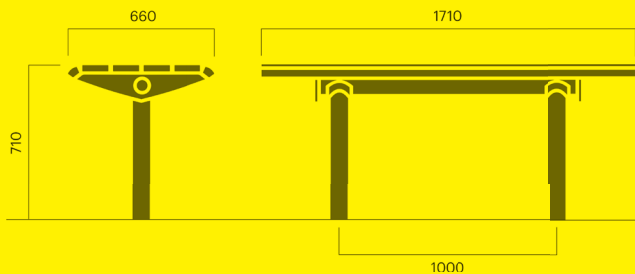

Urban Tisch

freistehend		kg CO ₂ e	MJ	kg
Art. 536-900	1 180 EUR	86	1 498	48
Art. 536-901	1 060 EUR	86	1 498	41

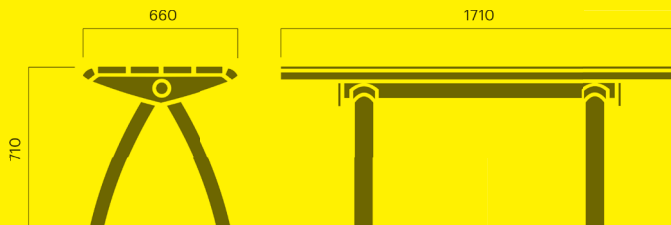

Urban Tisch

rollstuhlgerecht

Verankerung A oder C		kg CO ₂ e	MJ	kg
Art. 539-900A	1 140 EUR	102	1 772	48
Art. 539-901A	980 EUR	102	1 772	49
Art. 539-900C	1 140 EUR	97	1 711	49
Art. 539-901C	980 EUR	97	1 711	49

freistehend

Art. 539-900	1 310 EUR	102	1 722	48
Art. 539-901	1 170 EUR	102	1 722	48

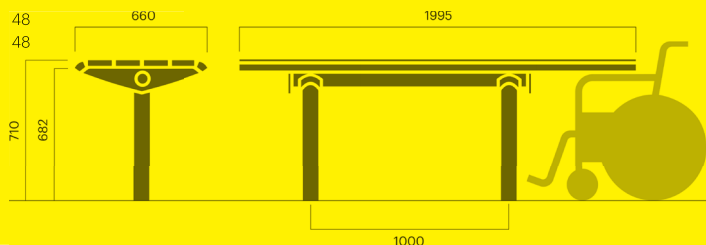

Urban Abfallbehälter

25 Liter

für Pfosten- oder Wandmontage		kg CO ₂ e	MJ	kg
Art. 541-900	650 EUR	38	535	12

für Pfosten- oder Wandmontage		kg CO ₂ e	MJ	kg
Art. 541-901	580 EUR	38	535	12

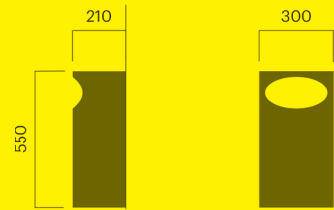

Urban Abfallbehälter

100 Liter

für Wandmontage		kg CO ₂ e	MJ	kg
Art. 546-900	1 240 EUR	120	1 680	45
Art. 546-901	1 040 EUR	120	1 680	38

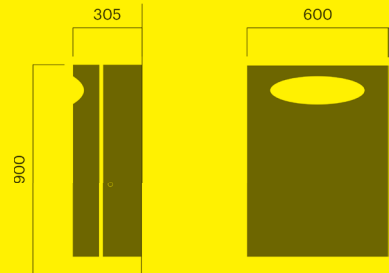

Urban Abfallbehälter

100 Liter

Standart		kg CO ₂ e	MJ	kg
Art. 542-900	1 460 EUR	154	2 240	63
Art. 542-901	1 260 EUR	154	2 240	62

mit Aschenbecher		kg CO ₂ e	MJ	kg
Art. 543-900	1 780 EUR	160	2 368	63
Art. 543-901	1 580 EUR	160	2 368	81

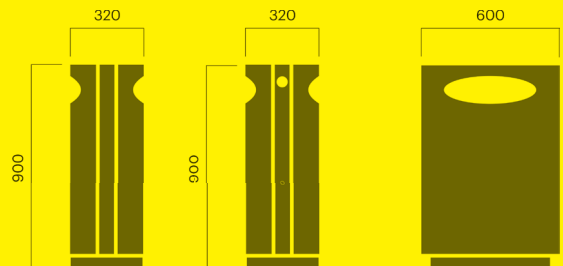

Urban Abfallbehälter

Standart		kg CO ₂ e	MJ	kg
Art. 544-900	1 560 EUR	183	2 712	81
Art. 544-901	1 360 EUR	183	2 712	81

mit Aschenbecher

Art. 545-900	1 780 EUR	194	2 926	75
Art. 545-901	1 580 EUR	194	2 926	83

2 x 70 Liter

Art. 547-900	1 950 EUR	209	3 067	88
Art. 547-901	1 570 EUR	209	3 067	83

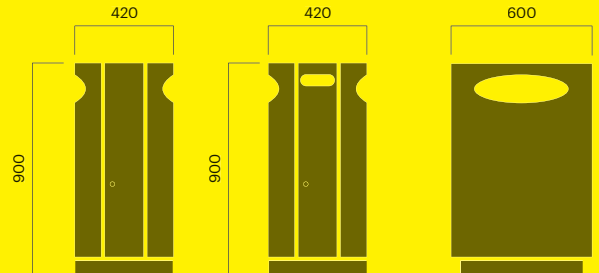

Urban Abfallbehälter

100 Liter		kg CO ₂ e	MJ	kg
Art. 542-002	120 EUR	8	138	2

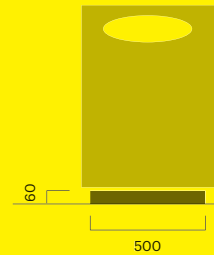

Urban Abfallbehälter

200 Liter		kg CO ₂ e	MJ	kg
Art. 548-900	2 250 EUR	248	3 694	112
Art. 548-901	1 950 EUR	248	3 694	114

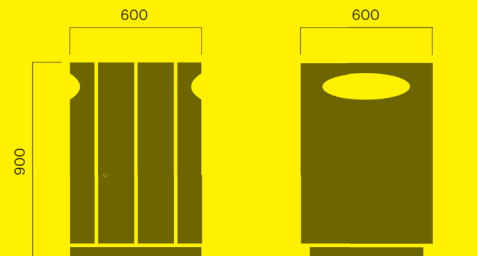

Urban Abfallbehälter

3 x 80 Liter

		kg CO ₂ e	MJ	kg
Art. 572-900	2 980 EUR	280	3 913	89
Art. 572-901	2 680 EUR	280	3 913	85

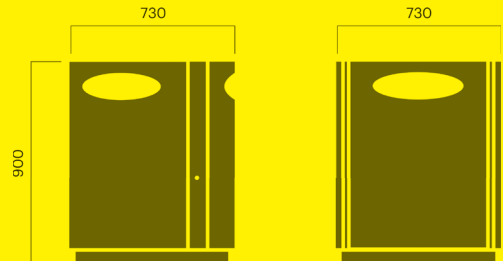

Urban Montagepfosten für Abfallbehälter

Verankerung A oder C		kg CO ₂ e	MJ	kg
Art. 592-900A	250 EUR	54	746	18
Art. 592-901A	220 EUR	54	746	18
Art. 593-900C	300 EUR	74	746	25
Art. 593-901C	240 EUR	54	746	25

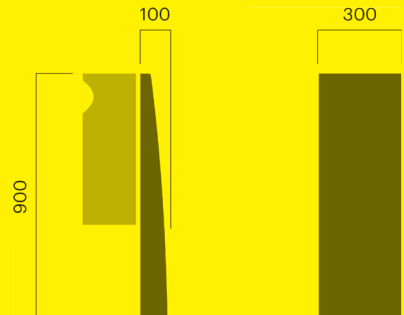

Urban Aschenbecher

7 liter		kg CO ₂ e	MJ	kg
Art. 560-900	580 EUR	37	513	8
Art. 560-901	480 EUR	37	513	8

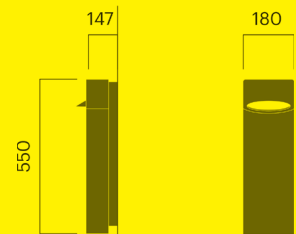

Urban Abfallbehälter, Edelstahlmantel

für Betonsockel 140 Liter		kg CO ₂ e	MJ	kg
Art. 544-002	130 EUR	8	138	2

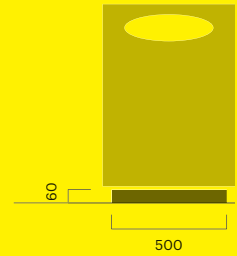

Urban Fahrradpoller

für 2 Fahrräder

Verankerung A oder C		kg CO ₂ e	MJ	kg
Art. 586-900A	260 EUR	34	470	11
Art. 586-901A	230 EUR	34	470	11
Art. 586-900C	230 EUR	31	437	10
Art. 586-901C	200 EUR	31	437	10
mit LED-Beleuchtung				
Art. 586-900A-LED	700 EUR	36	496	11
Art. 586-900C-LED	670 EUR	34	468	11
Art. 586-901A-LED	630 EUR	36	496	11
Art. 586-901C-LED	600 EUR	34	468	11
demontierbar				
Art. 586-900D	630 EUR	46	646	11
Art. 586-901D	580 EUR	46	646	14

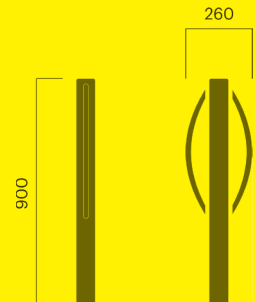

Urban Baumschutz

zum Aufschrauben		kg CO ₂ e	MJ	kg
Art. 558-900	1 050 EUR	148	2 065	47
Art. 558-901	900 EUR	148	2 065	47
zum Einbetonieren				
Art. 559-901	260 EUR	22	314	7

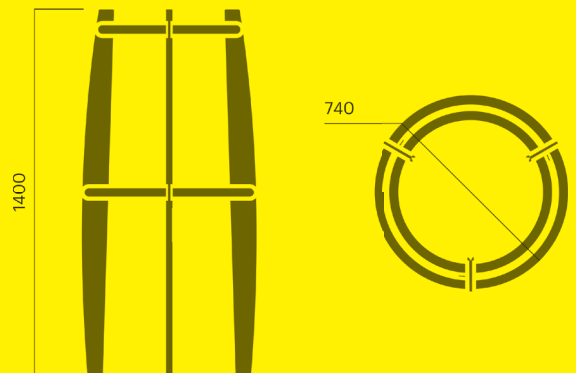

Urban Baumschutzgitter

quadratisch, 1200x1200		kg CO ₂ e	MJ	kg
Art. 565-900	1 260 EUR	272	3 800	88
Art. 565-901	1 030 EUR	272	3 800	86
rund, ø1380				
Art. 565-900R	1 260 EUR	260	3 623	82
Art. 565-901R	1 030 EUR	260	3 623	95

weitere Größen und ausgelaserte Motive auf Anfrage

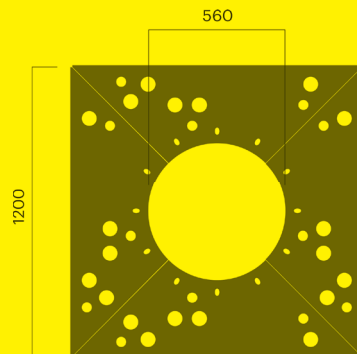

Urban Poller, D76

Verankerung A oder C		kg CO ₂ e	MJ	kg
Art. 585-900A	190 EUR	27	371	9
Art. 585-901A	170 EUR	27	371	9
Art. 585-900C	170 EUR	22	305	7
Art. 585-901C	150 EUR	27	371	7
demontierbar				
Art. 585-900D	300 EUR	28	395	9
Art. 585-901D	280 EUR	28	395	9

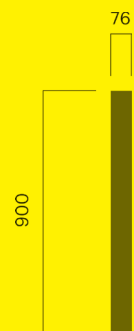

Urban Poller, D127

Verankerung A oder C		kg CO ₂ e	MJ	kg
Art. 588-900A	360 EUR	60	831	19
Art. 588-901A	340 EUR	60	831	14
Art. 588-900C	350 EUR	54	747	17
Art. 588-901C	310 EUR	54	747	17
demontierbar				
Art. 588-900D	460 EUR	60	838	19
Art. 588-901D	410 EUR	60	838	19

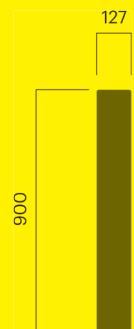

Urban Poller

mit Befestigung für Kette oder Seil (siehe Zubehör)

Verankerung A oder C		kg CO ₂ e	MJ	kg
Art. 584-900A	290 EUR	27	376	9
Art. 584-901A	270 EUR	27	376	10
Art. 584-900C	280 EUR	29	400	9
Art. 584-901C	260 EUR	29	400	9
demontierbar				
Art. 584-900D	310 EUR	30	422	9
Art. 584-901D	290 EUR	30	422	10

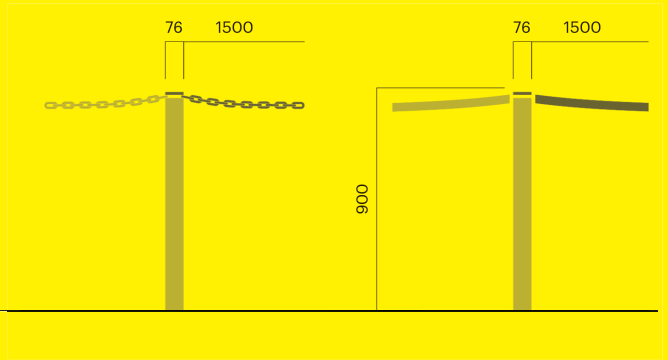

Zubehör Urban Serie

Kette, 1 Meter		kg CO ₂ e	MJ	kg
Art. 590-900	60 EUR	6	88	0
Art. 590-901	30 EUR	6	88	2
Hanfseil, 1,5 Meter				
Art. 582-900	220 EUR	9	186	2
Art. 582-901	210 EUR	9	186	4
Vogelabwehr für Abfallbehälter				
Art. 574-902	290 EUR	4	67	2

Vega



Vega Fahrradständer

für 2 Fahrräder

lackiertes Aluminium		kg CO ₂ e	MJ	kg
Art. 3996-904C	520 EUR	247	2 502	11

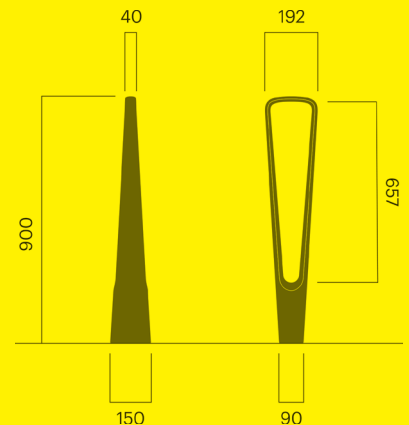



Leaf Insektenhotel

Verankerung A oder C		kg CO ₂ e	MJ	kg
Art. 5903-900A	420 EUR	40	558	13
Art. 5903-901A	310 EUR	40	558	16
Art. 5903-900C	390 EUR	41	577	13
Art. 5903-901C	280 EUR	41	577	16

Inlay perforierter Stahl vorne und hinten

Art. 5904-900	390 EUR	7	103	3
Art. 5904-901	250 EUR	7	103	3

Inlay aus Holz, massiv

Art. 5906-811	290 EUR	1	23	2
---------------	----------------	---	----	---

Hummelnest aus Holz

Art. 5907-811	290 EUR	1	23	0
---------------	----------------	---	----	---

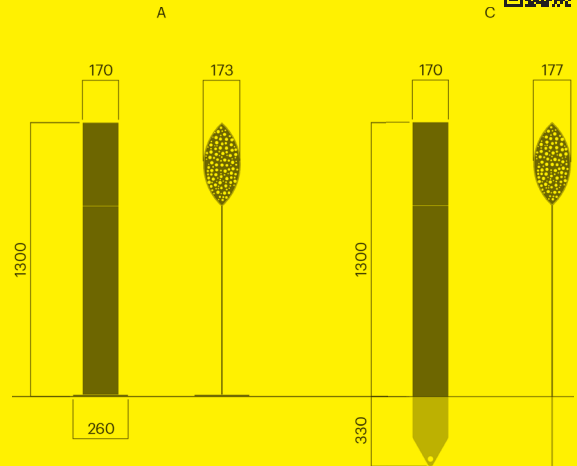

Leaf Insektenhotel, doppelt

Verankerung A oder C		kg CO ₂ e	MJ	kg
Art. 5905-900A	620 EUR	62	864	20
Art. 5905-901A	510 EUR	62	864	20
Art. 5905-900C	680 EUR	80	1119	26
Art. 5905-901C	580 EUR	80	1119	26

Inlay perforierter Stahl vorne und hinten

Art. 5904-900	390 EUR	7	103	3
Art. 5904-901	250 EUR	7	103	3

Inlay aus Holz, massiv

Art. 5906-811	290 EUR	1	23	2
---------------	----------------	---	----	---

Hummelnest aus Holz

Art. 5907-811	290 EUR	1	23	0
---------------	----------------	---	----	---

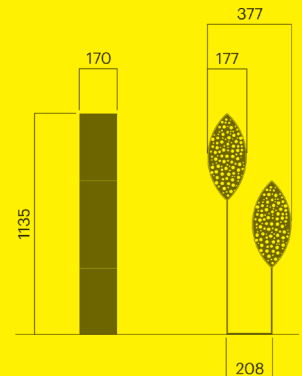

Wings

	kg CO ₂ e	MJ	kg	
Kombination aus 2 Vogel-häusern und einem Insektenhotel				
Art. 5823-900C	3 200 EUR	140	2 166	46
Art. 5823-901C	3 100 EUR	140	2 166	46
Vogelhaus einzeln, breit				
Art. 5824-904	920 EUR	46	771	11
Vogelhaus einzeln, hoch				
Art. 5825-904	990 EUR	23	374	10
Vogel- und Insektenhaus				
Art. 5826-904	990 EUR	23	381	7

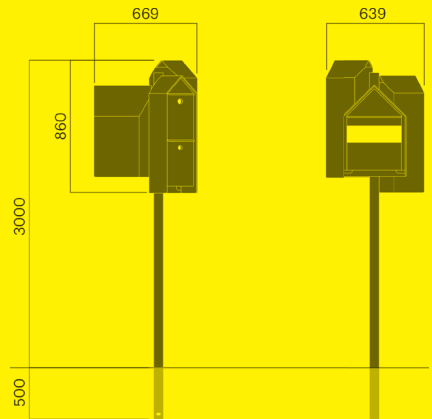

Wings Zubehör

	kg CO ₂ e	MJ	kg	
2 m Montagepfosten				
Art. 5827-900A	280 EUR	188	2 612	11
Art. 5827-901A	210 EUR	188	2 612	13
Art. 5827-900C	260 EUR	42	589	13
Art. 5827-901C	190 EUR	42	589	13
3 m Montagepfosten				
Art. 5828-900A	310 EUR	204	2 838	16
Art. 5828-901A	250 EUR	204	2 838	18
Art. 5828-900C	290 EUR	59	831	18
Art. 5828-901C	220 EUR	59	831	18
Fußplatte Ø700 mm, für 2 m Montagepfosten				
Art. 5829-900	510 EUR	151	2 109	48
Art. 5829-901	440 EUR	151	2 109	48



Decay Edge Kompost-,Pflanzkasten

	kg CO ₂ e	MJ	kg	
quadratisch, H400				
Art. 5880-900	1 980 EUR	246	3 432	117
Art. 5880-901	1 840 EUR	246	3 432	117
Art. 5880-903	1 980 EUR	246	3 432	117
quadratisch, H1000				
Art. 5884-900	3 840 EUR	615	8 580	280
Art. 5884-901	3 300 EUR	615	8 580	280
Art. 5884-903	3 840 EUR	615	8 580	280

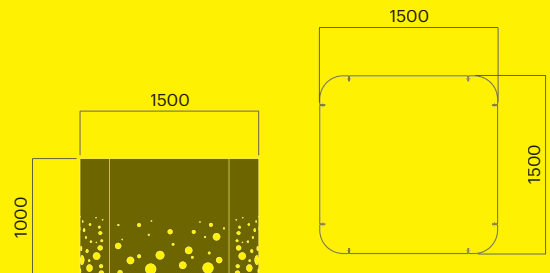

Decay Edge Kompost-,Pflanzkasten

Kreis

		kg CO ₂ e	MJ	kg
Art. 5874-900	2 330 EUR	571	7 958	187
Art. 5874-901	1 900 EUR	571	7 958	187
Art. 5874-903	2 330 EUR	573	3 870	187

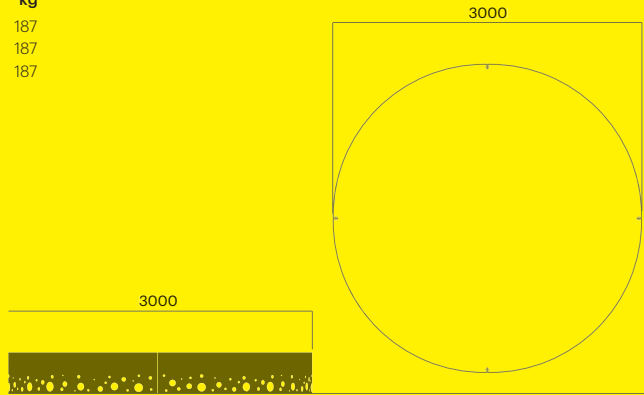

Decay Edge Module

H400

		kg CO ₂ e	MJ	kg
gerade, L1000				
Art. 5850-900	340 EUR	62	861	20
Art. 5850-901	290 EUR	62	861	20
gerade, L2000				
Art. 5852-900	600 EUR	95	1 371	37
Art. 5852-901	490 EUR	95	1 371	37
kleiner 90° Bogen, Ecke R200				
Art. 5854-900	200 EUR	28	388	514
Art. 5854-901	170 EUR	28	388	514
großer 90° Bogen, Ecke R1470				
Art. 5858-900	620 EUR	143	1 995	0
Art. 5858-901	510 EUR	143	1 995	46

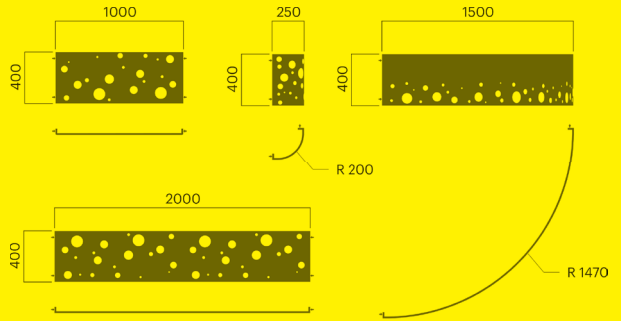

Decay Edge Module

H1000

		kg CO ₂ e	MJ	kg
gerade, L1000				
Art. 5860-900	630 EUR	162	2 255	52
Art. 5860-901	520 EUR	162	2 255	52
gerade, L2000				
Art. 5862-900	1 230 EUR	310	4 322	0
Art. 5862-901	1 020 EUR	310	4 322	101
kleiner 90° Bogen, Ecke R200				
Art. 5864-900	370 EUR	74	1 028	24
Art. 5864-901	300 EUR	74	1 028	24
großer 90° Bogen, Ecke R1470				
Art. 5868-900	1 480 EUR	370	5 156	0
Art. 5868-901	1 260 EUR	370	5 156	120

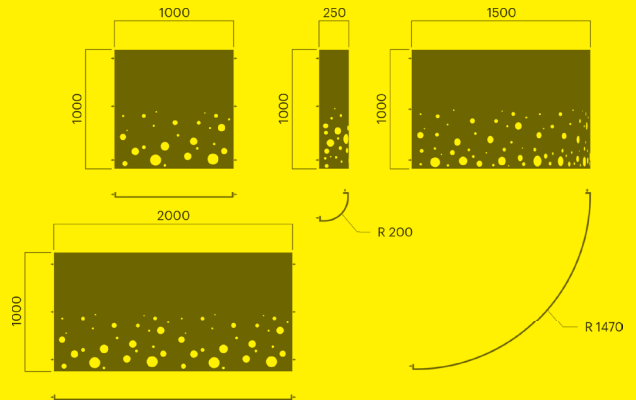

Bankrahmen für Baumstämme

Verankerung A oder C

		kg CO ₂ e	MJ	kg
Art. 5803-900A	1 870 EUR	317	4 572	105
Art. 5803-901A	1 660 EUR	317	4 572	114
Art. 5803-900C	1 980 EUR	345	4 974	114
Art. 5803-901C	1 770 EUR	345	4 974	114

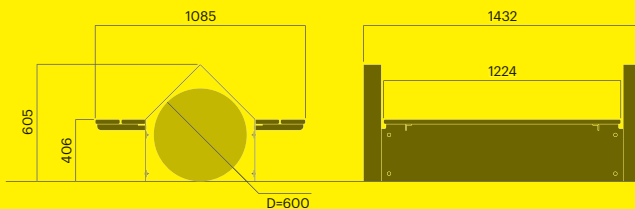

Stapelbank für Äste und Steinhaufen

Verankerung A oder C

		kg CO ₂ e	MJ	kg
Art. 5813-900A	1 900 EUR	237	3 453	78
Art. 5813-901A	1 670 EUR	237	3 453	78
Art. 5813-900C	2 010 EUR	251	3 652	82
Art. 5813-901C	1 780 EUR	251	3 652	82

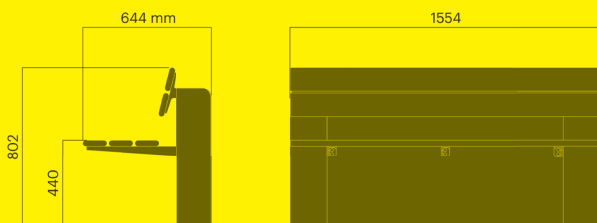

Via



Via Hockerbank, gerade

freistehend oder für Wandmontage

		kg CO ₂ e	MJ	kg
Art. 1306-900	1 690 EUR	101	2 475	85
Art. 1306-901	1 580 EUR	101	2 096	85
Art. 1306-900B	1 690 EUR	129	2 096	76
Art. 1306-901B	1 630 EUR	129	2 096	73

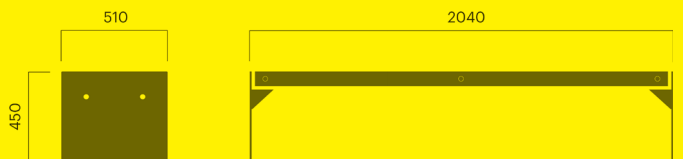

Via Bankaufsatz, gerade

		kg CO ₂ e	MJ	kg
Art. 1320-900	1 200 EUR	42	1 273	48
Art. 1320-901	1 160 EUR	42	1 273	48
Maueraufsatz				
Art. 1320-900MK	1 130 EUR	40	1 249	47
Art. 1320-901MK	1 110 EUR	40	1 249	47

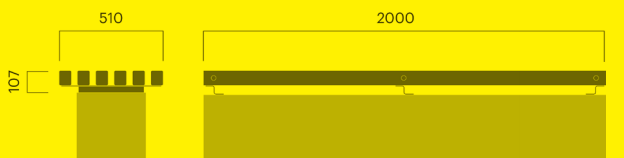

Via Hockerbank, gebogen

freistehend oder für Wandmontage		kg CO ₂ e	MJ	kg
Art. 1308-900	2 540 EUR	217	3 647	99
Art. 1308-901	2 340 EUR	217	3 647	99
Art. 1308-900B	2 600 EUR	166		83
Art. 1308-901B	2 390 EUR	166		83

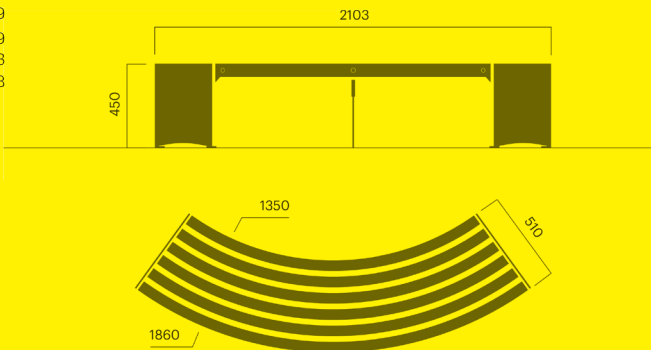

Via Hockerkreisbank

ID 2700		kg CO ₂ e	MJ	kg
Art. 1310-900	9 900 EUR	496	10 009	404
Art. 1310-901	8 900 EUR	496	10 009	404

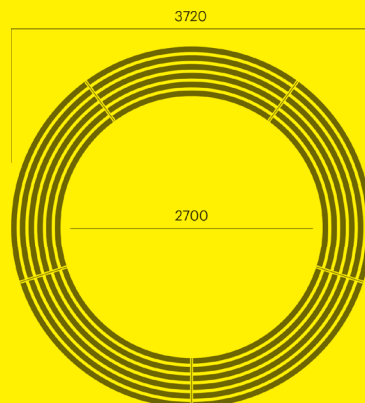

Via Bankaufsatz, gebogen

		kg CO ₂ e	MJ	kg
Art. 1330-900	2 000 EUR	99	2 001	62
Art. 1330-901	1 860 EUR	99	2 001	62

Maueraufsatz

Art. 1330-900MK	1 690 EUR	64	1 549	46
Art. 1330-901MK	1 650 EUR	64	1 549	46

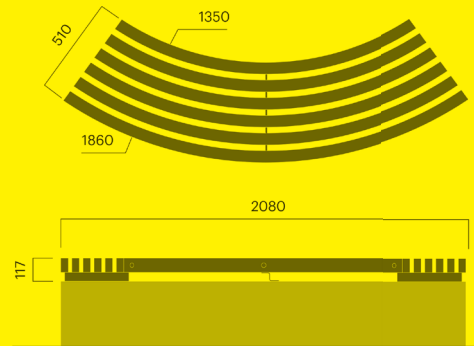

Via Verbindung / Fuß

		kg CO ₂ e	MJ	kg
Art. 1350-900	280 EUR	59	823	19
Art. 1350-901	260 EUR	59	823	19

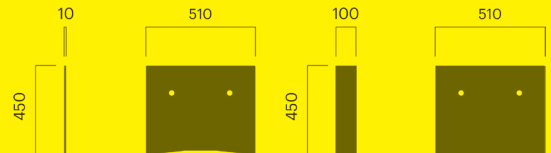

Via Doppel-Verbindung / Fuß

		kg CO ₂ e	MJ	kg
Art. 1352-900	450 EUR	136	1 888	0
Art. 1352-901	410 EUR	136	1 888	0

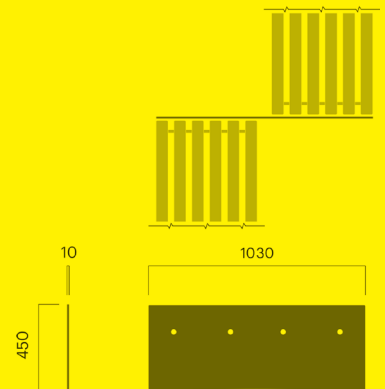

Via Zubehör

		kg CO ₂ e	MJ	kg
Rückenlehne				
Art. 1325-900	240 EUR	13	185	4
Art. 1325-901	200 EUR	13	185	4
Armlehne (1 Stück)				
Art. 1327-900	620 EUR	12	190	5
Art. 1327-901	570 EUR	12	190	5

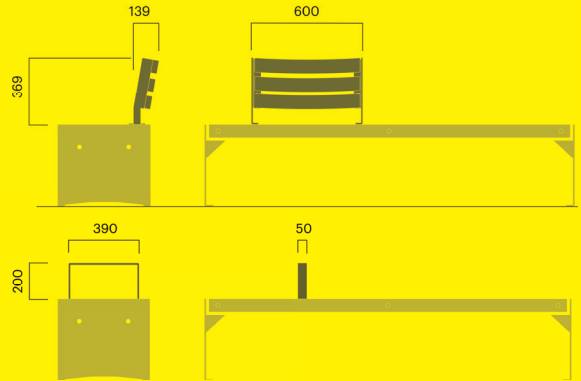

Via Tisch, gerade

		kg CO ₂ e	MJ	kg
Art. 1336-900	2 250 EUR	242	4 286	112
Art. 1336-901	2 070 EUR	242	4 286	112

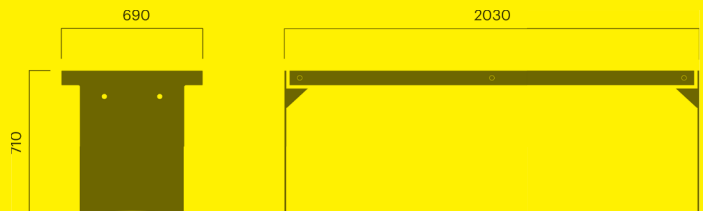

Via Tisch, gebogen

		kg CO ₂ e	MJ	kg
Art. 1338-900	1 580 EUR	210	3 330	87
Art. 1338-901	1 460 EUR	210	3 330	87

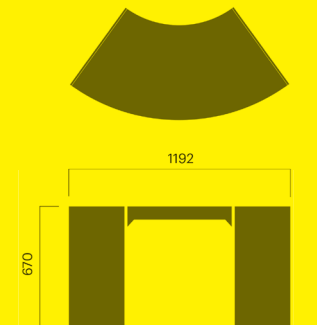

Via Pflanzbehälter

		kg CO ₂ e	MJ	kg
1170 Liter, niedrig				
Art. 1381-900	1 700 EUR	359	4 997	114
Art. 1381-901	1 490 EUR	359	4 997	114
350 Liter, hoch				
Art. 1384-900	2 410 EUR	639	8 892	203
Art. 1384-901	2 120 EUR	639	8 892	203

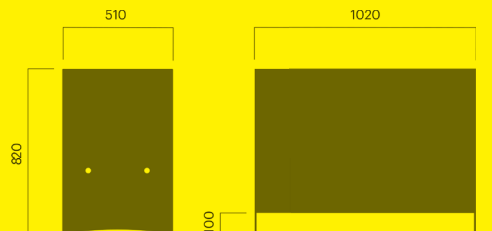

Vroom



Vroom Hockerbank, gerade Enden

		kg CO ₂ e	MJ	kg
Art. 607-900	990 EUR	148	2 298	59
Art. 607-901	890 EUR	148	2 298	59

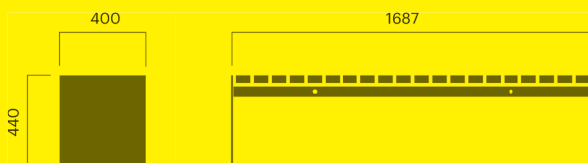

Vroom Bank, gerade Enden

		kg CO ₂ e	MJ	kg
Art. 617-900	1 580 EUR	190	2 892	90
Art. 617-901	1 410 EUR	190	2 892	89

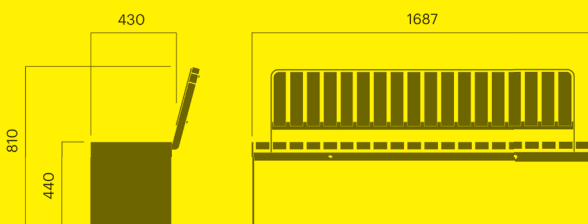

Vroom Hockerbank, gerundete Enden

		kg CO ₂ e	MJ	kg
Art. 606-900	1 290 EUR	190	2 885	72
Art. 606-901	1 140 EUR	190	2 885	72

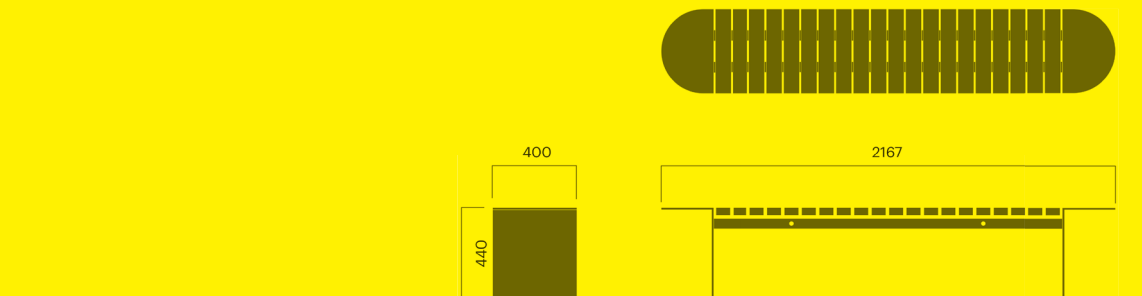

Vroom Bank, gerundete Enden

		kg CO ₂ e	MJ	kg
Art. 616-900	1 810 EUR	239	3 873	103
Art. 616-901	1 590 EUR	239	3 873	103

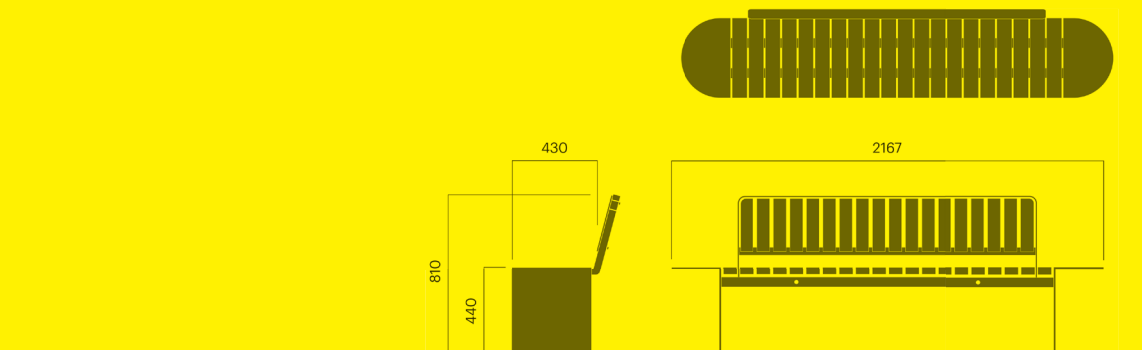

Vroom Hockerbank, 600 Sitztiefe

		kg CO ₂ e	MJ	kg
Art. 609-900	1 690 EUR	212	3 391	89
Art. 609-901	1 490 EUR	212	3 391	89

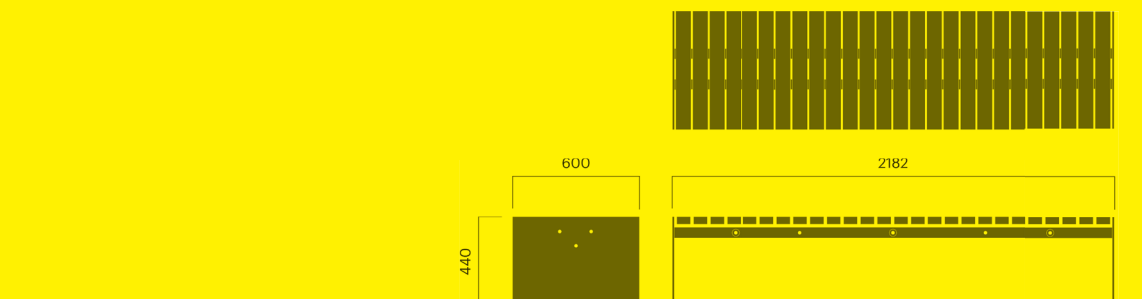

Vroom Hockerbank, 1200 Sitztiefe

		kg CO ₂ e	MJ	kg
Art. 612-900	2 980 EUR	369	6 022	161
Art. 612-901	2 740 EUR	369	6 022	0

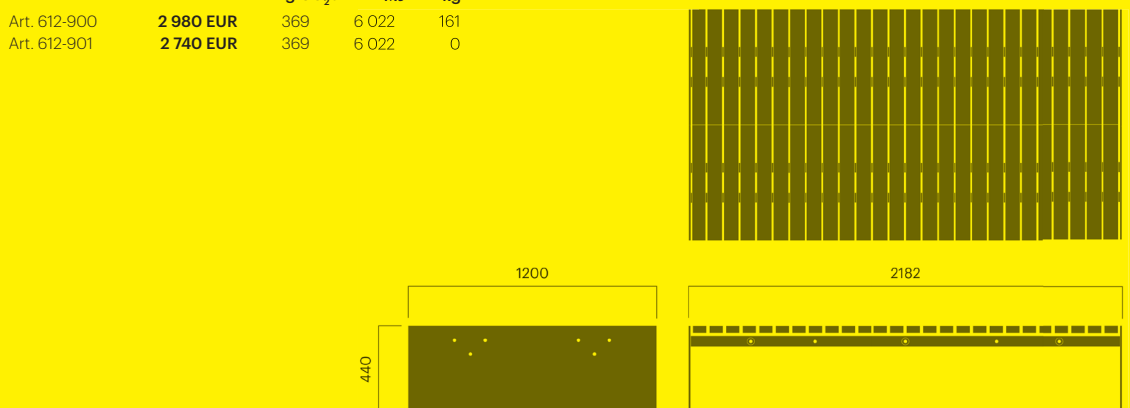

Vroom Bankaufsatz

		kg CO ₂ e	MJ	kg
kurz				
Art. 620-900JR	470 EUR	35	623	18
Art. 620-901JR	440 EUR	35	623	18
standard				
Art. 620-900	600 EUR	54	994	29
Art. 620-901	550 EUR	54	994	29
lang				
Art. 632-900	1 060 EUR	73	1 457	45
Art. 632-901	980 EUR	73	1 457	45

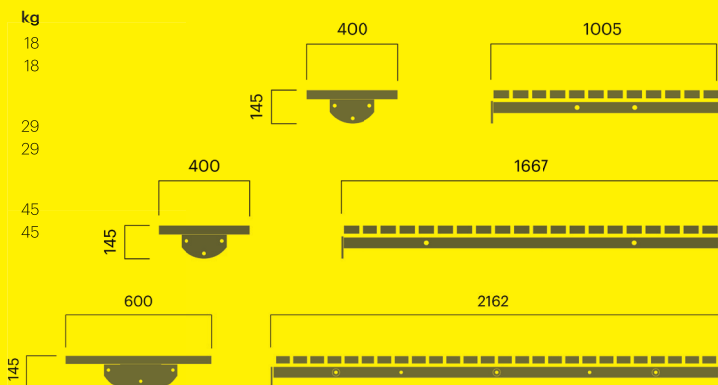

Vroom Bankaufsatz

		kg CO ₂ e	MJ	kg
H87, Maueraufsatz				
Art. 620-900MK	740 EUR	59	1 066	31
Art. 620-901MK	700 EUR	59	1 066	31
H55/Maueraufsatz, niedrig				
MKL1 = 988 mm, MKL2 = 1667 mm, MKL3 = 1984 mm				
Art. 620-901MKL1	290 EUR	18	357	13
Art. 620-901MKL2	470 EUR	29	638	21
Art. 620-901MKL3	580 EUR	38	806	26



Vroom Rückenlehnen, universal

		kg CO ₂ e	MJ	kg
Art. 629-900	600 EUR	51	1 010	31
Art. 629-901	470 EUR	51	1 010	31

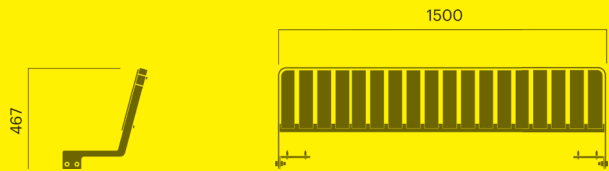

Vroom Hockerkreisbank, Einzelsegmente

		kg CO ₂ e	MJ	kg
D2000				
Art. 630-900-D2	730 EUR	47	796	22
Art. 630-901-D2	690 EUR	47	796	22
D3000				
Art. 630-900-D3	730 EUR	51	853	23
Art. 630-901-D3	690 EUR	51	853	23
D4000				
Art. 630-900-D4	730 EUR	52	871	24
Art. 630-901-D4	690 EUR	51	853	41
D5000				
Art. 630-900-D5	730 EUR	54	899	25
Art. 630-901-D5	690 EUR	52	871	25
zur Wandbefestigung				
Art. 630-900MK	730 EUR	54	899	19
Art. 630-901MK	690 EUR	54	899	19
Art. 630-901MKL	690 EUR	54	899	14

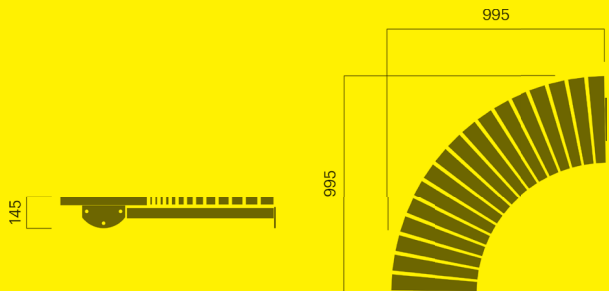

Vroom Hockerkreisbank, komplett

		kg CO ₂ e	MJ	kg
D2000 (4 Segmente)				
Art. 610-900-D2	3 600 EUR	373	5 782	147
Art. 610-901-D2	3 350 EUR	373	5 782	147
D3000 (6 Segmente)				
Art. 610-900-D3	5 800 EUR	585	9 018	228
Art. 610-901-D3	5 400 EUR	585	9 018	228
D4000 (8 Segmente)				
Art. 610-900-D4	7 800 EUR	793	12 202	308
Art. 610-901-D4	7 200 EUR	793	12 202	444
D5000 (10 Segmente)				
Art. 610-900-D5	9 900 EUR	1003	15 511	393
Art. 610-901-D5	9 200 EUR	1003	15 511	393

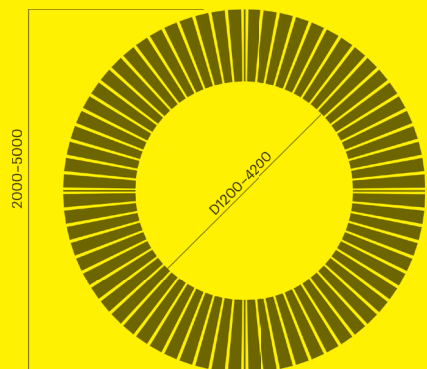

Vroom Bein/Verbindung

		kg CO ₂ e	MJ	kg
Art. 650-900	220 EUR	46	641	15
Art. 650-901	170 EUR	46	641	15
Art. 650-900C	270 EUR	46	641	20
Art. 650-901C	220 EUR	46	641	20

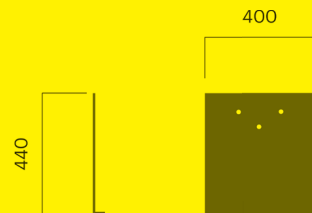

Vroom Bein/Verbindung, 600

		kg CO ₂ e	MJ	kg
Art. 673-900	310 EUR	69	960	22
Art. 673-901	270 EUR	69	960	22

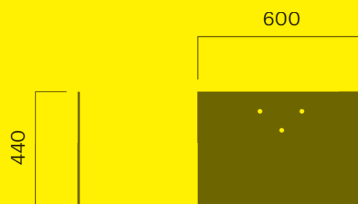

Vroom Bein/Verbindung, 1200

		kg CO ₂ e	MJ	kg
Art. 675-900	480 EUR	110	1513	35
Art. 675-901	390 EUR	110	1513	35

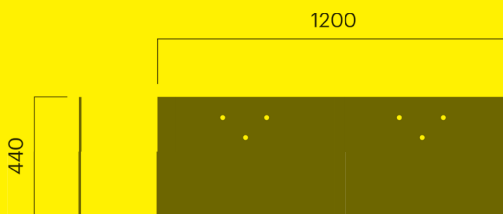

Vroom Armlehne

Armlehne (1 Stück)		kg CO ₂ e	MJ	kg
Art. 624-900	180 EUR	8	108	3
Art. 624-901	130 EUR	8	108	4
für Maueraufsatz-Variante				
Art. 624-900MK	180 EUR	8	108	5
Art. 624-901MK	130 EUR	8	108	5

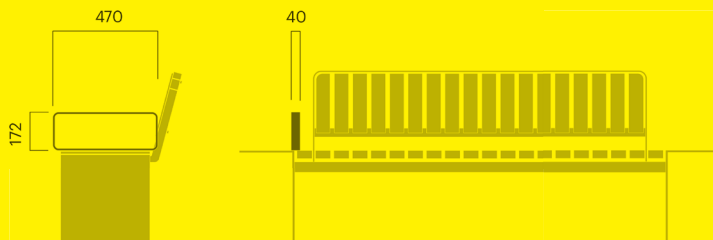

Vroom Endstück, gebogen

		kg CO ₂ e	MJ	kg
Art. 651-900	350 EUR	68	941	21
Art. 651-901	290 EUR	68	941	21

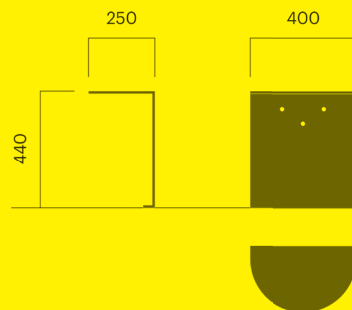

Vroom Wandhalterung

links		kg CO ₂ e	MJ	kg
Art. 658-900V	200 EUR	35	489	12
Art. 658-901V	170 EUR	35	489	12
mittig				
Art. 658-900M	280 EUR	35	489	13
Art. 658-901M	250 EUR	35	489	12
rechts				
Art. 658-900H	200 EUR	35	489	12
Art. 658-901H	170 EUR	35	489	12

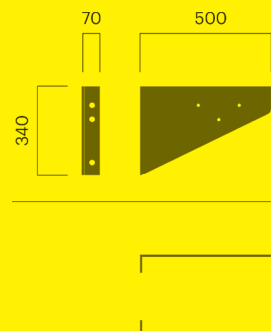

Vroom Winkel 15°

		kg CO ₂ e	MJ	kg
Art. 666-900	630 EUR	127	1775	40
Art. 666-901	520 EUR	127	1775	37

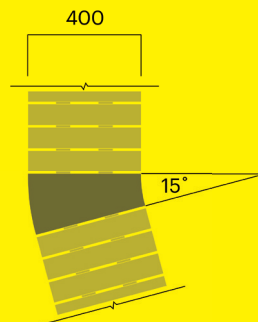

Vroom Winkel 30°

		kg CO ₂ e	MJ	kg
Art. 661-900	650 EUR	124	1733	39
Art. 661-901	570 EUR	124	1733	39

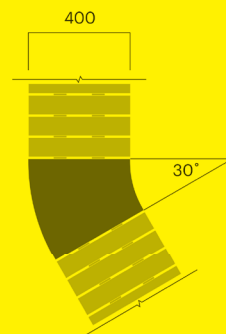

Vroom Winkel 45°

		kg CO ₂ e	MJ	kg
Art. 662-900	680 EUR	133	1850	42
Art. 662-901	620 EUR	133	1850	42

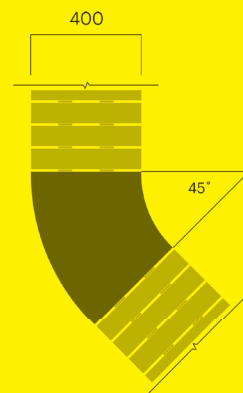

Vroom Winkel 60°

		kg CO ₂ e	MJ	kg
Art. 663-900	710 EUR	135	1 882	43
Art. 663-901	630 EUR	135	1 882	40

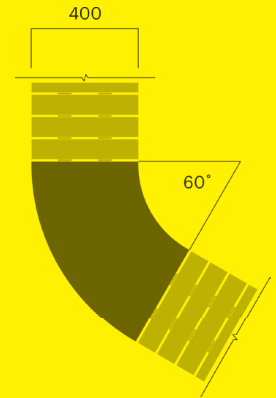

Vroom Winkel 90°

		kg CO ₂ e	MJ	kg
Art. 664-900	730 EUR	141	1 972	45
Art. 664-901	650 EUR	141	1 972	45

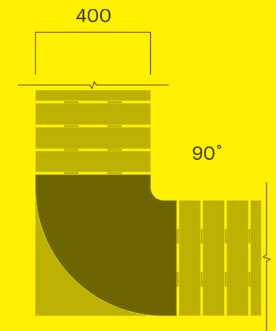

Vroom Winkel 120°

		kg CO ₂ e	MJ	kg
Art. 665-900	770 EUR	161	2 249	47
Art. 665-901	680 EUR	161	2 249	50

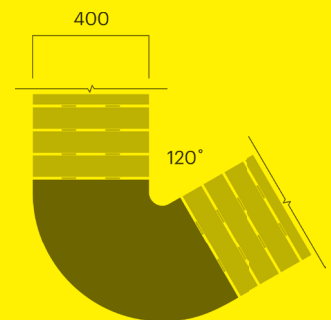

Vroom gebogene Rückenlehnen, Innenradius

		kg CO ₂ e	MJ	kg
IR1600				
Art. 622-900-D2	800 EUR	30	465	11
Art. 622-901-D2	700 EUR	30	465	11
IR1100				
Art. 622-900-D3	800 EUR	33	505	22
Art. 622-901-D3	700 EUR	33	505	22
IR1600				
Art. 622-900-D4	800 EUR	35	548	23
Art. 622-901-D4	700 EUR	35	548	23
IR2100				
Art. 622-900-D5	800 EUR	37	575	25
Art. 622-901-D5	700 EUR	37	575	25

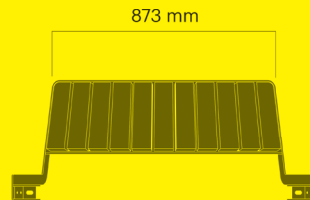

Vroom gebogene Rückenlehnen, Außenradius

		kg CO ₂ e	MJ	kg
AR1000				
Art. 623-900-D2	1 050 EUR	46	721	34
Art. 623-901-D2	920 EUR	46	721	34
AR1500				
Art. 623-900-D3	1 050 EUR	49	912	33
Art. 623-901-D3	920 EUR	49	912	33
AR2000				
Art. 623-900-D4	1 050 EUR	44	688	31
Art. 623-901-D4	920 EUR	44	688	31
AR2500				
Art. 623-900-D5	1 050 EUR	44	688	31
Art. 623-901-D5	920 EUR	44	688	31

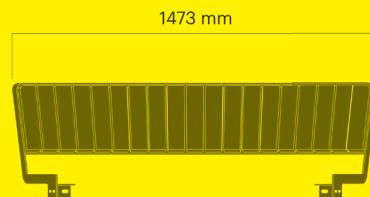

Vroom Cafétisch

		kg CO ₂ e	MJ	kg
für Bank Sitztiefe 400				
Art. 638-900	350 EUR	30	416	9
Art. 638-901	320 EUR	30	416	9
für Bank Sitztiefe 600				
Art. 639-900	350 EUR	32	444	0
Art. 639-901	320 EUR	32	444	0

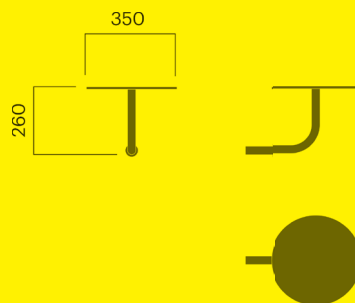

Vroom Tisch, schmal

		kg CO ₂ e	MJ	kg
Art. 635-900	1 430 EUR	214	3 344	86
Art. 635-901	1 270 EUR	214	3 344	86

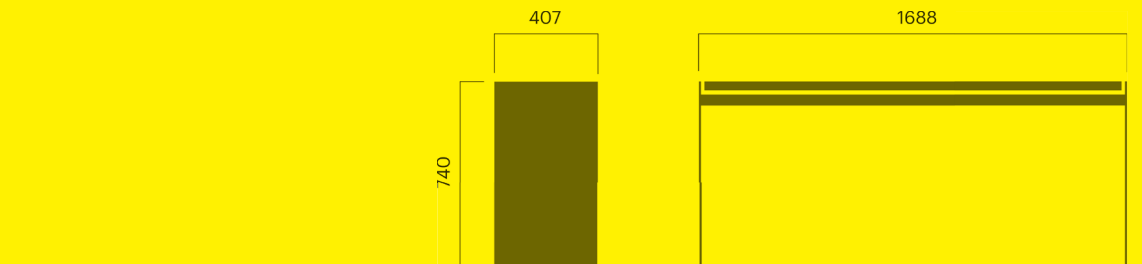

Vroom Tisch

		kg CO ₂ e	MJ	kg
alleinstehend				
Art. 636-900	1 490 EUR	215	3 642	101
Art. 636-901	1 270 EUR	215	3 642	101

		kg CO ₂ e	MJ	kg
Anbaumodul				
Art. 640-900	1 190 EUR	136	2 544	0
Art. 640-901	990 EUR	136	2 544	70

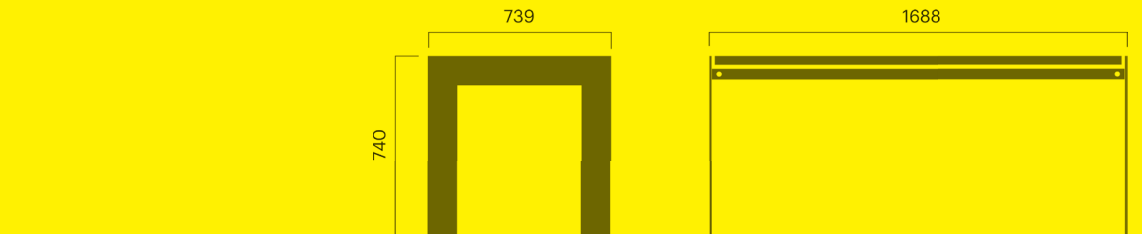

Vroom Tisch, quadratisch

		kg CO ₂ e	MJ	kg
Art. 637-900	2 650 EUR	340	5 309	137
Art. 637-901	2 410 EUR	340	5 309	130

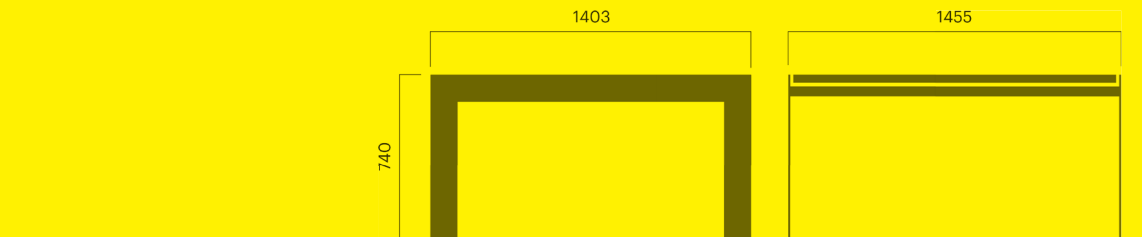

Vroom Abfallbehälter

80 Liter

		kg CO ₂ e	MJ	kg
Art. 642-900	1 700 EUR	295	4 106	93
Art. 642-901	1 430 EUR	295	4 106	93

Vorder- und Rückseite geriffelt

Art. 642-900R	1 770 EUR	285	3 982	91
Art. 642-901R	1 490 EUR	285	3 982	91

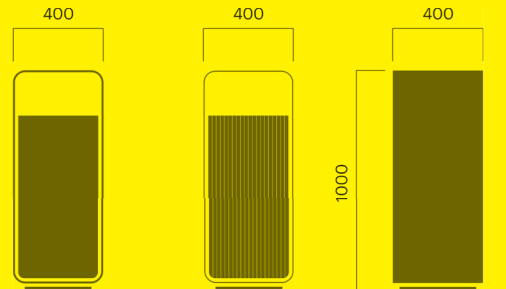

Vroom Abfallbehälter

140 Liter

		kg CO ₂ e	MJ	kg
Art. 644-900	1 850 EUR	285	3 982	126
Art. 644-901	1 690 EUR	285	3 982	126

Vorder- und Rückseite geriffelt

Art. 644-900R	1 950 EUR	396	5 514	120
Art. 644-901R	1 750 EUR	396	5 514	120

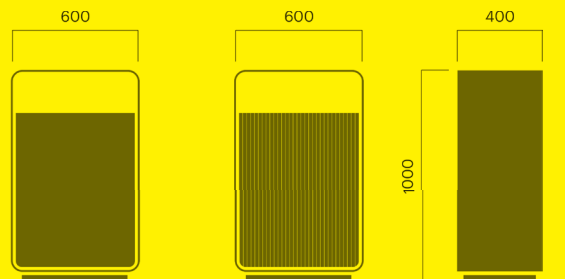

Vroom Pflanzkasten

50 Liter, klein

		kg CO ₂ e	MJ	kg
Art. 681-900	950 EUR	204	2 848	64
Art. 681-901	810 EUR	204	2 848	64

230 Liter, groß

Art. 684-900	1 990 EUR	533	7 428	169
Art. 684-901	1 750 EUR	533	7 428	169

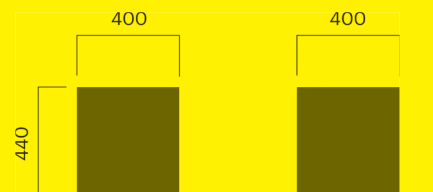

Vroom Fahrradparker

für 2 Fahrräder, lackiertes Aluminium

schmal		kg CO ₂ e	MJ	kg
Art. 686-904A	220 EUR	19	319	6
Art. 686-904C	190 EUR	21	361	7
breit				
Art. 696-904A	370 EUR	30	503	10
Art. 696-904C	240 EUR	25	418	8
A-Form				
Art. 694-904A	390 EUR	37	615	12
Art. 694-904C	260 EUR	31	514	10

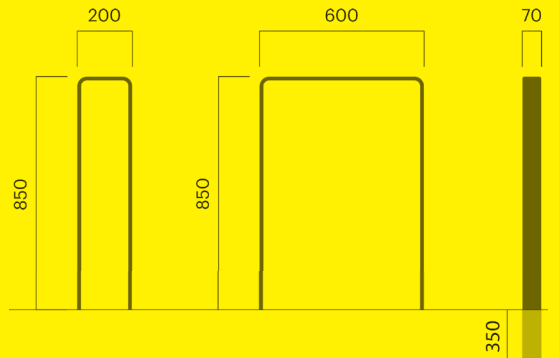

Vroom Fahrradparker

freistehendes Gestell mit
4 Fahrradparkern für 8
Fahrräder

		kg CO ₂ e	MJ	kg
Art. 688-900	1 690 EUR	250	3 695	81

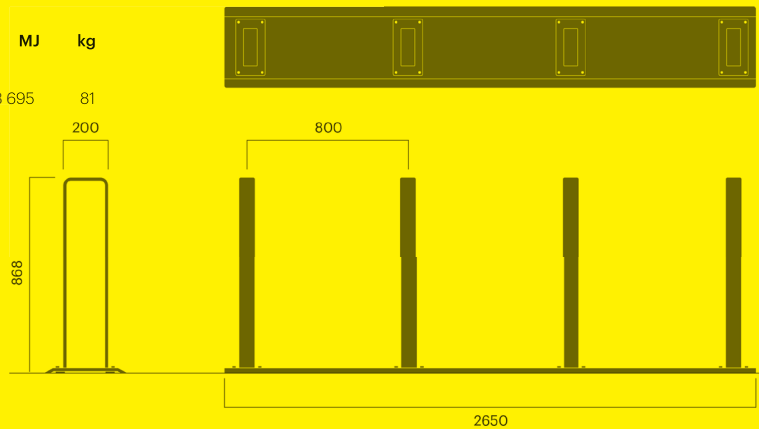

Ypsilon



Ypsilon Hockerbank

freistehend, Verankerung C		kg CO ₂ e	MJ	kg
Art. 6206-900	1 250 EUR	52	99	31
Art. 6206-901	1 040 EUR	52	99	30
Art. 6206-900C	1 250 EUR	56	1 057	33
Art. 6206-901C	1 040 EUR	56	1 057	30

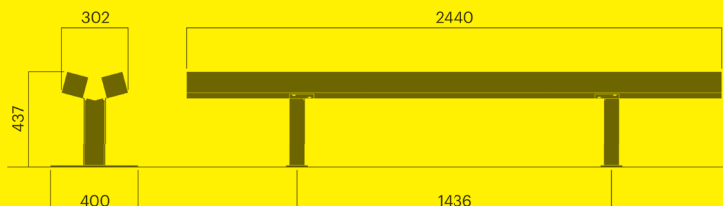

Ypsilon Hockerbank, mit Armlehne

freistehend, Verankerung C		kg CO ₂ e	MJ	kg
Art. 6207-900	1 480 EUR	64	1 168	35
Art. 6207-901	1 260 EUR	64	1 168	35
Art. 6207-900C	1 480 EUR	73	1 297	37
Art. 6207-901C	1 260 EUR	73	1 297	37

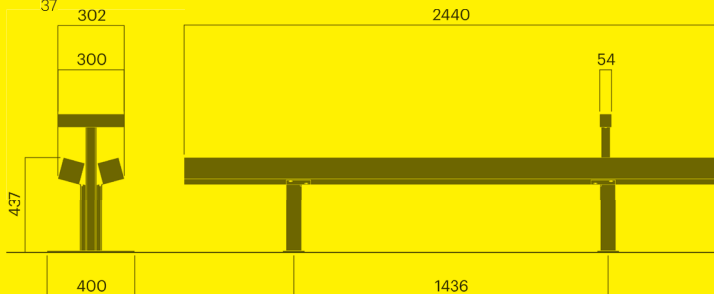

Ypsilon Bank

freistehend, Verankerung C		kg CO ₂ e	MJ	kg
Art. 6216-900	1 980 EUR	102	1 780	51
Art. 6216-901	1 760 EUR	102	1 780	51
Art. 6216-900C	1 980 EUR	153	2 492	59
Art. 6216-901C	1 760 EUR	153	2 492	59

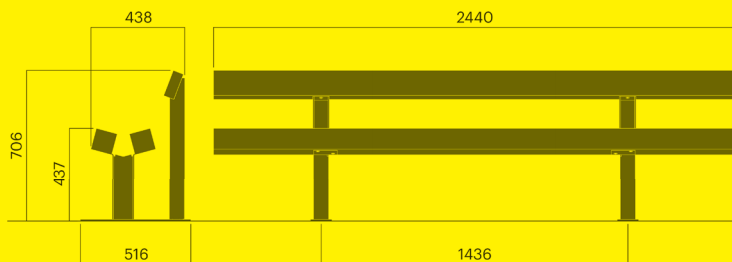

Ypsilon Bank, mit Armlehne

freistehend, Verankerung		kg CO ₂ e	MJ	kg
Art. 6217-900	2 360 EUR	114	1 949	55
Art. 6217-901	2 140 EUR	114	1 949	55
Art. 6217-900C	2 360 EUR	154	2 505	55
Art. 6217-901C	2 140 EUR	154	2 505	55

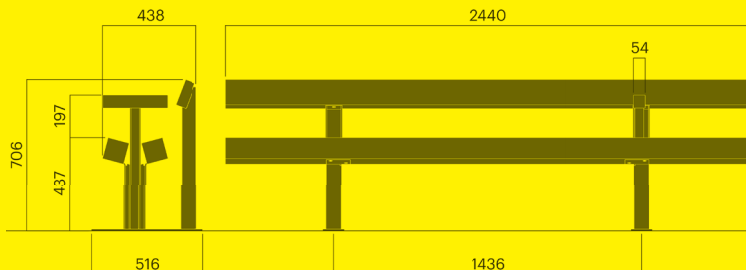

Ypsilon Kreisbank, ø2800

D2800 - Preis auf Anfrage		kg CO ₂ e	MJ	kg
Art. 6210-900C	7 230 EUR	-	-	-
Art. 6210-901C	6 730 EUR	-	-	-
Art. 6210-900	6 930 EUR	-	-	-
Art. 6210-901	6 480 EUR	-	-	-

D3500 - Preis auf Anfrage

Art. 6212-900C	-	-	-	-
Art. 6212-901C	-	-	-	-
Art. 6212-900	-	-	-	-
Art. 6212-901	-	-	-	-

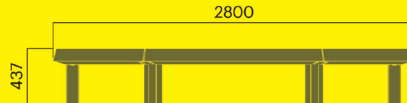
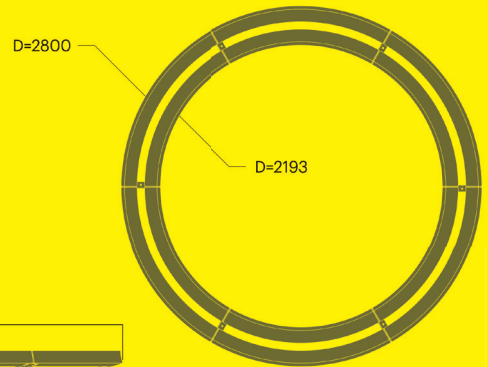

Ypsilon Ablagefläche, abnehmbar

		kg CO ₂ e	MJ	kg
Art. 6238-900	300 EUR	12	12	4
Art. 6238-901	250 EUR	164	164	4

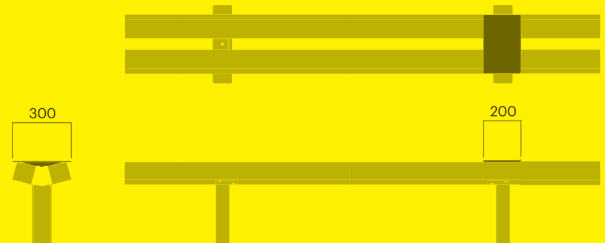



Zubehör Inbusschlüssel 14 mm

Art.	Preis	kg CO ₂ e	MJ	kg
Art. 90007-901	15 EUR	0	0	0

City Betonsockel

für City Abfallbehälter 70 Liter und 17/16 Liter		kg CO ₂ e	MJ	kg
Art. 267-004	90 EUR	6	220	28

für City Abfallbehälter 150 Liter und 180 Liter		kg CO ₂ e	MJ	kg
Art. 247-004	100 EUR	14	496	58

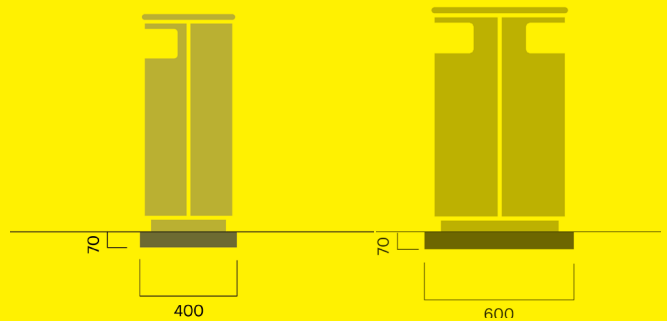

City Montagepfosten

Betonfundament für Montagepfosten 76/60		kg CO ₂ e	MJ	kg
Art. 193-004	40 EUR	6	212	0

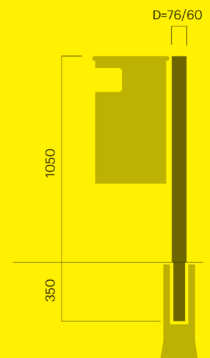

Anti-Graffiti

		kg CO ₂ e	MJ	kg
Art. Antigraffitibehandlung	200 EUR	-	-	0
Art. Feste for plantestøtte	310 EUR	-	-	0

Bewässerungssystem auf Anfrage. Entwässerungslöcher ohne Aufpreis möglich.

City Vogelabwehr

für 50/70 Liter		kg CO ₂ e	MJ	kg
Art. 201-902	120 EUR	11	200	0

für 150/180 Liter				
Art. 202-902	220 EUR	18	333	2

Bloc Abfallbehälter

Vogelschutz		kg CO ₂ e	MJ	kg
Art. 1540-902	310 EUR	0	0	2

USB Anschluss

Universelles Modell für Bänke		kg CO ₂ e	MJ	kg
Art. 90004-902	560 EUR	9	130	1



Haken zum Anheben

		kg CO ₂ e	MJ	kg
Art. Løftekroker	280 EUR	-	-	-

Norwegen

+47 23 00 78 40
post@vestre.com

Schweden

+46 (0)560 688877
info@vestre.com

Dänemark

+45 89 88 23 30
post@vestre.com

Großbritannien

+44 (0)207 846 8725
uk@vestre.com

Deutschland

+49 (0)30 407 417 95
de@vestre.com

Frankreich

+49 (0)30 407 417 95
de@vestre.com

Schweiz

+49 (0)30 407 417 95
de@vestre.com

Benelux

+49 (0)30 407 417 95
de@vestre.com

Österreich

+49 (0)30 407 417 95
de@vestre.com

USA

+1 212 634 9658
usa@vestre.com

globaler Export

international@vestre.com

Unsere Ansprechpartner:innen haben regionale Zuständigkeiten.
Hier finden Sie eine Aufstellung.

