

# Prisliste & teknisk informasjon

vestre

Alle priser er oppdatert i mai 2024, de er priset netto ekskl. mva. og frakt og gjelder standard utførelse. For møbler er standard utførelse linoljeimpregnert furu, med mindre annet er angitt. Det tas forbehold om prisendringer og trykkfeil. Bestilling er først bindende når ordren er bekreftet.

For oppdaterte priser, vennligst se [vestre.com](https://www.vestre.com).

Artikkellistene har følgende system:

**XXX-901:** Produktet er varmforsinket, noe som gir en grå overflate med varig rustbeskyttelse.

**XXX-900:** Produktet er varmforsinket og deretter pulverlakkert i valgfri RAL Classic-farge.

**XXX-902:** Produktet er fremstilt av rustfritt eller syrefast stål, noe som gir en elegant metalloverflate.

**XXX-904:** Produktet er fremstilt av aluminium og deretter pulverlakkert i valgfri RAL Classic-farge.

**XXX-XXXA:** Forankring med fotplate som skrues fast i underlaget.

**XXX-XXXB:** Forankring ved montering på vegg.

**XXX-XXXC:** Forankring ved nedstøp, med eller uten betongfundament (tillegg).

**XXX-XXXD:** Produktet kan demonteres midlertidig, for eksempel ved snørydding eller biltrafikk.

**XXX-XXXMK:** Produktet leveres uten ben og skal monteres direkte på murkant.

**XXX-XXXP:** Sete, rygg og/eller bordplate i perforert stål.

**XXX-XXXS:** Produktet er roterbart, for eksempel stoler og barstoler.

**XXX-XXXK:** Overgangsmodule.

**Kg CO2:** Produktets karbonfotavtrykk oppgitt i kg (A1–A3, fra råmateriale til ferdig produkt).

**MJ:** Den totale energibruken i produksjonen av produktet A1–A3. Målt i megajoule.

\* Indikerer at vi har brukt miljøverdiene fra et tilsvarende produkt.

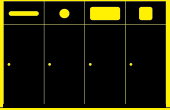

Acceptor 8



Air 10



April 11



April GO 22



Atlas 26



Berg 28



Berlin 29



Bloc 30



Boboli 43



Bøy 45



Briskeby 46

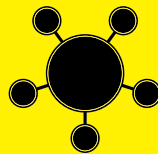

Buzz 47



City 49



Coast 53



Code 53



Corner 54

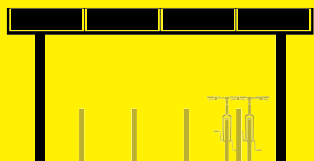

Cover 55



Cycle 55



Dialog 55



Edo 57



Folk 58



Forum 60



Hill 63



Hvilan 63

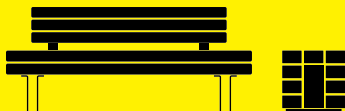

Kong 66



Kyoto 67



Move 68

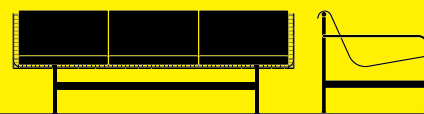

Munch 69

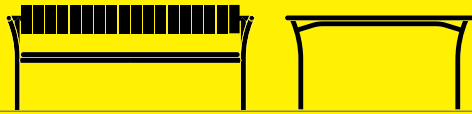

Parc 72

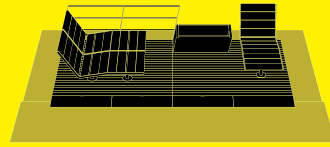

Parklets 2.0 73



Plinth 77

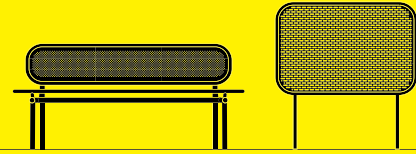

Pop 79



Porto 82



Reale 85



Sinus 87



Stones 88



Stoop 89



Stripes 90



Tour 93

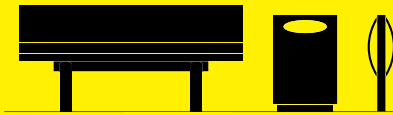

Urban 94



Vega 103

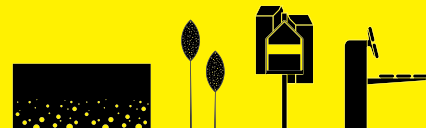

Vestre Habitats 104



Via 107

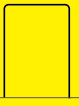

Vroom 111



Ypsilon 122



Tilbehør

125



## Acceptor 110 kildesortering

2 x 55 liter		kg CO <sub>2</sub> e	MJ	kg
Art. 2142-900	<b>16 900 NOK</b>	275	3 838	87
Art. 2142-901	<b>14 300 NOK</b>	275	3 838	87
1 x 110 liter		kg CO <sub>2</sub> e	MJ	kg
Art. 2144-900	<b>16 900 NOK</b>	278	3 875	88
Art. 2144-901	<b>14 300 NOK</b>	278	3 875	88

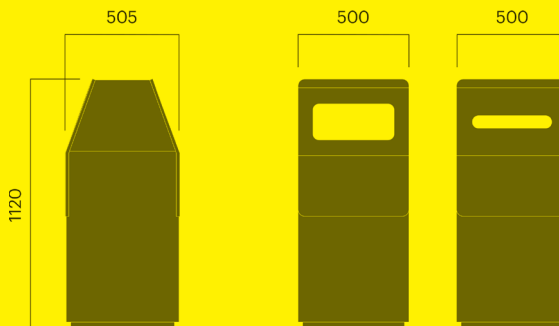

## Acceptor 110 kildesortering

3 x 110 liter		kg CO <sub>2</sub> e	MJ	kg
Art. 2192-900	<b>36 900 NOK</b>	739	10 746	173
Art. 2192-901	<b>31 900 NOK</b>	739	10 746	173

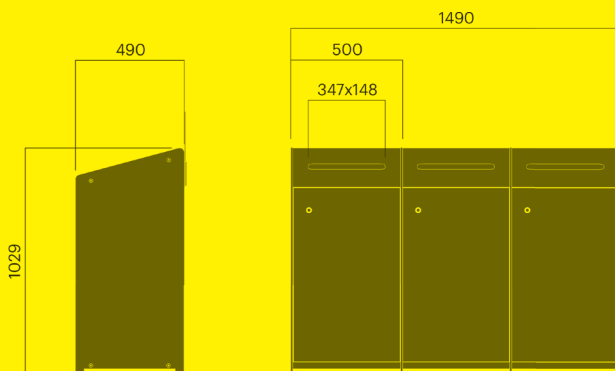

## Acceptor 160 kildesortering

2 x 160 liter		kg CO <sub>2</sub> e	MJ	kg
Art. 2145-900	<b>30 500 NOK</b>	486	6 779	155
Art. 2145-901	<b>25 100 NOK</b>	486	6 779	155

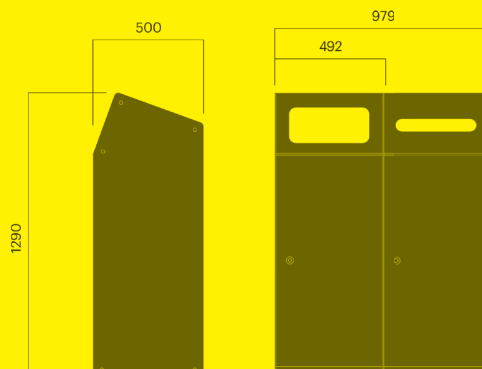

## Acceptor 160 kildesortering

3 x 160 liter		kg CO <sub>2</sub> e	MJ	kg
Art. 2146-900	45 500 NOK	679	9 473	219
Art. 2146-901	38 300 NOK	679	9 473	219

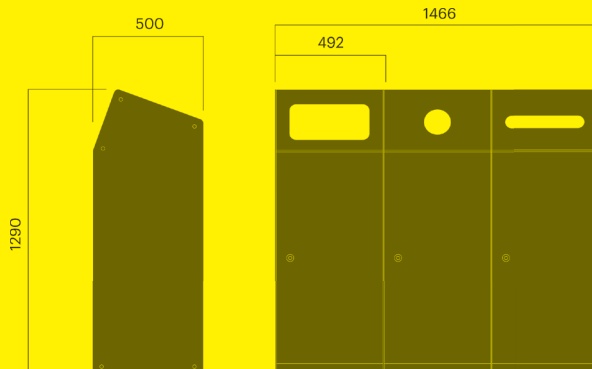

## Acceptor 160 kildesortering

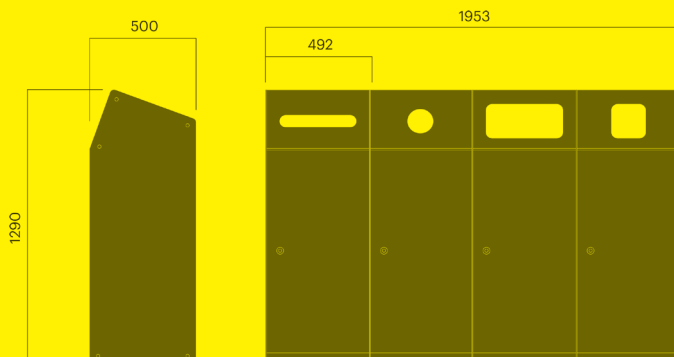

4 x 160 liter		kg CO <sub>2</sub> e	MJ	kg
Art. 2147-900	58 600 NOK	722	10 481	284
Art. 2147-901	51 100 NOK	722	10 481	284



## Acceptor innkast

Velg mellom forskjellige sorteringer og farger på innkast til Acceptor 160.

Vekt: 8 kg

2122A	2122B	2122C	2122D
			
<b>Kg CO<sub>2</sub>:</b> 22 <b>MJ:</b> 305	<b>Kg CO<sub>2</sub>:</b> 24 <b>MJ:</b> 328	<b>Kg CO<sub>2</sub>:</b> 24 <b>MJ:</b> 333	<b>Kg CO<sub>2</sub>:</b> 22 <b>MJ:</b> 305





## Air krakk

		kg CO <sub>2</sub> e	MJ	kg
Art. 3206-900	<b>11 700 NOK</b>	79	1 536	31
Art. 3206-901	<b>9 500 NOK</b>	79	1 536	31



## Air benk

		kg CO <sub>2</sub> e	MJ	kg
Art. 3217-900	<b>21 200 NOK</b>	171	2 740	71
Art. 3217-901	<b>19 500 NOK</b>	171	2 740	71

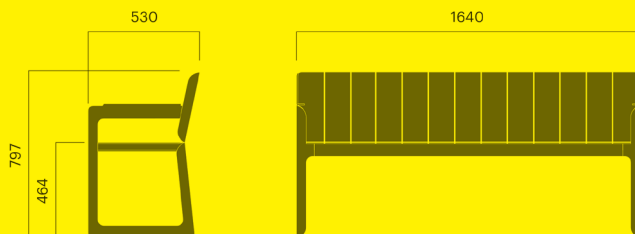

## Air bord

		kg CO <sub>2</sub> e	MJ	kg
Art. 3236-900	<b>15 800 NOK</b>	116	1 901	51
Art. 3236-901	<b>12 900 NOK</b>	116	1 901	51

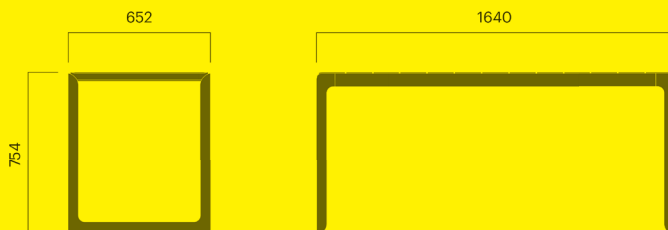



## Forankringsmuligheter

- A: fotplate
- B: vegg
- C: nedstøp
- MK: murkant

S: roterbar – se teknisk informasjon  
(+ 1 400 NOK)

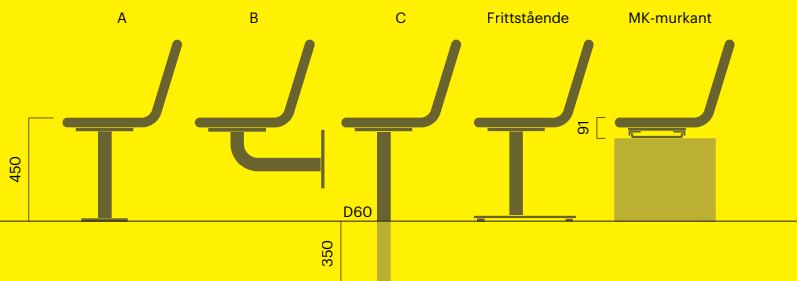

## April armlene

April benker og stoler kan leveres med tre ulike armlene.

Standard armlene

Armlenesett av tre  
F.eks. XXX-XXXWO

Universelt armlene  
(universell utforming)  
F.eks. XXX-XXX T

1 000 NOK  
Vekt: 1 kg

Kg CO<sub>2</sub>: 1  
MJ: 30



## April perforert

April benker, stoler og bord kan også leveres med rygg, sete og bordplate i perforert stål.

F.eks. XXX-XXX P

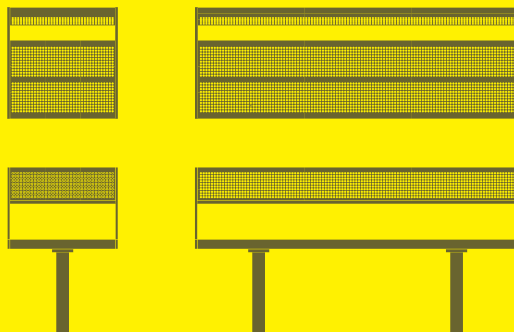

## April stol

Forankring A, B, C eller MK		kg CO <sub>2</sub> e	MJ	kg
Art. 70-900A	4 200 NOK	38	584	15
Art. 70-901A	3 700 NOK	38	584	15
Art. 70-900B	5 100 NOK	38	589	16
Art. 70-901B	4 700 NOK	38	589	16
Art. 70-900C	4 100 NOK	38	594	15
Art. 70-901C	3 600 NOK	38	594	15
Art. 70-900MK	4 200 NOK	26	420	11
Art. 70-901MK	3 600 NOK	26	420	11
<b>Frittstående</b>				
Art. 71-900	6 300 NOK	57	851	18
Art. 71-901	5 200 NOK	57	851	18

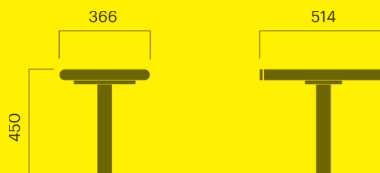

## April stol

Forankring A, B, C eller MK		kg CO <sub>2</sub> e	MJ	kg
Art. 74-900A	5 500 NOK	50	790	20
Art. 74-901A	4 700 NOK	50	790	20
Art. 74-900B	6 300 NOK	50	790	21
Art. 74-901B	5 600 NOK	50	790	21
Art. 74-900C	5 200 NOK	51	801	21
Art. 74-901C	4 500 NOK	51	801	21
Art. 74-900MK	5 100 NOK	39	631	17
Art. 74-901MK	4 500 NOK	39	631	17

### Frittstående

Art. 75-900	7 400 NOK	69	1 055	27
Art. 75-901	6 500 NOK	69	1 055	27

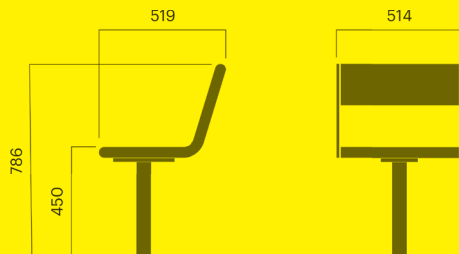

## April stol

Forankring A, B, C eller MK		kg CO <sub>2</sub> e	MJ	kg
Art. 76-900AT	6 100 NOK	69	1 055	27
Art. 76-901AT	5 200 NOK	69	1 055	27
Art. 76-900BT	7 100 NOK	69	1 057	27
Art. 76-901BT	6 000 NOK	69	1 057	27

### Forankring A, B, C eller MK

Art. 76-900CT	5 900 NOK	70	1 069	27
Art. 76-901CT	5 100 NOK	70	1 069	27
Art. 76-900MK	5 900 NOK	45	725	19
Art. 76-901MK	5 000 NOK	45	725	19

### Frittstående

Art. 77-900T	8 200 NOK	76	1 154	33
Art. 77-901T	7 100 NOK	76	1 154	33

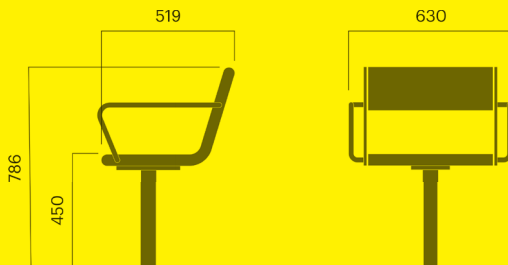

## April stol høy rygg

Uten armlene, forankring A eller C	kg CO <sub>2</sub> e	MJ	kg	
Art. 763-900A	9 300 NOK	71	1 244	35
Art. 763-901A	8 300 NOK	71	1 244	35
Art. 763-900C	9 100 NOK	73	1 267	36
Art. 763-901C	8 100 NOK	73	1 267	36

### Med armlene, forankring A eller C

Art. 764-900AT	11 600 NOK	91	1 520	41
Art. 764-901AT	10 500 NOK	91	1 520	41
Art. 764-900CT	11 300 NOK	93	1 544	42
Art. 764-901CT	10 300 NOK	93	1 544	42

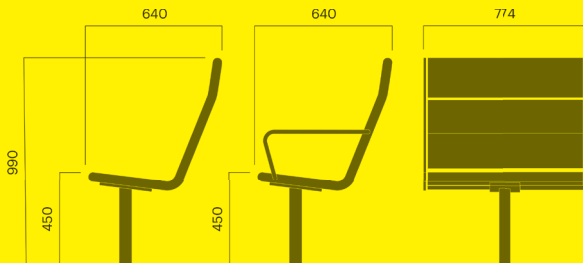

## April barstol

Forankring A, B, C eller MK		kg CO <sub>2</sub> e	MJ	kg
Art. 78-900A	<b>8 100 NOK</b>	70	1 085	28
Art. 78-901A	<b>7 600 NOK</b>	70	1 085	46
Art. 78-900C	<b>7 900 NOK</b>	71	1 100	27
Art. 78-901C	<b>7 400 NOK</b>	71	1 100	27

### Frittstående

Art. 78-900	<b>11 700 NOK</b>	129	1 902	42
Art. 78-901	<b>10 900 NOK</b>	129	1 902	46

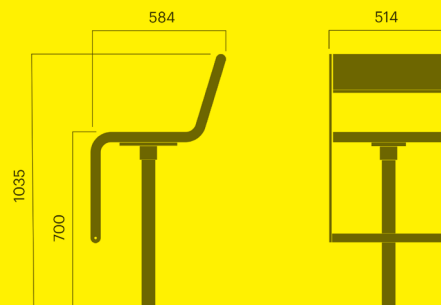

## April barstol

Forankring A, B, C eller MK		kg CO <sub>2</sub> e	MJ	kg
Art. 79-900A	<b>9 700 NOK</b>	38	584	26
Art. 79-901A	<b>8 500 NOK</b>	38	584	27
Art. 79-900C	<b>9 500 NOK</b>	38	594	27
Art. 79-901C	<b>8 200 NOK</b>	38	594	27

### Frittstående

Art. 79-900	<b>12 600 NOK</b>	125	1 845	44
Art. 79-901	<b>11 300 NOK</b>	125	1 845	44

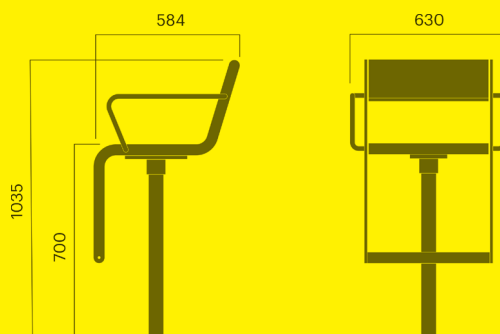

## April krakk

Forankring A, B, C eller MK		kg CO <sub>2</sub> e	MJ	kg
Art. 703-900A	<b>7 200 NOK</b>	67	1 134	31
Art. 703-901A	<b>6 100 NOK</b>	67	1 134	31
Art. 703-900B	<b>8 100 NOK</b>	70	1 170	32
Art. 703-901B	<b>7 100 NOK</b>	70	1 170	32
Art. 703-900C	<b>6 700 NOK</b>	69	1 162	32
Art. 703-901C	<b>5 700 NOK</b>	69	1 162	32
Art. 703-900MK	<b>6 300 NOK</b>	44	810	24
Art. 703-901MK	<b>5 500 NOK</b>	44	810	24

### Frittstående

Art. 706-900	<b>8 300 NOK</b>	76	1 260	34
Art. 706-901	<b>7 300 NOK</b>	76	1 260	34

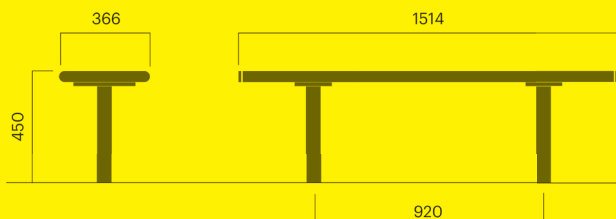

## April krakk

Forankring A, B, C eller MK		kg CO <sub>2</sub> e	MJ	kg
Art. 704-900A	10 500 NOK	77	1 265	34
Art. 704-901A	9 000 NOK	77	1 265	34
Art. 704-900B	11 700 NOK	79	1 303	35
Art. 704-901B	10 400 NOK	79	1 303	35
Art. 704-900C	10 100 NOK	77	1 265	35
Art. 704-901C	8 600 NOK	77	1 265	35
Art. 704-900MK	10 200 NOK	53	941	27
Art. 704-901MK	8 700 NOK	53	941	34

### Frittstående

Art. 707-900	11 700 NOK	86	1 396	37
Art. 707-901	10 600 NOK	86	1 396	37

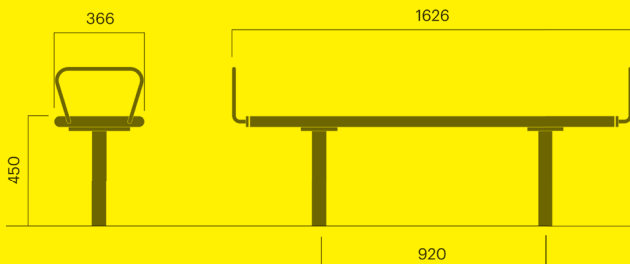

## April benk

Forankring A, B, C eller MK		kg CO <sub>2</sub> e	MJ	kg
Art. 713-900A	8 400 NOK	83	1 446	41
Art. 713-901A	7 400 NOK	83	1 446	41
Art. 713-900B	9 900 NOK	83	1 456	41
Art. 713-901B	8 700 NOK	83	1 456	41
Art. 713-900C	7 900 NOK	84	1 470	42
Art. 713-901C	6 900 NOK	84	1 470	42
Art. 713-900MK	8 200 NOK	51	799	34
Art. 713-901MK	6 800 NOK	51	799	34

### Frittstående

Art. 716-900	9 800 NOK	96	1 629	45
Art. 716-901	8 500 NOK	96	1 629	45

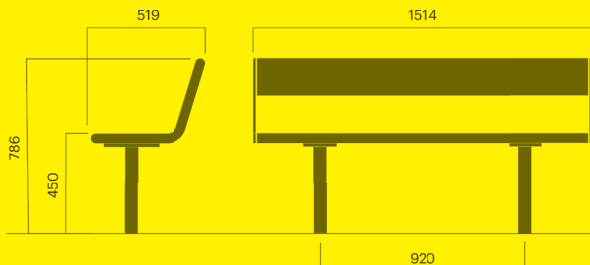

## April benk

Forankring A, B, C eller MK		kg CO <sub>2</sub> e	MJ	kg
Art. 714-900A	9 800 NOK	89	1 535	43
Art. 714-901A	8 300 NOK	89	1 535	43
Art. 714-900B	10 900 NOK	106	1 774	43
Art. 714-901B	9 200 NOK	106	1 774	43
Art. 714-900C	9 400 NOK	91	1 559	44
Art. 714-901C	7 900 NOK	91	1 559	44
Art. 714-900MK	8 900 NOK	59	1 118	36
Art. 714-901MK	7 400 NOK	59	1 118	36

### Frittstående

Art. 717-900	10 500 NOK	102	1 719	47
Art. 717-901	9 200 NOK	102	1 719	47

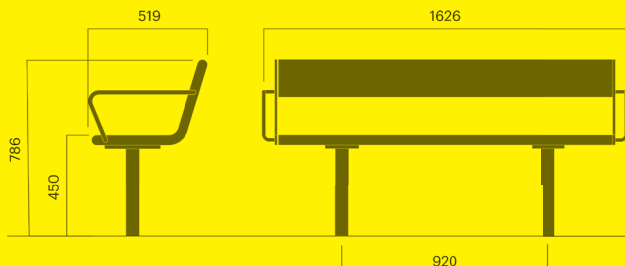

## April solbenk

Forankring A eller C		kg CO <sub>2</sub> e	MJ	kg
Art. 766-900A	<b>16 700 NOK</b>	149	2 588	72
Art. 766-901A	<b>14 900 NOK</b>	145	2 546	72
Art. 766-900C	<b>16 300 NOK</b>	149	2 588	73
Art. 766-901C	<b>14 400 NOK</b>	145	2 546	73

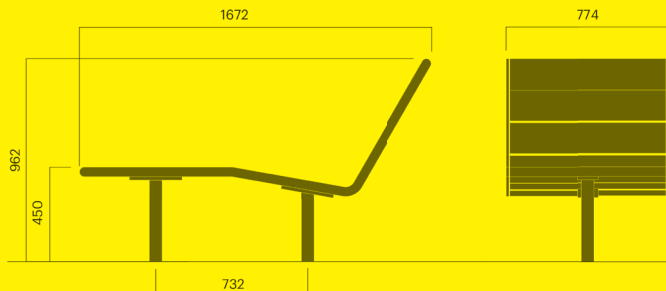

## April benk høy rygg

Forankring A eller C		kg CO <sub>2</sub> e	MJ	kg
Art. 768-900A	<b>14 100 NOK</b>	101	1 898	55
Art. 768-901A	<b>12 600 NOK</b>	101	1 898	56
Art. 768-900C	<b>13 700 NOK</b>	102	1 903	57
Art. 768-901C	<b>12 200 NOK</b>	102	1 903	57

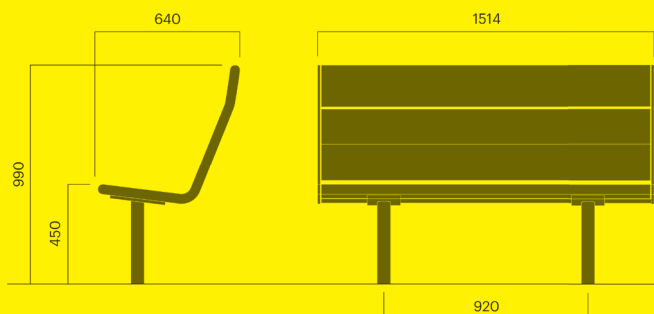

## April benk høy rygg

Forankring A eller C		kg CO <sub>2</sub> e	MJ	kg
Art. 769-900AT	<b>17 000 NOK</b>	118	2 128	62
Art. 769-901AT	<b>14 900 NOK</b>	118	2 128	62
Art. 769-900CT	<b>16 600 NOK</b>	121	2 180	63
Art. 769-901CT	<b>14 400 NOK</b>	121	2 180	63

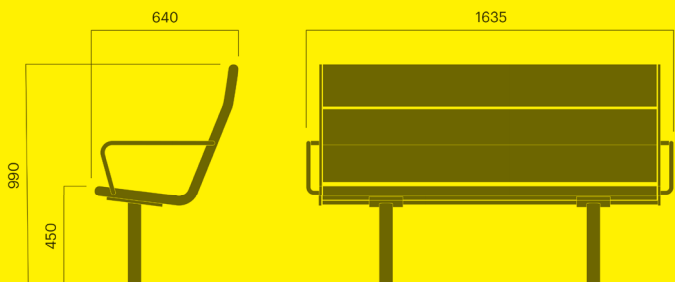

## April Stålbord

Lavt, forankring A eller C		kg CO <sub>2</sub> e	MJ	kg
Art. 732-900A	3 700 NOK	50	698	16
Art. 732-901A	3 200 NOK	50	698	16
Art. 732-900C	3 500 NOK	51	713	16
Art. 732-901C	3 000 NOK	51	713	16

### Høyt, forankring A eller C

Art. 730-900A	3 900 NOK	57	797	17
Art. 730-901A	3 200 NOK	57	797	17
Art. 730-900C	3 600 NOK	59	817	18
Art. 730-901C	3 000 NOK	59	817	18

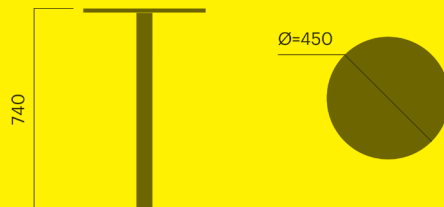

## April rundt bord lite

Forankring A eller C		kg CO <sub>2</sub> e	MJ	kg
Art. 731-900A	8 700 NOK	69	1 096	29
Art. 731-901A	7 900 NOK	69	1 096	29
Art. 731-900C	8 500 NOK	70	1 109	29
Art. 731-901C	7 700 NOK	70	1 109	29

### Frittstående

Art. 731-900	11 200 NOK	96	1 467	37
Art. 731-901	10 100 NOK	96	1 467	37

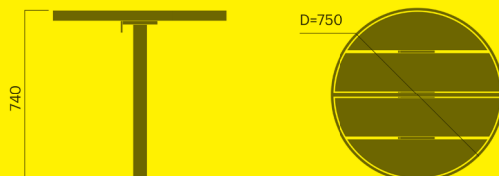

## April rundt bord

Forankring A eller C		kg CO <sub>2</sub> e	MJ	kg
Art. 737-900A	11 600 NOK	94	1 610	45
Art. 737-901A	10 500 NOK	94	1 610	45
Art. 737-900C	11 300 NOK	95	1 619	45
Art. 737-901C	10 300 NOK	95	1 619	45

### Frittstående

Art. 738-900	16 400 NOK	31	740	62
Art. 738-901	14 900 NOK	31	740	62

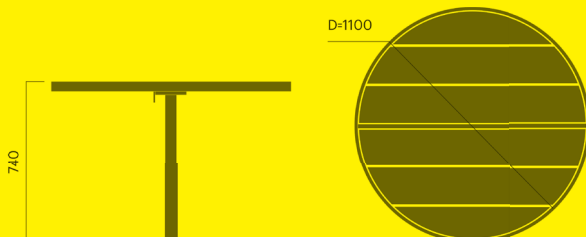

## April kvadratbord

Forankring A eller C		kg CO <sub>2</sub> e	MJ	kg
Art. 734-900A	6 800 NOK	66	1 091	30
Art. 734-901A	6 000 NOK	66	1 091	30
Art. 734-900C	6 600 NOK	67	1 100	30
Art. 734-901C	5 800 NOK	67	1 100	30

### Frittstående

Art. 735-900	9 200 NOK	92	1 457	38
Art. 735-901	8 300 NOK	92	1 457	38



## April standardbord

Forankring A eller C		kg CO <sub>2</sub> e	MJ	kg
Art. 733-900A	10 600 NOK	110	1 914	54
Art. 733-901A	9 100 NOK	110	1 914	54
Art. 733-900C	10 200 NOK	111	1 937	55
Art. 733-901C	8 700 NOK	111	1 937	55

### Frittstående

Art. 736-900	12 400 NOK	127	2 158	60
Art. 736-901	10 500 NOK	127	2 158	60

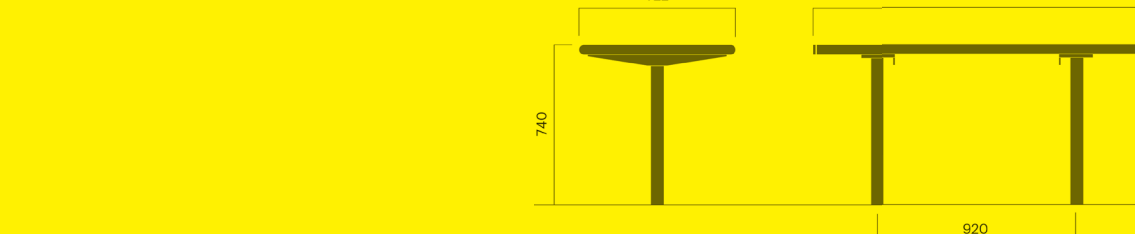

## April bord

### Tilpasset rullestol

Forankring A eller C		kg CO <sub>2</sub> e	MJ	kg
Art. 739-900A	11 300 NOK	112	1 979	57
Art. 739-901A	9 500 NOK	112	1 979	57
Art. 739-900C	10 900 NOK	114	2 007	58
Art. 739-901C	9 100 NOK	114	2 007	58

### Frittstående

Art. 739-900	12 700 NOK	130	2 227	63
Art. 739-901	10 800 NOK	130	2 227	63

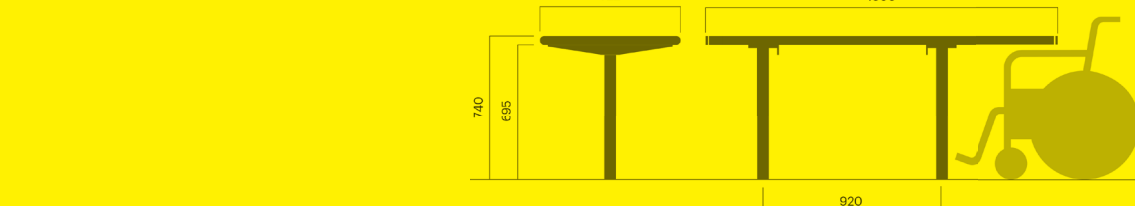



## April barbord

		kg CO <sub>2</sub> e	MJ	kg
Art. 741-900A	<b>9 100 NOK</b>	97	1 632	37
Art. 741-901A	<b>7 900 NOK</b>	97	1 632	36
Art. 741-900C	<b>8 800 NOK</b>	98	1 651	37
Art. 741-901C	<b>7 600 NOK</b>	98	1 651	37

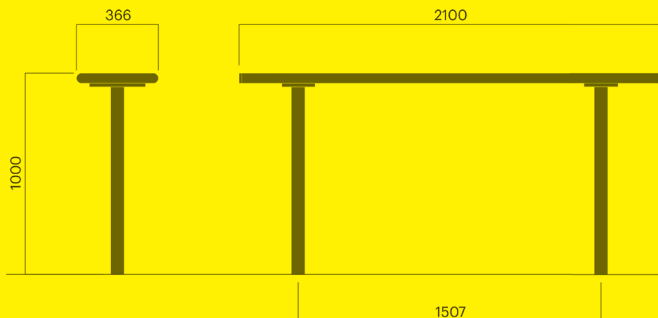

## April benkebord

Uten rygg		kg CO <sub>2</sub> e	MJ	kg
Art. 751-900	<b>25 100 NOK</b>	311	4 909	145
Art. 751-901	<b>22 600 NOK</b>	311	4 909	124

Rygg 1 side		kg CO <sub>2</sub> e	MJ	kg
Art. 753-900	<b>28 400 NOK</b>	326	5 412	154
Art. 753-901	<b>24 500 NOK</b>	326	5 412	148

Rygg på begge sider		kg CO <sub>2</sub> e	MJ	kg
Art. 752-900	<b>31 700 NOK</b>	339	5 631	164
Art. 752-901	<b>26 300 NOK</b>	339	5 631	158

Rygg 1 side og ekstra plass til rullestol		kg CO <sub>2</sub> e	MJ	kg
Art. 753-900H	<b>32 000 NOK</b>	344	5 794	157
Art. 753-901H	<b>26 600 NOK</b>	344	5 794	161

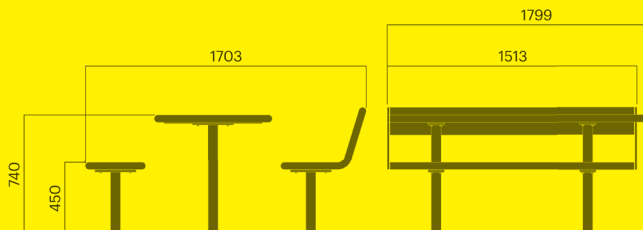

## April avfallsbeholder

75 liter		kg CO <sub>2</sub> e	MJ	kg
Art. 780-900	<b>12 600 NOK</b>	112	1 574	35
Art. 780-901	<b>10 600 NOK</b>	112	1 574	35

95 liter		kg CO <sub>2</sub> e	MJ	kg
Art. 782-900	<b>13 800 NOK</b>	128	1 791	40
Art. 782-901	<b>11 700 NOK</b>	128	1 791	40

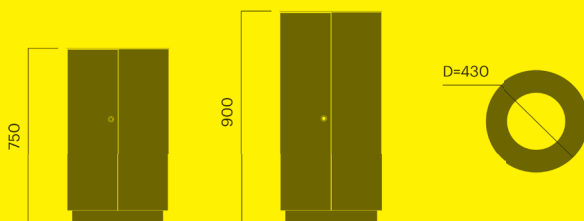

## April avfallsbeholder

145 liter		kg CO <sub>2</sub> e	MJ	kg
Art. 784-900	<b>15 800 NOK</b>	154	2 153	49
Art. 784-901	<b>13 700 NOK</b>	154	2 153	48
175 liter				
Art. 786-900	<b>17 800 NOK</b>	176	2 450	60
Art. 786-901	<b>15 200 NOK</b>	176	2 450	60

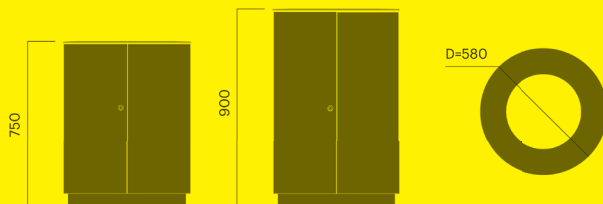

## April avfallsbeholder

75 liter		kg CO <sub>2</sub> e	MJ	kg
Art. 770-900	<b>16 900 NOK</b>	184	2 572	39
Art. 770-901	<b>15 200 NOK</b>	184	2 572	39
95 liter				
Art. 772-900	<b>18 000 NOK</b>	237	3 307	48
Art. 772-901	<b>16 300 NOK</b>	237	3 307	48

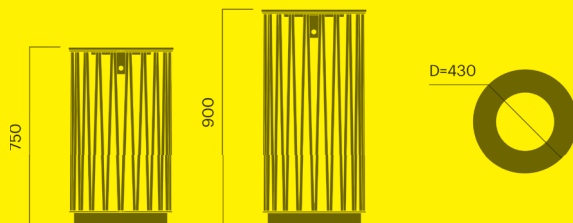

## April avfallsbeholder

145 liter		kg CO <sub>2</sub> e	MJ	kg
Art. 774-900	<b>19 500 NOK</b>	180	2 514	56
Art. 774-901	<b>17 500 NOK</b>	180	2 514	55
175 liter				
Art. 776-900	<b>20 500 NOK</b>	325	4 541	67
Art. 776-901	<b>18 700 NOK</b>	325	4 541	67

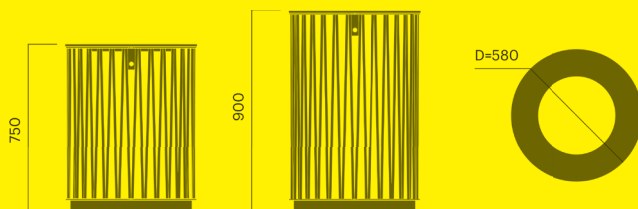

## April Stavanger krakk

Forankring A, B, C eller MK		kg CO <sub>2</sub> e	MJ	kg
Art. 720-900A	7 700 NOK	72	1 204	32
Art. 720-901A	6 600 NOK	72	1 204	32
Art. 720-900B	8 500 NOK	72	1 204	33
Art. 720-901B	7 400 NOK	72	1 204	33
Art. 720-900C	7 300 NOK	72	1 204	33
Art. 720-901C	6 200 NOK	72	1 204	33
Art. 720-900MK	7 000 NOK	47	852	25
Art. 720-901MK	5 900 NOK	47	852	25

### Frittstående

Art. 721-900	8 900 NOK	79	1 298	35
Art. 721-901	7 800 NOK	79	1 298	35

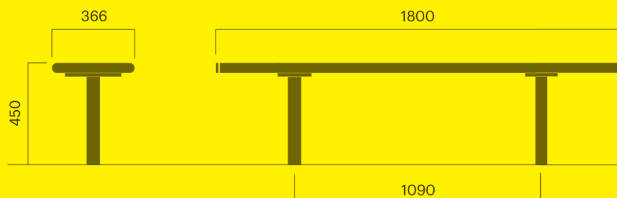

## April Stavanger krakk

Forankring A, B, C eller MK		kg CO <sub>2</sub> e	MJ	kg
Art. 722-900A	10 000 NOK	86	1 406	36
Art. 722-901A	9 000 NOK	86	1 406	36
Art. 722-900B	10 500 NOK	88	1 434	36
Art. 722-901B	9 500 NOK	88	1 434	36
Art. 722-900C	9 500 NOK	88	1 434	36
Art. 722-901C	8 600 NOK	88	1 335	36
Art. 722-900MK	9 300 NOK	55	974	36
Art. 722-901MK	8 600 NOK	55	974	36

### Frittstående

Art. 722-900	11 300 NOK	88	1 434	50
Art. 722-901	10 300 NOK	88	1 434	50

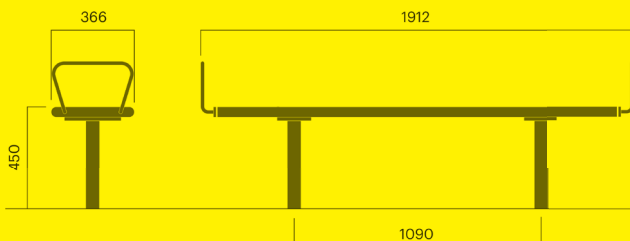

## April Stavanger benk

Forankring A, B, C eller MK		kg CO <sub>2</sub> e	MJ	kg
Art. 723-900A	9 800 NOK	86	1 553	45
Art. 723-901A	8 300 NOK	86	1 553	45
Art. 723-900B	11 000 NOK	87	1 557	45
Art. 723-901B	9 400 NOK	87	1 557	45
Art. 723-900C	9 400 NOK	88	1 576	46
Art. 723-901C	7 900 NOK	88	1 576	46
Art. 723-900MK	8 900 NOK	63	1 224	38
Art. 723-901MK	7 700 NOK	63	1 224	38

### Frittstående

Art. 726-900	10 600 NOK	99	1 735	49
Art. 726-901	9 300 NOK	99	1 735	49

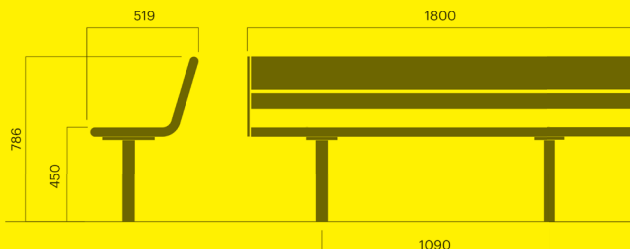

## April Stavanger benk

Forankring A, B, C eller MK		kg CO <sub>2</sub> e	MJ	kg
Art. 724-900A	11 300 NOK	93	1 646	47
Art. 724-901A	9 500 NOK	93	1 646	47
Art. 724-900B	12 000 NOK	93	1 646	47
Art. 724-901B	11 300 NOK	93	1 646	47
Art. 724-900C	10 900 NOK	95	1 679	48
Art. 724-901C	9 100 NOK	95	1 679	48
Art. 724-900MK	10 900 NOK	69	1 313	40
Art. 724-901MK	9 100 NOK	69	1 313	40

### Frittstående

Art. 727-900	12 700 NOK	105	1 820	51
Art. 727-901	11 200 NOK	105	1 820	70

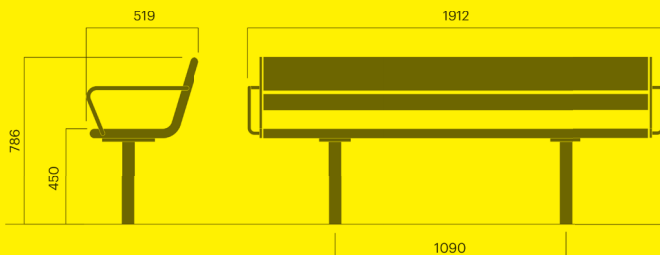

## April Stavanger bord

Forankring A eller C		kg CO <sub>2</sub> e	MJ	kg
Art. 743-900A	10 600 NOK	112	1 979	57
Art. 743-901A	9 400 NOK	112	1 979	57
Art. 743-900C	10 200 NOK	114	2 003	57
Art. 743-901C	9 000 NOK	114	2 003	57

### Frittstående

Art. 746-900	12 400 NOK	129	2 223	62
Art. 746-901	10 600 NOK	129	2 223	62

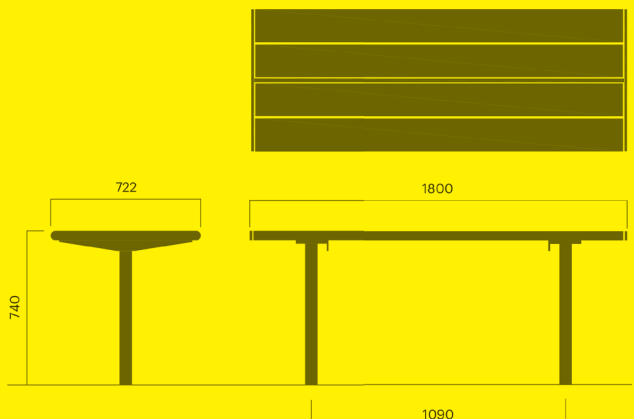

## April benkebord

Uten rygg		kg CO <sub>2</sub> e	MJ	kg
Art. 755-900	28 800 NOK	317	5 248	149
Art. 755-901	24 400 NOK	317	5 248	143

### Rygg 1 side

Art. 757-900	30 800 NOK	326	5 230	162
Art. 757-901	27 600 NOK	326	5 230	156

### Rygg begge sider

Art. 756-900	31 900 NOK	341	5 549	174
Art. 756-901	28 700 NOK	341	5 549	181

### Uten rygg barnehøyde 360/550

Art. 755-900JR	27 700 NOK	317	5 248	139
Art. 755-901JR	23 300 NOK	317	5 248	142

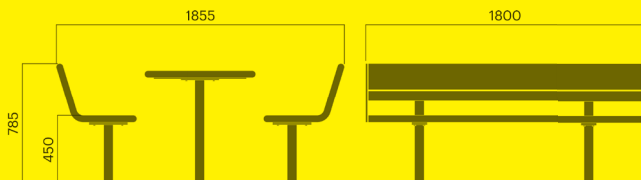



## April Go stol

Sete og rygg av lakkert aluminium	kg CO <sub>2</sub> e	MJ	kg	
Art. 7013-330	4 800 NOK	37	553	13
Art. 7013-331	4 000 NOK	37	553	13

### Sete og rygg av tre

Art. 7013-900	4 600 NOK	30	448	13
Art. 7013-901	4 000 NOK	30	448	11

### Stabelbar

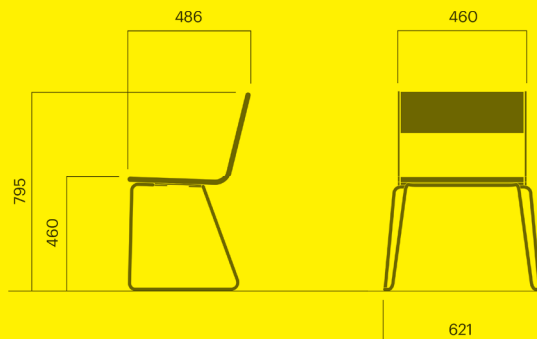

## April Go stol

Sete og rygg av lakkert aluminium	kg CO <sub>2</sub> e	MJ	kg	
Art. 7014-330	5 900 NOK	40	612	14
Art. 7014-331	5 200 NOK	40	612	14

### Sete og rygg av tre

Art. 7014-900	5 800 NOK	33	500	14
Art. 7014-901	5 300 NOK	33	500	13

### Stabelbar

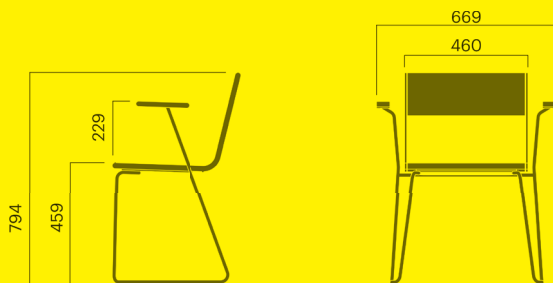

## April Go loungestol

Sete og rygg av tre		kg CO <sub>2</sub> e	MJ	kg
Art. 7064-900	<b>6 500 NOK</b>	32	485	12
Art. 7064-901	<b>5 200 NOK</b>	32	485	13

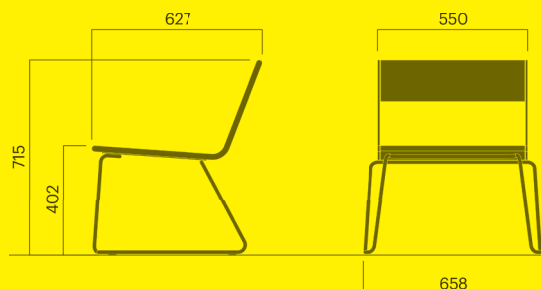

## April Go barstol

Sete og rygg av tre		kg CO <sub>2</sub> e	MJ	kg
Art. 7018-900	<b>6 800 NOK</b>	32	475	14
Art. 7018-901	<b>4 700 NOK</b>	32	475	14

Stabelbar

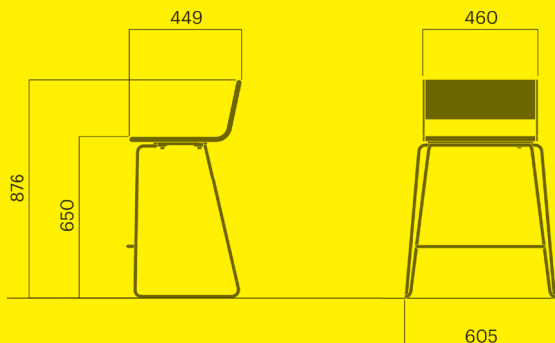

## April Go krakk

Sete og rygg av lakkert aluminium		kg CO <sub>2</sub> e	MJ	kg
Art. 7006-330	<b>5 500 NOK</b>	36	572	15
Art. 7006-331	<b>5 100 NOK</b>	36	572	15

Sete av tre

Art. 7006-900	<b>6 100 NOK</b>	36	572	15
Art. 7006-901	<b>5 300 NOK</b>	36	572	16

Stabelbar

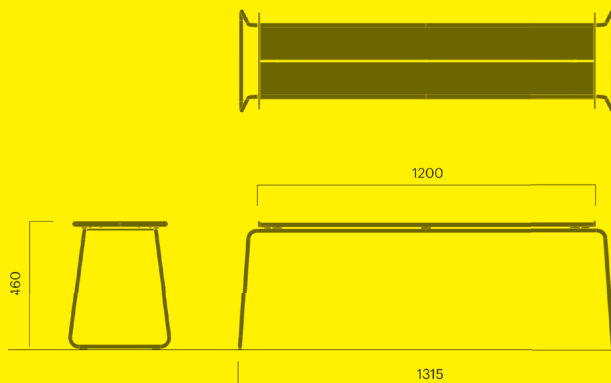

## April Go benk

		kg CO <sub>2</sub> e	MJ	kg
<b>Sete og rygg av lakkert aluminium</b>				
Art. 7015-330	<b>7 300 NOK</b>	60	922	22
Art. 7015-331	<b>6 100 NOK</b>	60	922	22

### Sete og rygg av tre

Art. 7015-900	<b>7 800 NOK</b>	44	708	18
Art. 7015-901	<b>6 700 NOK</b>	44	708	18

### Sete og rygg av tre med armlene

Art. 7016-900	<b>9 400 NOK</b>	47	760	19
Art. 7016-901	<b>8 300 NOK</b>	47	760	19

Stabelbar

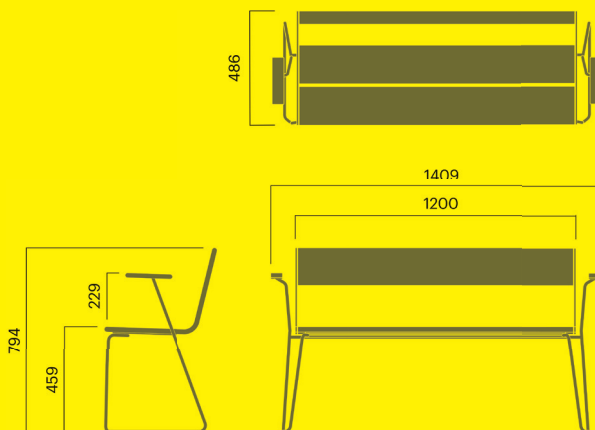

## April Go klappbord

		kg CO <sub>2</sub> e	MJ	kg
<b>Bordplate av tre</b>				
Art. 7033-900	<b>8 200 NOK</b>	38	503	13
Art. 7033-901	<b>7 200 NOK</b>	38	503	12

### Bordplate av lakkert aluminium

Art. 7033-330	<b>11 200 NOK</b>	50	777	16
Art. 7033-331	<b>10 200 NOK</b>	50	777	20

Sammenleggbar

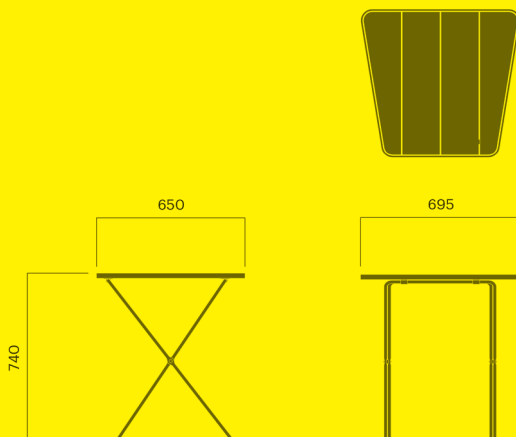

## April Go rundt klappbord

		kg CO <sub>2</sub> e	MJ	kg
<b>Bordplate av tre</b>				
Art. 7037-900	<b>10 800 NOK</b>	47	752	24
Art. 7037-901	<b>9 400 NOK</b>	47	752	24

Sammenleggbar

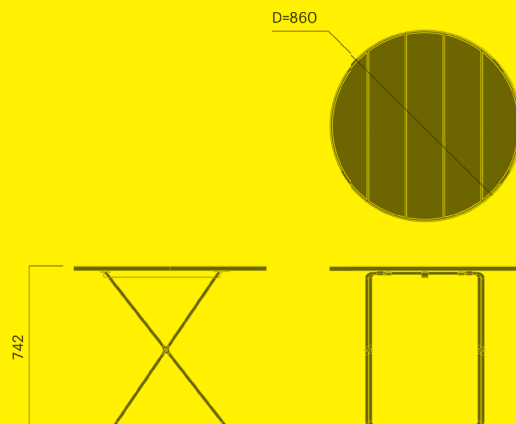

## April Go rektangulært klappbord

Bordplate av tre		kg CO <sub>2</sub> e	MJ	kg
Art. 7036-330	12 000 NOK	64	1 198	36
Art. 7036-331	10 800 NOK	64	1 198	36
Art. 7036-900	11 800 NOK	64	1 198	27
Art. 7036-901	9 800 NOK	64	1 198	27

Sammenleggbar

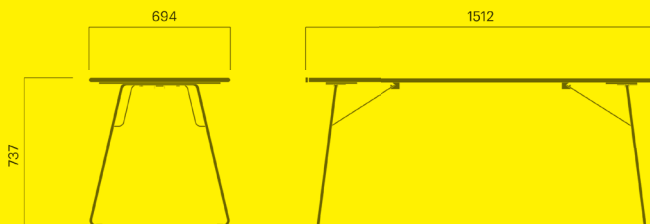

## April Go loungebord

Bordplate av tre		kg CO <sub>2</sub> e	MJ	kg
Art. 7030-900	5 800 NOK	37	544	15
Art. 7030-901	4 600 NOK	37	544	15



## April Go plantekasse

H390/D650, 100 liter		kg CO <sub>2</sub> e	MJ	kg
Art. 7080-900	8 700 NOK	86	1 202	29
Art. 7080-901	7 800 NOK	86	1 202	29

H570/D650, 150 liter		kg CO <sub>2</sub> e	MJ	kg
Art. 7081-900	9 400 NOK	131	1 818	38
Art. 7081-901	8 300 NOK	131	1 818	38

H790/D650, 210 liter		kg CO <sub>2</sub> e	MJ	kg
Art. 7082-900	10 800 NOK	162	2 257	60
Art. 7082-901	9 600 NOK	162	2 257	60

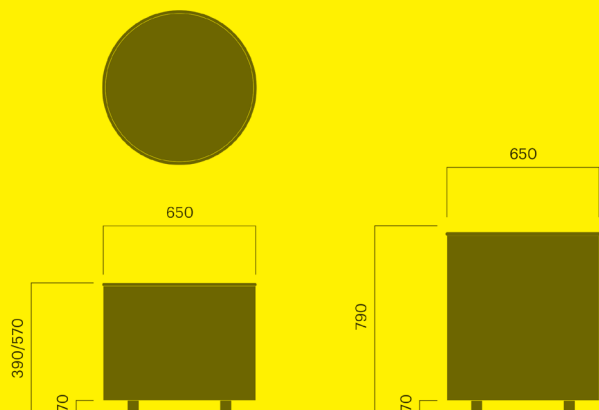



## April Go plantekasse

H390/D900, 150 liter		kg CO <sub>2</sub> e	MJ	kg
Art. 7083-900	<b>9 700 NOK</b>	165	2 300	49
Art. 7083-901	<b>8 600 NOK</b>	165	2 300	49

### H570/D900, 300 liter

Art. 7084-900	<b>13 800 NOK</b>	201	2 805	74
Art. 7084-901	<b>11 500 NOK</b>	201	2 805	74

### H820/D900, 460 liter

Art. 7085-900	<b>16 900 NOK</b>	220	3 069	71
Art. 7085-901	<b>15 600 NOK</b>	220	3 069	70

### H840/D2100, 800 liter

Art. 7087-900	<b>26 800 NOK</b>	498	6 930	168
Art. 7087-901	<b>23 800 NOK</b>	498	6 930	168

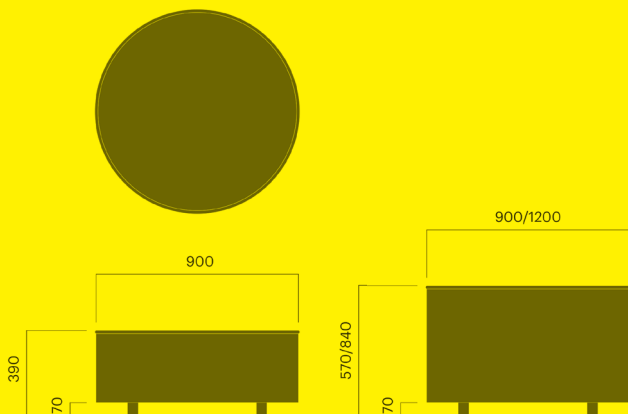

## Atlas



### Atlas krakk

2-seter		kg CO <sub>2</sub> e	MJ	kg
Art. 4502-900	<b>17 600 NOK</b>	159	2 007	70
Art. 4502-901	<b>14 800 NOK</b>	159	2 007	70

### 3-seter

Art. 4503-900	<b>24 100 NOK</b>	225	3 394	84
Art. 4503-901	<b>20 400 NOK</b>	225	3 394	84

### 4-seter

Art. 4504-900	<b>31 100 NOK</b>	290	4 392	130
Art. 4504-901	<b>26 400 NOK</b>	290	4 392	130

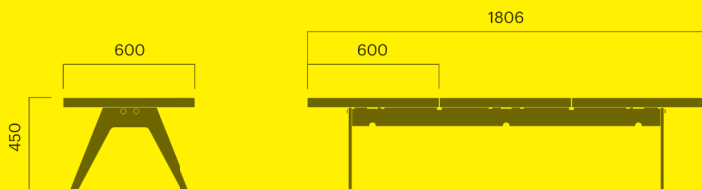

## Atlas benk

		kg CO <sub>2</sub> e	MJ	kg
<b>2-seter</b>				
Art. 4512-900	25 500 NOK	235	3 725	90
Art. 4512-901	23 500 NOK	235	3 725	90
<b>3-seter</b>				
Art. 4513-900	35 800 NOK	198	2 982	133
Art. 4513-901	33 500 NOK	198	2 982	133
<b>4-seter</b>				
Art. 4514-900	46 800 NOK	434	6 937	174
Art. 4514-901	43 900 NOK	434	6 937	174

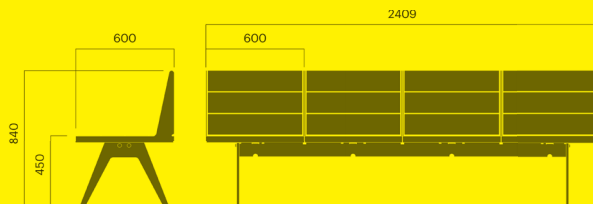

## Atlas dobbelbenk

		kg CO <sub>2</sub> e	MJ	kg
Art. 4527-900	61 400 NOK	589	9 283	240
Art. 4527-901	57 700 NOK	589	9 283	240
<b>Med 2 armlener</b>				
Art. 4528-900	66 300 NOK	620	9 710	252
Art. 4528-901	61 200 NOK	620	9 710	252

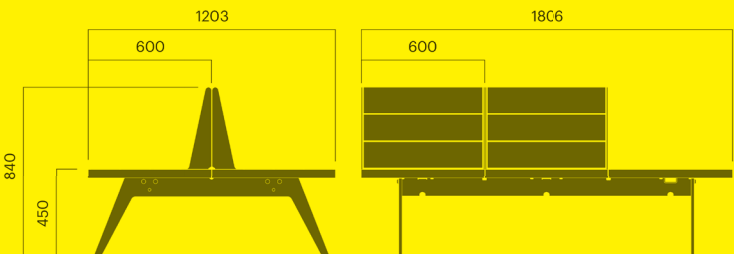

## Atlas sete

		kg CO <sub>2</sub> e	MJ	kg
<b>Sete uten rygg</b>				
Art. 4520-900	5 500 NOK	31	523	14
Art. 4520-901	4 700 NOK	31	523	14
<b>Buet sete</b>				
Art. 4530-900	11 000 NOK	86	1 391	37
Art. 4530-901	10 300 NOK	86	1 391	37

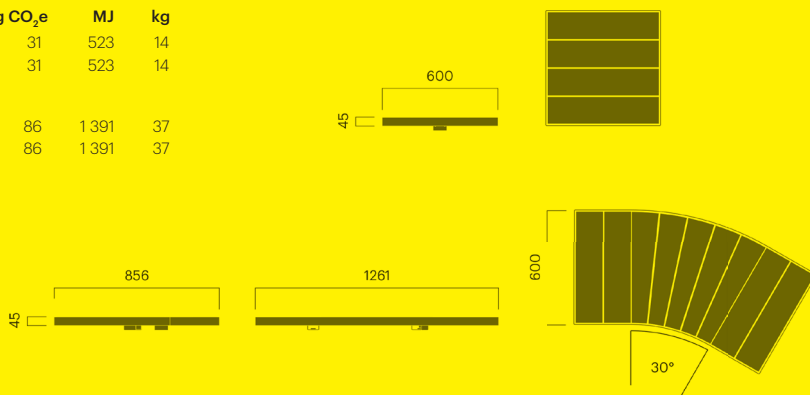

## Atlas sete med rygg

		kg CO <sub>2</sub> e	MJ	kg
Art. 4521-900	9 400 NOK	67	1 157	33
Art. 4521-901	9 100 NOK	67	1 157	33

### Med armene venstre (V) eller høyre (H)

Art. 4526-900V	11 100 NOK	83	1 392	38
Art. 4526-901V	10 300 NOK	83	1 392	38
Art. 4526-900H	11 100 NOK	83	1 392	38
Art. 4526-901H	10 300 NOK	83	1 392	38

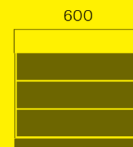
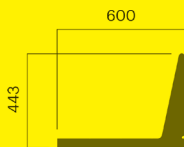

## Atlas understell

		kg CO <sub>2</sub> e	MJ	kg
<b>Understell 2-seter</b>				
Art. 4550-900	6 600 NOK	101	1 407	32
Art. 4550-901	5 400 NOK	101	1 407	32

<b>Understell 3-seter</b>				
Art. 4551-900	7 600 NOK	131	1 864	41
Art. 4551-901	6 300 NOK	131	1 864	41

<b>Understell 4-seter</b>				
Art. 4552-900	9 200 NOK	165	2 296	52
Art. 4552-901	7 600 NOK	165	2 296	52

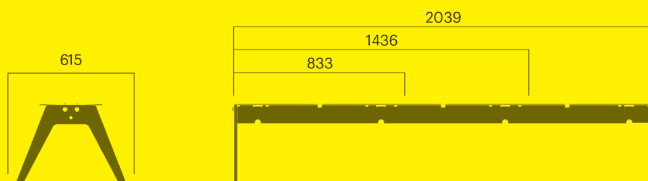
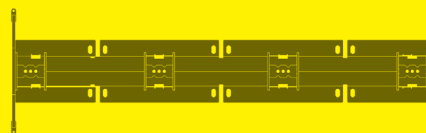

## Atlas understell

		kg CO <sub>2</sub> e	MJ	kg
<b>Understell 4-seter (2+2)</b>				
Art. 4560-900	11 000 NOK	193	2 697	63
Art. 4560-901	9 600 NOK	193	2 697	63

<b>Understell 6-seter (3+3)</b>				
Art. 4561-900	13 900 NOK	258	3 593	82
Art. 4561-901	11 400 NOK	258	3 593	82

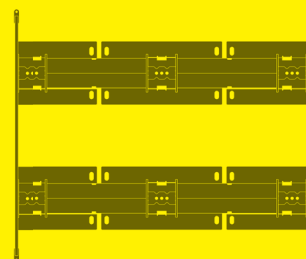



## Berg benkebord

		kg CO <sub>2</sub> e	MJ	kg
Art. 322-900	<b>17 900 NOK</b>	106	1 934	58
Art. 322-901	<b>15 900 NOK</b>	106	1 934	58
<b>Med plass for rullestol</b>				
Art. 322-900HC	<b>18 900 NOK</b>	136	2 465	65
Art. 322-901HC	<b>16 900 NOK</b>	136	2 465	65

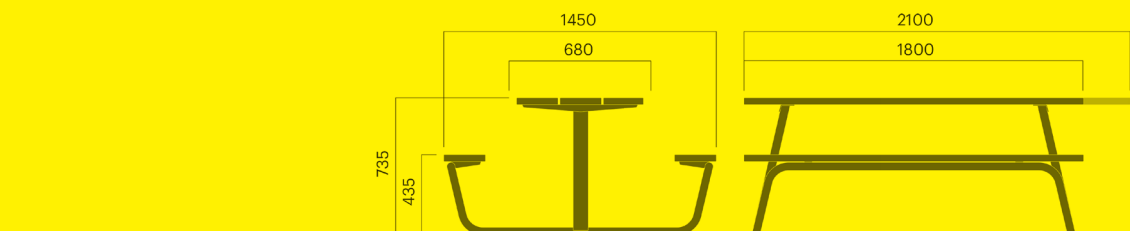

## Berg sykkelstativ

		kg CO <sub>2</sub> e	MJ	kg
<b>For 6 sykler</b>				
Art. 393-900	<b>8 900 NOK</b>	110	1 534	30
Art. 393-901	<b>7 400 NOK</b>	110	1 534	30
<b>For 8 sykler</b>				
Art. 395-900	<b>10 900 NOK</b>	150	2 083	42
Art. 395-901	<b>9 500 NOK</b>	150	2 083	42

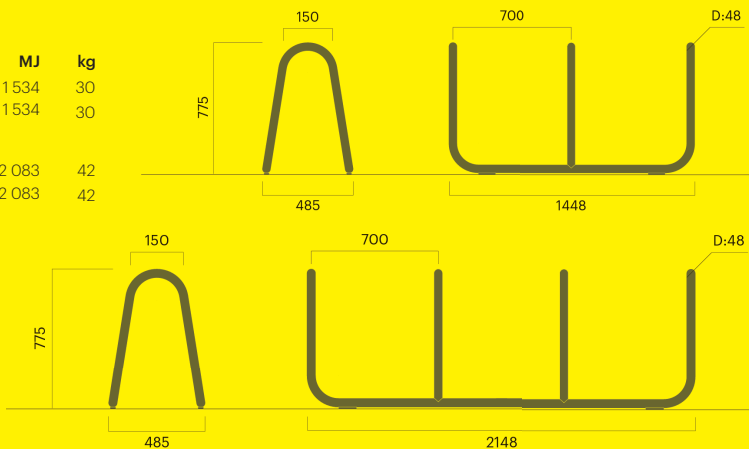

# Berlin



## Berlin stol

Forankring A eller C		kg CO <sub>2</sub> e	MJ	kg
Art. 3713-900A	12 000 NOK	74	1150	28
Art. 3713-901A	10 900 NOK	74	1150	26
Art. 3713-900C	11 700 NOK	77	1192	30
Art. 3713-901C	10 500 NOK	77	1192	30

### Forankring A eller C med armlene

Art. 3717-900A	13 800 NOK	90	1371	35
Art. 3717-901A	12 700 NOK	90	1371	35
Art. 3717-900C	13 500 NOK	92	1398	34
Art. 3717-901C	12 400 NOK	92	1398	34

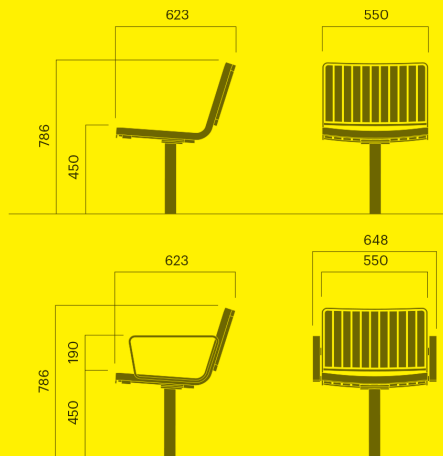

## Berlin stol

Frittstående		kg CO <sub>2</sub> e	MJ	kg
Art. 3718-900	14 600 NOK	93	1405	32
Art. 3718-901	13 400 NOK	93	1405	32

### Frittstående med armlene

Art. 3717-900	15 600 NOK	97	1464	36
Art. 3717-901	14 100 NOK	97	1464	36

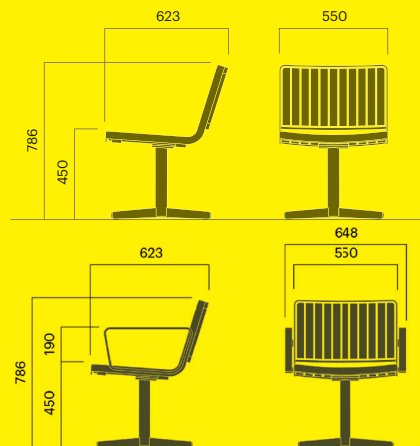

## Berlin bord lite

Forankring A eller C		kg CO <sub>2</sub> e	MJ	kg
Art. 3731-900A	6 300 NOK	64	896	22
Art. 3731-901A	5 200 NOK	64	896	20
Art. 3731-900C	6 100 NOK	65	905	20
Art. 3731-901C	5 000 NOK	65	905	20

### Frittstående

Art. 3731-900	7 400 NOK	72	999	22
Art. 3731-901	6 300 NOK	72	999	21

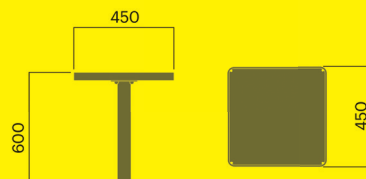

## Berlin bord stort

Forankring A eller C		kg CO <sub>2</sub> e	MJ	kg
Art. 3733-900A	<b>9 500 NOK</b>	141	1 965	45
Art. 3733-901A	<b>8 500 NOK</b>	141	1 965	45
Art. 3733-900C	<b>9 300 NOK</b>	142	1 975	44
Art. 3733-901C	<b>8 200 NOK</b>	142	1 975	45

### Frittstående

Art. 3733-900	<b>10 600 NOK</b>	147	2 054	47
Art. 3733-901	<b>9 400 NOK</b>	147	2 054	47

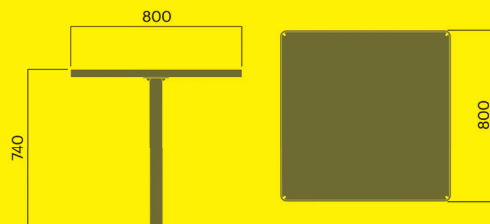

## Bloc



### Bloc stol

		kg CO <sub>2</sub> e	MJ	kg
Art. 1503-900	<b>12 600 NOK</b>	180	2 672	65
Art. 1503-901	<b>10 500 NOK</b>	180	2 672	65
<b>Med armene</b>				
Art. 1504-900	<b>13 800 NOK</b>	199	2 934	71
Art. 1504-901	<b>11 200 NOK</b>	199	2 934	71

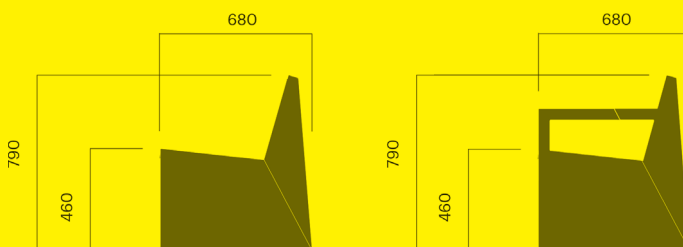
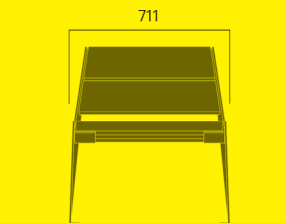

## Bloc barstol utan rygg

		kg CO <sub>2</sub> e	MJ	kg
Art. 1521-900	12 800 NOK	144	2 285	62
Art. 1521-901	11 400 NOK	144	2 285	62

\* GWP & MJ proxy based on 1506-900

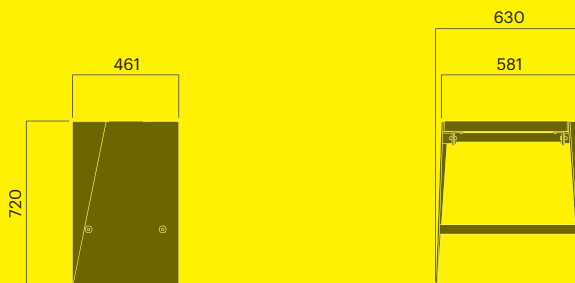

## Bloc barstol med rygg

		kg CO <sub>2</sub> e	MJ	kg
Art. 1523-900	15 800 NOK	234	3 478	85
Art. 1523-901	12 800 NOK	234	3 478	85

\* GWP & MJ proxy based on 1503-900

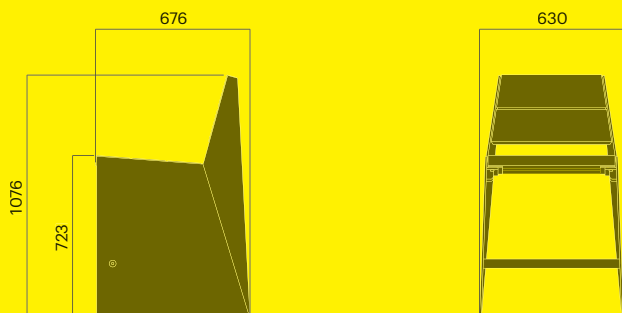

## Bloc krakk

		kg CO <sub>2</sub> e	MJ	kg
Art. 1506-900	10 800 NOK	145	2 304	60
Art. 1506-901	9 600 NOK	145	2 304	60

### Startmodul

Art. 1507-900	12 000 NOK	152	2 398	62
Art. 1507-901	10 500 NOK	152	2 398	62

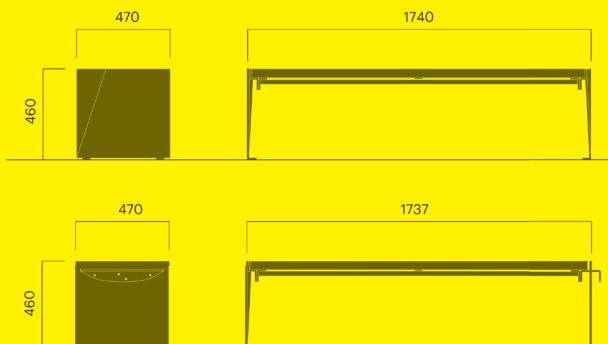

## Bloc krakk

Påbyggningsmodul		kg CO <sub>2</sub> e	MJ	kg
Art. 1508-900	<b>9 200 NOK</b>	99	1 665	46
Art. 1508-901	<b>8 100 NOK</b>	99	1 665	46
<b>Endemodul</b>				
Art. 1509-900	<b>8 700 NOK</b>	94	1 590	44
Art. 1509-901	<b>7 600 NOK</b>	94	1 590	44

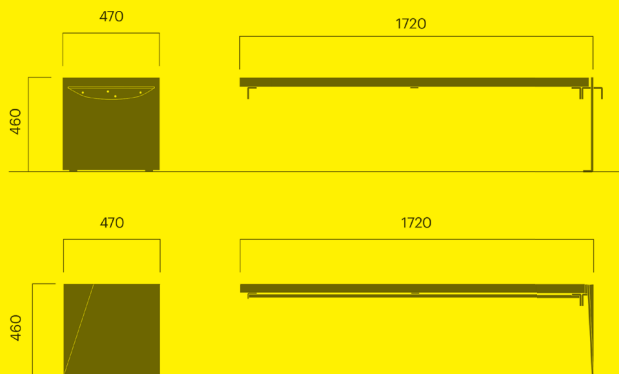

## Bloc benk

		kg CO <sub>2</sub> e	MJ	kg
Art. 1516-900	<b>14 900 NOK</b>	201	3 273	88
Art. 1516-901	<b>12 800 NOK</b>	201	3 273	88

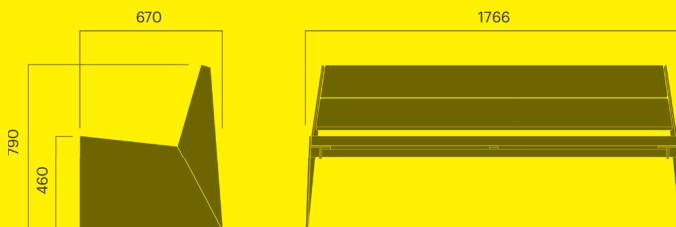

## Bloc benk startmodul

		kg CO <sub>2</sub> e	MJ	kg
Art. 1553-900	<b>17 000 NOK</b>	209	3 374	89
Art. 1553-901	<b>14 300 NOK</b>	209	3 374	89

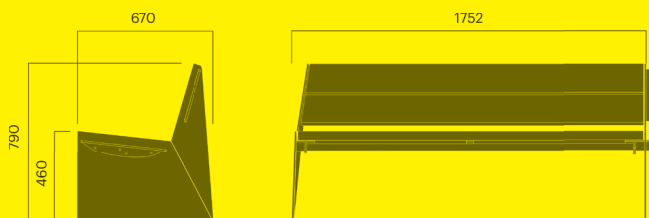



## Bloc benk påbygningsmodul

		kg CO <sub>2</sub> e	MJ	kg
Art. 1554-900	<b>13 300 NOK</b>	134	2 351	66
Art. 1554-901	<b>11 600 NOK</b>	134	2 351	66



## Bloc benk endemodul

		kg CO <sub>2</sub> e	MJ	kg
Art. 1555-900	<b>12 400 NOK</b>	127	2 230	63
Art. 1555-901	<b>10 600 NOK</b>	127	2 230	63

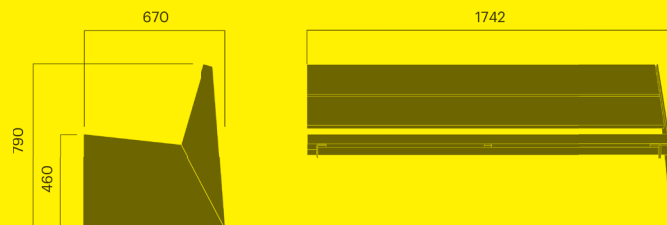

## Bloc benk

		kg CO <sub>2</sub> e	MJ	kg
Med armlene				
Art. 1517-900	<b>17 000 NOK</b>	221	3 546	94
Art. 1517-901	<b>13 700 NOK</b>	221	3 546	94

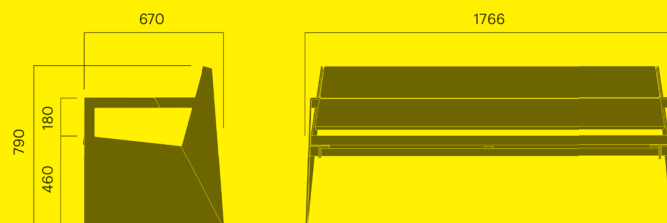

## Bloc benk startmodul

Med armlene		kg CO <sub>2</sub> e	MJ	kg
Art. 1556-900	<b>17 800 NOK</b>	218	3 505	92
Art. 1556-901	<b>14 700 NOK</b>	218	3 505	92
Med armlene for viderekopling				
Art. 1559-900	<b>18 100 NOK</b>	218	3 505	96
Art. 1559-901	<b>15 000 NOK</b>	218	3 505	96

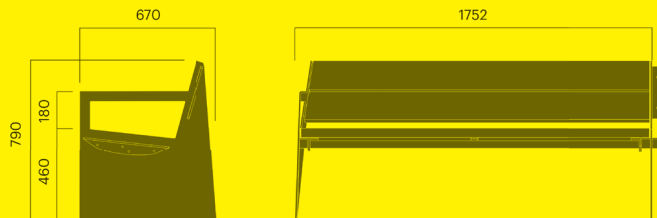

## Bloc benk påbygningsmodul

Med armlene		kg CO <sub>2</sub> e	MJ	kg
Art. 1557-900	<b>13 400 NOK</b>	144	2 478	68
Art. 1557-901	<b>12 100 NOK</b>	144	2 478	68

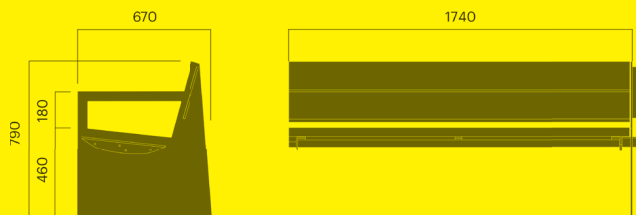

## Bloc benk endemodul

Med armlene		kg CO <sub>2</sub> e	MJ	kg
Art. 1558-900	<b>12 900 NOK</b>	136	2 361	66
Art. 1558-901	<b>10 900 NOK</b>	136	2 361	66

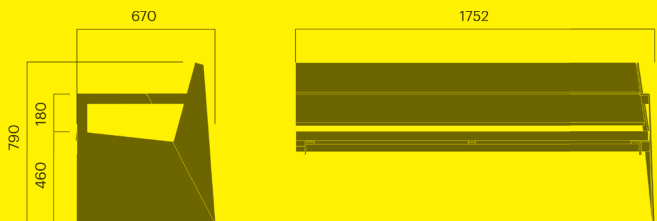

## Bloc benk dobbel rygg mot rygg

Komplett benk rygg mot rygg		kg CO <sub>2</sub> e	MJ	kg
Art. 1532-900	<b>37 100 NOK</b>	442	7 201	192
Art. 1532-901	<b>30 400 NOK</b>	442	7 201	192

### Startmodul rygg mot rygg

Art. 1574-900	<b>36 300 NOK</b>	456	7 381	196
Art. 1574-901	<b>31 700 NOK</b>	456	7 381	196

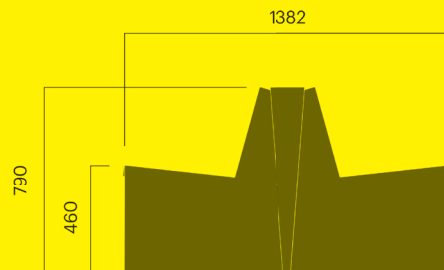

## Bloc benk dobbel rygg mot rygg med armlener

Komplett benk rygg mot rygg med armlener		kg CO <sub>2</sub> e	MJ	kg
Art. 1534-900	<b>37 900 NOK</b>	480	7 730	204
Art. 1534-901	<b>31 900 NOK</b>	480	7 730	204

### Startmodul rygg mot rygg med armlener for viderekobling

Art. 1571-900	<b>36 700 NOK</b>	476	7 655	202
Art. 1571-901	<b>32 500 NOK</b>	476	7 655	202

### Startmodul rygg mot rygg med armlener på startvangen

Art. 1570-900	<b>37 900 NOK</b>	476	7 655	208
Art. 1570-901	<b>32 400 NOK</b>	476	7 655	208

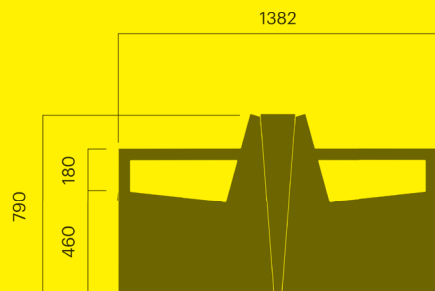

## Bloc benk rygg mot rygg påbyggingsmoduler

Uten armlener		kg CO <sub>2</sub> e	MJ	kg
Art. 1572-900	<b>24 100 NOK</b>	282	4 779	131
Art. 1572-901	<b>23 100 NOK</b>	282	4 779	131

### Med armlener

Art. 1533-900	<b>24 900 NOK</b>	300	5 032	137
Art. 1533-901	<b>22 700 NOK</b>	300	5 032	137



## Bloc bank rygg mot rygg endemoduler

Med armlener		kg CO <sub>2</sub> e	MJ	kg
Art. 1575-900	<b>28 200 NOK</b>	274	4 849	138
Art. 1575-901	<b>24 100 NOK</b>	274	4 849	138
Uten armlener		kg CO <sub>2</sub> e	MJ	kg
Art. 1573-900	<b>28 700 NOK</b>	385	5 832	144
Art. 1573-901	<b>24 800 NOK</b>	385	5 832	144



## Bloc solbank

Smal		kg CO <sub>2</sub> e	MJ	kg
Art. 1566-900	<b>23 900 NOK</b>	303	4 970	134
Art. 1566-901	<b>19 800 NOK</b>	303	4 970	134
Art. 1565-900	<b>22 900 NOK</b>	303	4 970	120
Art. 1565-901	<b>18 900 NOK</b>	303	4 970	120

Tilegg hjul 3700 NOK

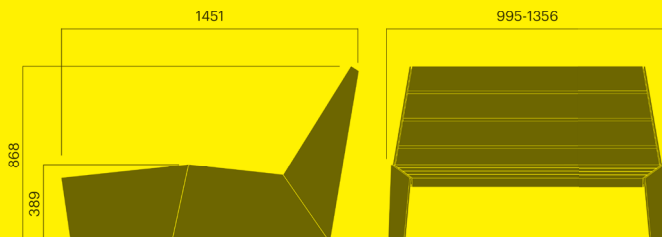

## Bloc solbank startmodul

		kg CO <sub>2</sub> e	MJ	kg
Art. 1567-900	<b>25 900 NOK</b>	316	5 173	139
Art. 1567-901	<b>21 100 NOK</b>	316	5 173	139
Overgangsmodul til kort sete				
Art. 1567-900K	<b>24 800 NOK</b>	312	5 115	139
Art. 1567-901K	<b>20 700 NOK</b>	312	5 115	139

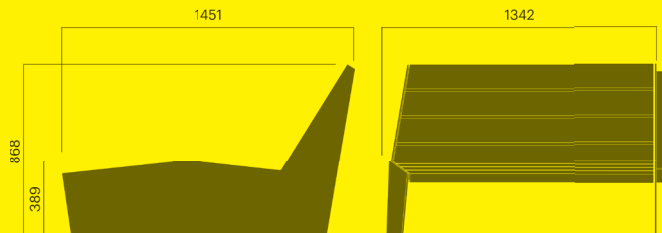

## Bloc solbenk påbygningsmodul

		kg CO <sub>2</sub> e	MJ	kg
Art. 1568-900	<b>19 900 NOK</b>	187	3 347	97
Art. 1568-901	<b>18 400 NOK</b>	187	3 347	97

### Overgangsmodul til kort sete

Art. 1568-900K	<b>19 400 NOK</b>	183	3 288	92
Art. 1568-901K	<b>18 000 NOK</b>	183	3 288	96

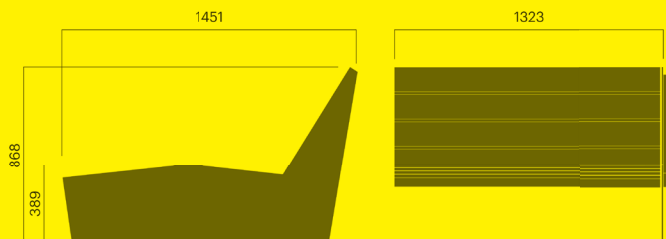

## Bloc solbenk endemodul

		kg CO <sub>2</sub> e	MJ	kg
Art. 1569-900	<b>17 800 NOK</b>	175	3 180	94
Art. 1569-901	<b>15 200 NOK</b>	175	3 180	94

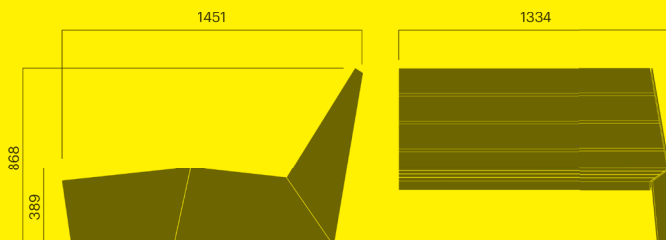

## Bloc solbenk ryggkobling

		kg CO <sub>2</sub> e	MJ	kg
Art. 1560-900	<b>9 500 NOK</b>	67	1 009	25
Art. 1560-901	<b>8 500 NOK</b>	67	1 009	25

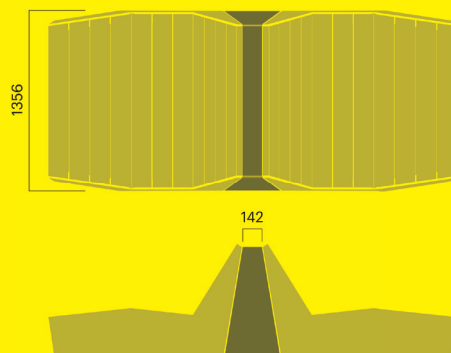

## Bloc solbenk ryggkobling

### Startmodul

		kg CO <sub>2</sub> e	MJ	kg
Art. 1561-900	<b>9 500 NOK</b>	127	1 849	20
Art. 1561-901	<b>8 500 NOK</b>	127	1 849	20

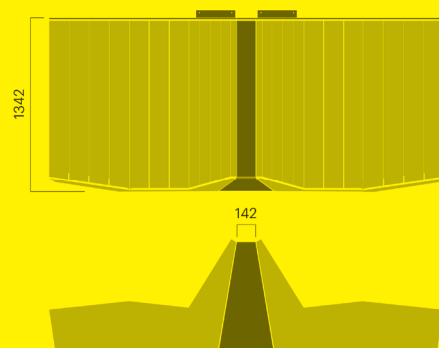

## Bloc solbenk ryggkobling

### Påbyggningsmodul

		kg CO <sub>2</sub> e	MJ	kg
Art. 1562-900	<b>6 200 NOK</b>	63	957	42
Art. 1562-901	<b>5 100 NOK</b>	63	957	42

### Endemodul

Art. 1563-900	<b>6 200 NOK</b>	67	1 009	24
Art. 1563-901	<b>5 100 NOK</b>	67	1 009	24

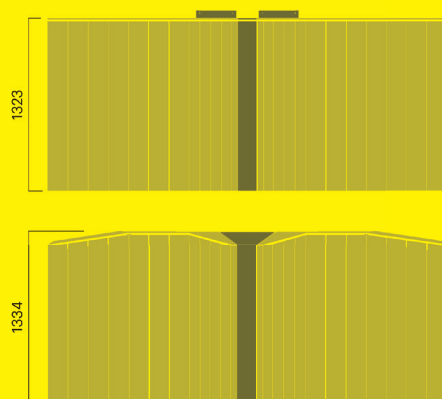

## Bloc kort solbenk

		kg CO <sub>2</sub> e	MJ	kg
Art. 1576-900	<b>16 900 NOK</b>	194	3 185	86
Art. 1576-901	<b>14 800 NOK</b>	194	3 185	86

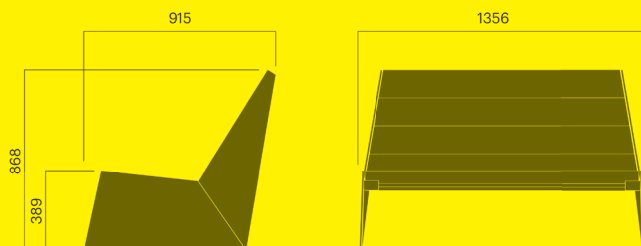

## Bloc kort solbenk startmodul

		kg CO <sub>2</sub> e	MJ	kg
Art. 1577-900	<b>18 000 NOK</b>	239	3 816	130
Art. 1577-901	<b>16 300 NOK</b>	239	3 816	130

### Overgangsmodul til langt sete

Art. 1577-900K	<b>21 300 NOK</b>	274	4 367	130
Art. 1577-901K	<b>19 000 NOK</b>	274	4 367	130

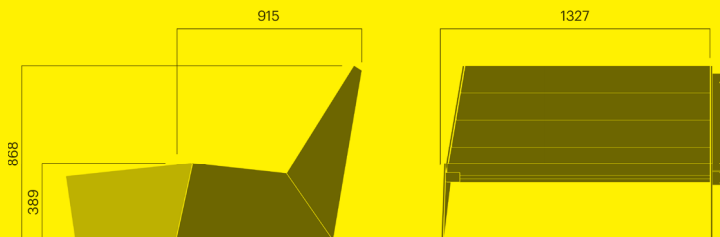

## Bloc kort solbenk påbygningsmodul

		kg CO <sub>2</sub> e	MJ	kg
Art. 1578-900	<b>13 300 NOK</b>	152	2 454	65
Art. 1578-901	<b>11 600 NOK</b>	152	2 454	65

### Overgangsmodul til langt sete

Art. 1578-900K	<b>15 400 NOK</b>	181	3 005	65
Art. 1578-901K	<b>13 400 NOK</b>	181	3 005	65

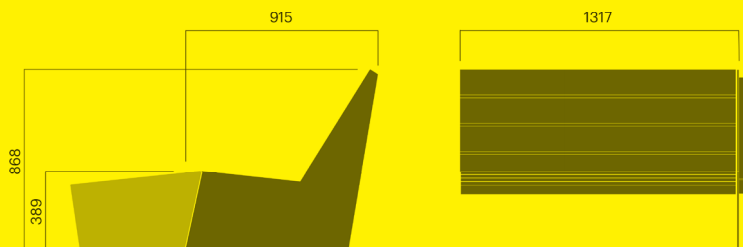

## Bloc kort solbenk endemodul

		kg CO <sub>2</sub> e	MJ	kg
Art. 1579-900	<b>12 600 NOK</b>	108	1 862	71
Art. 1579-901	<b>11 600 NOK</b>	108	1 862	71

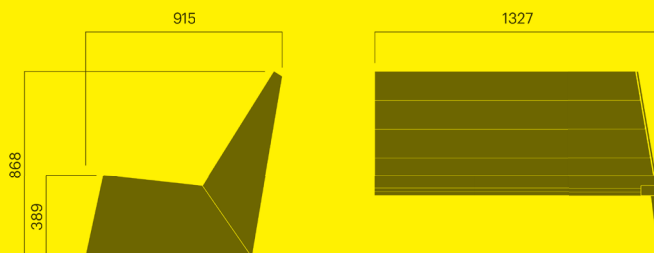

## Bloc lavt bord

		kg CO <sub>2</sub> e	MJ	kg
Art. 1530-900	<b>12 600 NOK</b>	155	2 372	60
Art. 1530-901	<b>11 700 NOK</b>	155	2 372	60

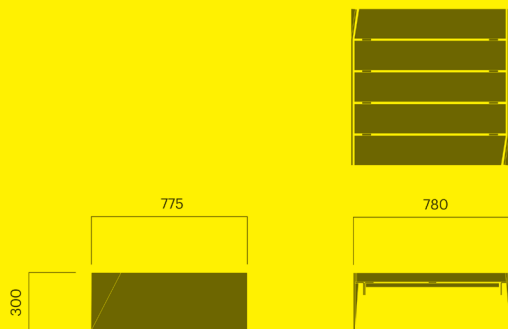

## Bloc bord

		kg CO <sub>2</sub> e	MJ	kg
Art. 1536-900	<b>17 000 NOK</b>	273	4 180	102
Art. 1536-901	<b>14 800 NOK</b>	273	4 180	102

### Startmodul

Art. 1537-900	<b>17 000 NOK</b>	273	4 180	105
Art. 1537-901	<b>14 600 NOK</b>	273	4 180	111

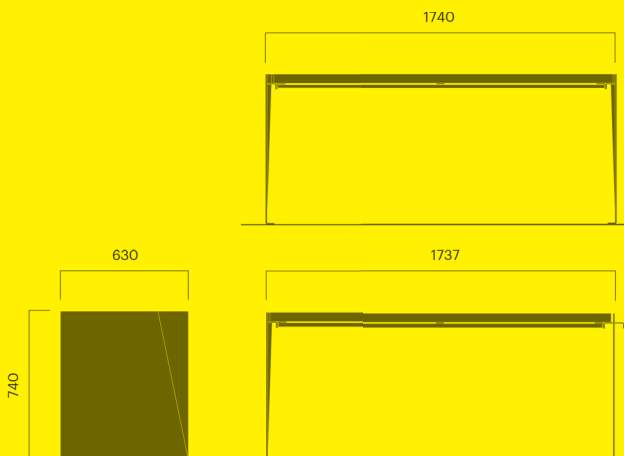

## Bloc bord påbygningsmodul

		kg CO <sub>2</sub> e	MJ	kg
Art. 1538-900	<b>12 200 NOK</b>	166	2 697	72
Art. 1538-901	<b>11 000 NOK</b>	166	2 697	72

### Bloc bord endemodul

Art. 1539-900	<b>12 200 NOK</b>	158	2 575	69
Art. 1539-901	<b>10 500 NOK</b>	158	2 575	69

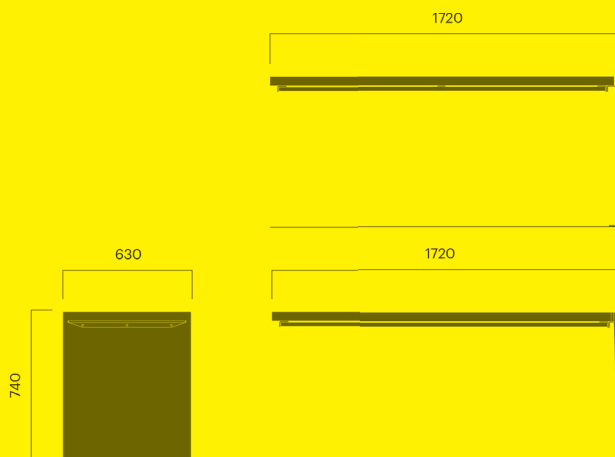



## Bloc barbord

		kg CO <sub>2</sub> e	MJ	kg
Art. 1531-900	19 800 NOK	359	5 500	134
Art. 1531-901	16 800 NOK	359	5 500	134

\* GWP & MJ proxy based on 1531-900

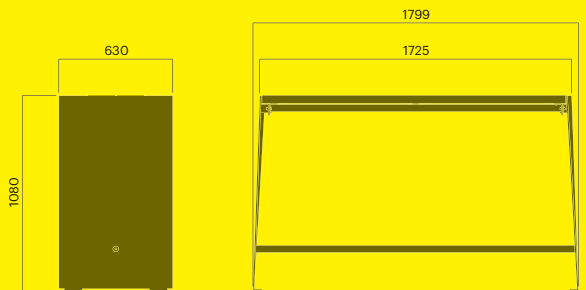

## Bloc avfallsbeholder

100 liter		kg CO <sub>2</sub> e	MJ	kg
Art. 1546-900	13 400 NOK	164	2 290	51
Art. 1546-901	11 200 NOK	164	2 290	51

For oppheng på vegg

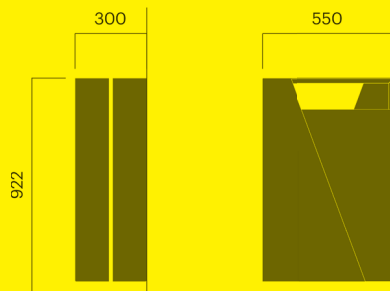

## Bloc avfallsbeholder

100 liter		kg CO <sub>2</sub> e	MJ	kg
Art. 1542-900	14 600 NOK	229	3 236	72
Art. 1542-901	12 600 NOK	229	3 236	72

Med askebeuger

Art. 1543-900	16 600 NOK	231	3 232	74
Art. 1543-901	14 400 NOK	231	3 232	74

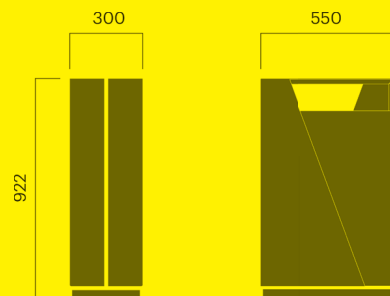

## Bloc avfallsbeholder

140 liter		kg CO <sub>2</sub> e	MJ	kg
Art. 1544-900	20 200 NOK	355	4 958	104
Art. 1544-901	18 000 NOK	355	4 958	104
<b>Med askebeuger</b>				
Art. 1545-900	23 000 NOK	329	4 596	105
Art. 1545-901	20 500 NOK	329	4 596	105

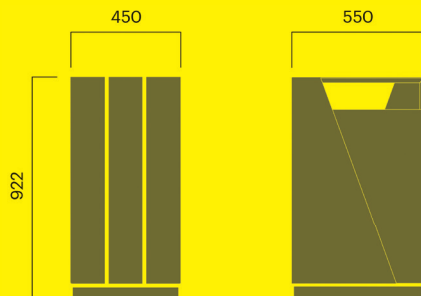

## Bloc kildesortering

2 x 100 liter		kg CO <sub>2</sub> e	MJ	kg
Art. 1548-900	26 800 NOK	331	4 672	103
Art. 1548-901	22 800 NOK	331	4 672	103
<b>3 x 100 liter</b>				
Art. 1549-900	39 800 NOK	497	7 019	154
Art. 1549-901	33 800 NOK	497	7 019	154
<b>2 x 100 liter, inkludert liner</b>				
Art. 1548-900L	33 600 NOK	353	4 982	109
Art. 1548-901L	29 600 NOK	353	4 982	109
<b>3 x 100 liter, inkludert liner</b>				
Art. 1549-900L	49 800 NOK	529	7 475	164
Art. 1549-901L	43 800 NOK	529	7 475	164

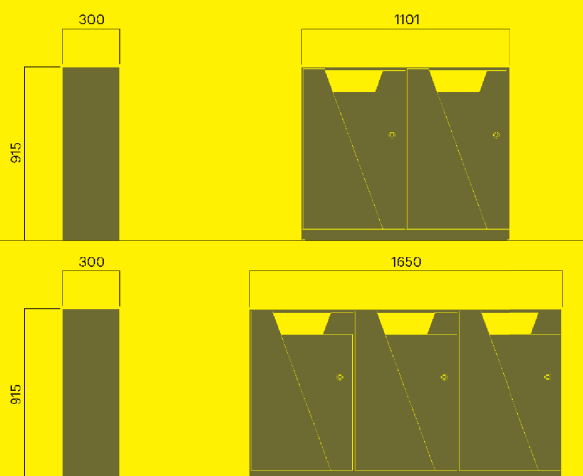

\* GWP & MJ proxy based on 1542-900

## Bloc liner

70 liter		kg CO <sub>2</sub> e	MJ	kg
Art. 15991-901	2 900 NOK	22	308	7
Art. 15992-901	3 400 NOK	18	260	6

\* GWP & MJ proxy based on 1542-900

## Bloc plantekasse

45 liter		kg CO <sub>2</sub> e	MJ	kg
Art. 1581-900	10 200 NOK	187	2 601	59
Art. 1581-901	8 800 NOK	187	2 601	59
200 liter				
Art. 1582-900	18 600 NOK	408	5 677	130
Art. 1582-901	15 800 NOK	408	5 677	130

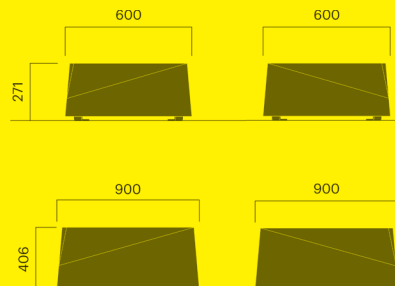

## Bloc plantekasse

520 liter		kg CO <sub>2</sub> e	MJ	kg
Art. 1583-900	29 300 NOK	715	9 952	227
Art. 1583-901	24 800 NOK	715	9 952	227
1250 liter				
Art. 1584-900	41 200 NOK	1193	16 618	379
Art. 1584-901	34 800 NOK	1193	16 618	375

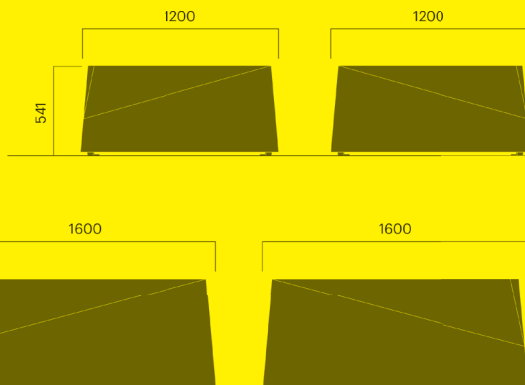

## Boboli



### Boboli planteurne

150 liter		kg CO <sub>2</sub> e	MJ	kg
Art. bob 065-070	8 800 NOK	-	-	45
Art. bob 065-070RAL	8 800 NOK	-	-	45

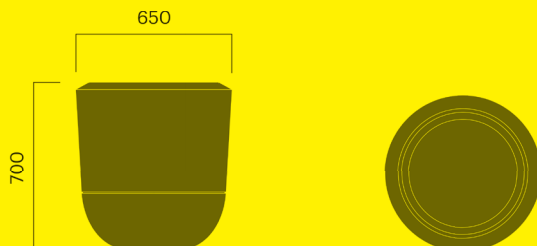

## Boboli planteurne

		kg CO <sub>2</sub> e	MJ	kg
170 liter				
Art. bob 090-038	9 200 NOK	-	-	35

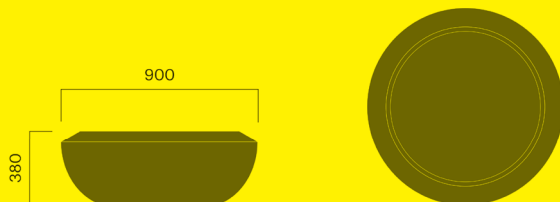

## Boboli planteurne

		kg CO <sub>2</sub> e	MJ	kg
380 liter				
Art. bob 090-070	13 500 NOK	-	-	65

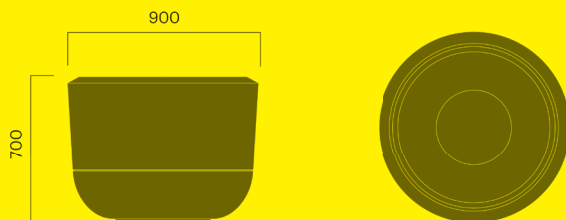

## Boboli planteurne

		kg CO <sub>2</sub> e	MJ	kg
500 liter				
Art. bob 090-090	14 600 NOK	-	-	80
Art. bob 090-090RAL	14 600 NOK	-	-	80

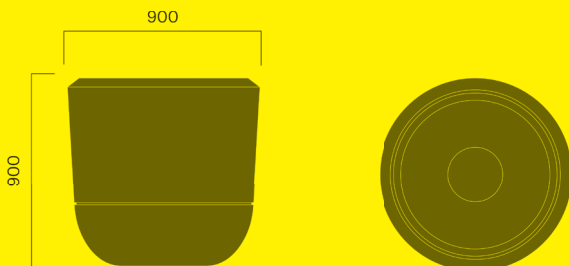

## Boboli planteurne

560 liter	kg CO <sub>2</sub> e	MJ	kg	
Art. bob 120-070	17 700 NOK	-	-	80

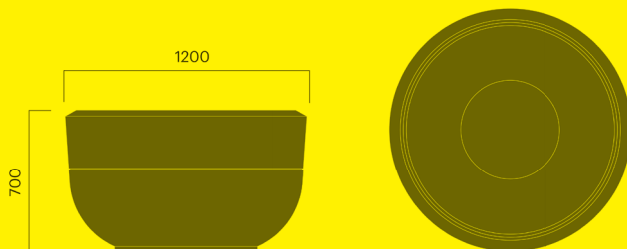

## Boboli planteurne

760 liter	kg CO <sub>2</sub> e	MJ	kg	
Art. bob 180-038	18 000 NOK	-	-	70

Vanningsystem på forespørsel. Kan leveres med dreneringshull uten ekstra kostnad.

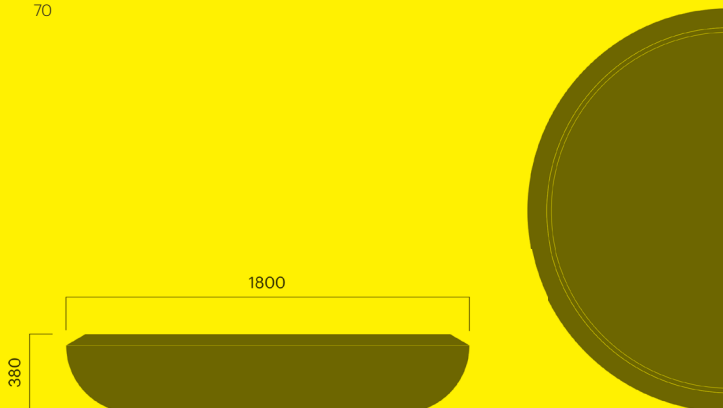

## Boboli planteurne

760 liter	kg CO <sub>2</sub> e	MJ	kg	
Art. bob 130-038	12 200 NOK	-	-	350

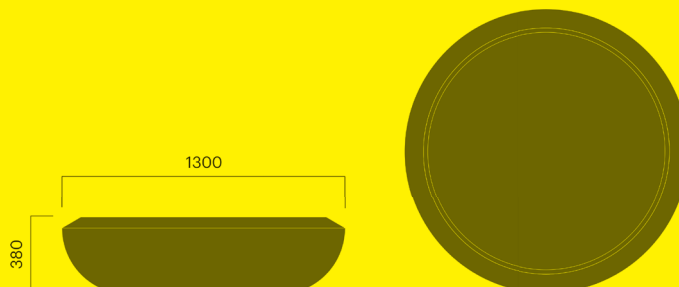



## Bøy sykkelstativ

For 2 sykler		kg CO <sub>2</sub> e	MJ	kg
Art. 388-900	3 100 NOK	37	512	12
Art. 388-901	2 500 NOK	37	512	12

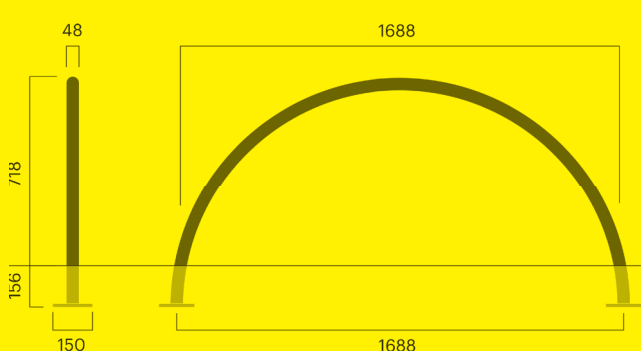

## Briskeby



### Briskeby krakk

		kg CO <sub>2</sub> e	MJ	kg
Art. 6006-900	14 500 NOK	139	2 252	61
Art. 6006-901	12 500 NOK	139	2 252	61
Art. 6006-960	29 000 NOK	139	2 252	58

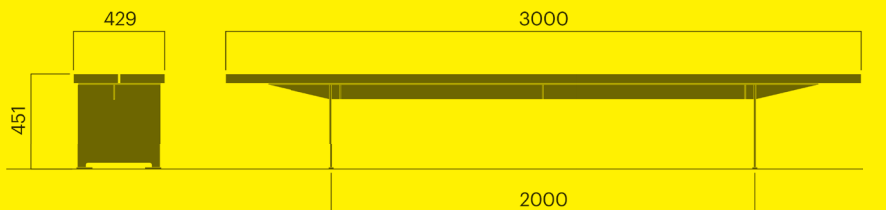

## Briskeby krakk

Med armlene		kg CO <sub>2</sub> e	MJ	kg
Art. 6007-900	<b>16 800 NOK</b>	139	2 252	64
Art. 6007-901	<b>14 800 NOK</b>	150	2 404	64
Art. 6007-960	<b>32 800 NOK</b>	150	2 404	64

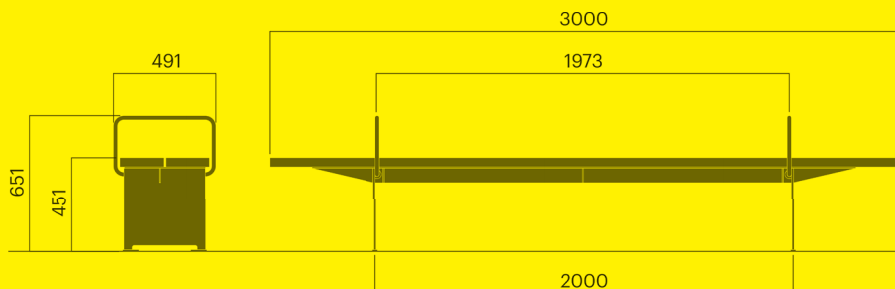

## Briskeby kort bank

		kg CO <sub>2</sub> e	MJ	kg
Art. 6013-900	<b>16 500 NOK</b>	150	2 460	67
Art. 6013-901	<b>14 500 NOK</b>	150	2 460	67
Art. 6013-960	<b>33 000 NOK</b>	150	2 460	64

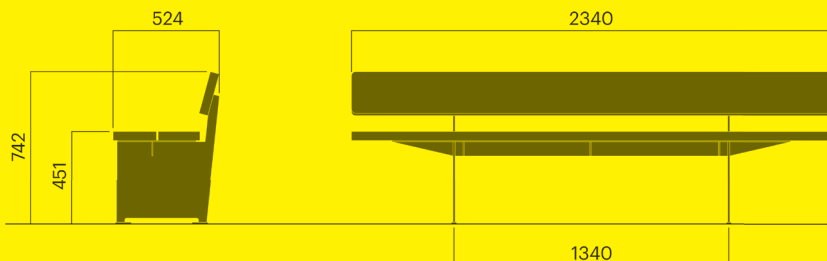

## Briskeby bank

		kg CO <sub>2</sub> e	MJ	kg
Art. 6016-900	<b>17 500 NOK</b>	163	2 737	78
Art. 6016-901	<b>15 200 NOK</b>	163	2 737	78
Art. 6016-960	<b>39 800 NOK</b>	163	2 737	78

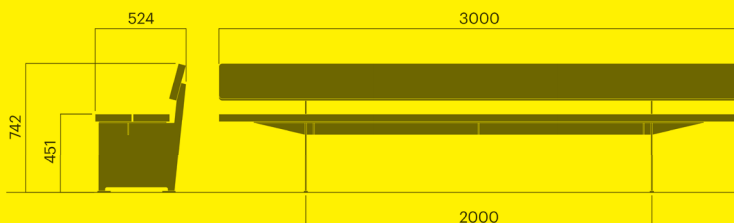

## Briskeby benk

Med armlene		kg CO <sub>2</sub> e	MJ	kg
Art. 6017-900	19 800 NOK	189	3 123	83
Art. 6017-901	17 800 NOK	189	3 123	83
Art. 6017-960	44 800 NOK	189	3 123	73

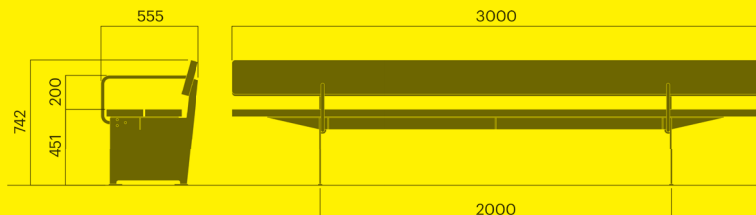

## Buzz



### Buzz benkebord

Bord og seter i høytrykkslaminat (HPL), med mulighet for grafisk motiv (tillegg i pris)

		kg CO <sub>2</sub> e	MJ	kg
Art. 3316-900	28 700 NOK	149	2 337	70
Art. 3316-901	24 400 NOK	149	2 337	70

### Bord i stål og seter i tre

Art. 3317-900	25 600 NOK	244	3 489	81
Art. 3317-901	19 800 NOK	244	3 489	81

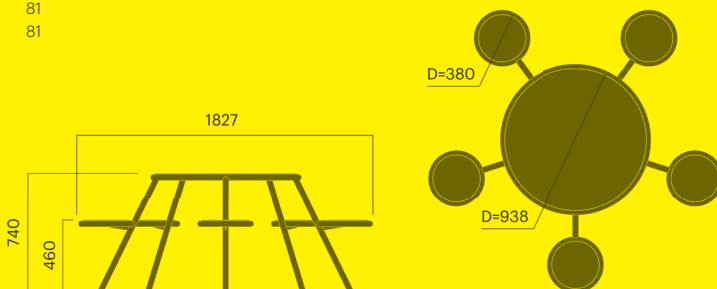

### Buzz benkebord tilpasset rullestol

Bord og seter i høytrykkslaminat (HPL), med mulighet for grafisk motiv (tillegg i pris)

		kg CO <sub>2</sub> e	MJ	kg
Art. 3316-900H	25 600 NOK	144	2 247	60
Art. 3316-901H	21 200 NOK	144	2 247	60

### Bord i stål og seter i tre

Art. 3317-900H	24 100 NOK	223	3 171	73
Art. 3317-901H	18 100 NOK	223	3 171	73

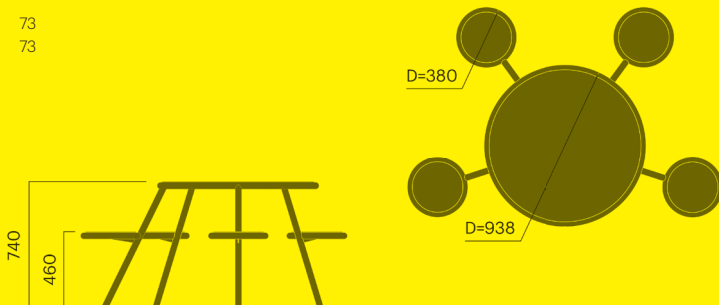





## City avfallsbeholder

For oppheng på stolpe eller vegg

50 liter, med flat topp		kg CO <sub>2</sub> e	MJ	kg
Art. 241-900	8 500 NOK	91	1 274	25
Art. 241-901	7 200 NOK	91	1 274	24

50 liter, Med buet topp		kg CO <sub>2</sub> e	MJ	kg
Art. 251-900	10 000 NOK	101	1 409	30
Art. 251-901	8 700 NOK	101	1 409	31

50 liter, Med askebeuger		kg CO <sub>2</sub> e	MJ	kg
Art. 259-900	12 000 NOK	102	1 428	29
Art. 259-901	10 500 NOK	102	1 428	38

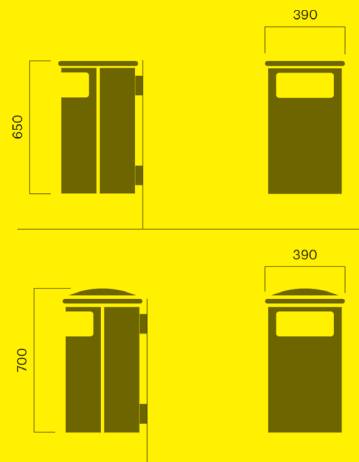

## City avfallsbeholder delt innkast

50 liter

Med flat topp		kg CO <sub>2</sub> e	MJ	kg
Art. 244-900	8 900 NOK	98	1 366	25
Art. 244-901	5 900 NOK	98	1 366	25

Med buet topp		kg CO <sub>2</sub> e	MJ	kg
Art. 254-900	10 200 NOK	99	1 387	28
Art. 254-901	8 900 NOK	99	1 387	28

Med askebeuger		kg CO <sub>2</sub> e	MJ	kg
Art. 255-900	12 000 NOK	98	1 366	29
Art. 255-901	8 700 NOK	98	1 366	29

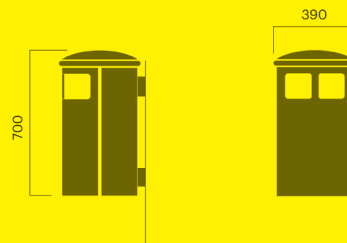

## City monteringsstolpe

Forankring A eller C		kg CO <sub>2</sub> e	MJ	kg
Art. 292-900A	2 200 NOK	25	352	9
Art. 292-901A	1 900 NOK	25	352	8
Art. 292-900C	1 900 NOK	29	399	10
Art. 292-901C	1 600 NOK	29	399	8

Stolpe D = 76/60		kg CO <sub>2</sub> e	MJ	kg
Art. 293-900	2 200 NOK	25	344	11
Art. 293-901	1 900 NOK	25	344	11

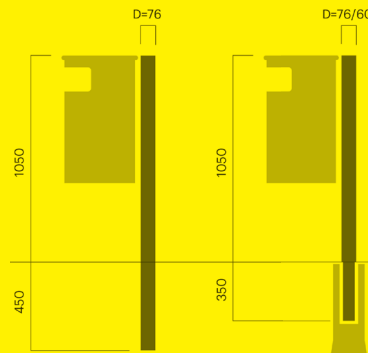

## City festklammer

Til 4" stolpe D 101		kg CO <sub>2</sub> e	MJ	kg
Art. 290-900	1 200 NOK	7	94	3
Art. 290-901	900 NOK	7	94	3
<b>Til 5" stolpe D 127</b>				
Art. 291-900	1 200 NOK	7	99	2
Art. 291-901	900 NOK	7	99	2

Sett



## City avfallsbeholder

70 liter

Med flat topp		kg CO <sub>2</sub> e	MJ	kg
Art. 242-900	9 800 NOK	106	1 474	32
Art. 242-901	8 400 NOK	106	1 474	32
<b>Med buet topp</b>				
Art. 252-900	13 600 NOK	115	1 605	35
Art. 252-901	12 200 NOK	115	1 605	35
<b>Med askebegeg</b>				
Art. 243-900	11 600 NOK	119	1 658	36
Art. 243-901	10 200 NOK	119	1 658	36

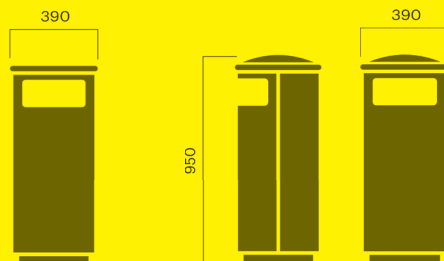

## City avfallsbeholder

150 liter

Med flat topp		kg CO <sub>2</sub> e	MJ	kg
Art. 247-900	11 400 NOK	139	1 931	49
Art. 247-901	9 900 NOK	139	1 931	49
<b>Med buet topp</b>				
Art. 257-900	13 400 NOK	132	1 920	53
Art. 257-901	11 900 NOK	132	1 920	54
<b>Med askebegeg</b>				
Art. 261-900	15 400 NOK	132	1 920	54
Art. 261-901	13 900 NOK	132	1 920	59

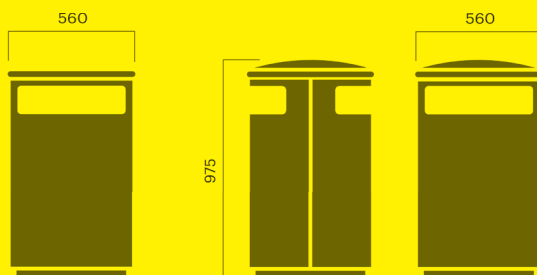

## City avfallsbeholder delt innkast

150 liter

		kg CO <sub>2</sub> e	MJ	kg
<b>Med buet topp</b>				
Art. 277-900	13 400 NOK	159	2 214	54
Art. 277-901	11 900 NOK	159	2 214	53
<b>Med askebegeg</b>				
Art. 278-900	15 800 NOK	164	2 290	55
Art. 278-901	12 500 NOK	164	2 290	53
<b>Med pant</b>				
Art. 279-900	12 200 NOK	178	2 477	58
Art. 279-901	10 700 NOK	178	2 477	53
<b>Med askebegeg og pant</b>				
Art. 280-900	15 800 NOK	183	2 552	59
Art. 280-901	14 300 NOK	183	2 552	59

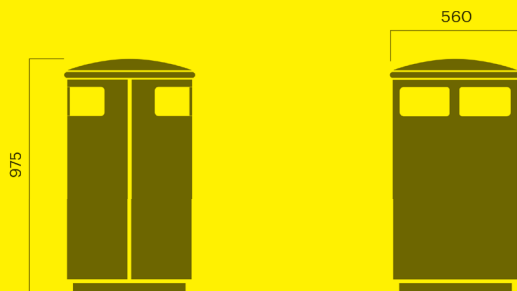

## City avfallsbeholder

180 liter

		kg CO <sub>2</sub> e	MJ	kg
<b>Med flat topp</b>				
Art. 248-900	11 800 NOK	157	2 184	55
Art. 248-901	10 300 NOK	157	2 184	53
<b>Med buet topp</b>				
Art. 258-900	13 800 NOK	176	2 453	61
Art. 258-901	12 200 NOK	176	2 453	61
<b>Med askebegeg</b>				
Art. 262-900	15 800 NOK	181	2 521	61
Art. 262-901	14 300 NOK	181	2 521	62

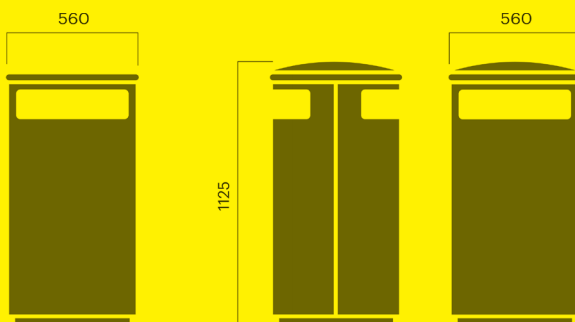

## City avfallsbeholder delt innkast

180 liter

		kg CO <sub>2</sub> e	MJ	kg
<b>Med flat topp</b>				
Art. 276-900	12 200 NOK	177	2 472	55
Art. 276-901	7 900 NOK	177	2 472	55
<b>Med buet topp</b>				
Art. 275-900	14 200 NOK	177	2 472	61
Art. 275-901	9 800 NOK	177	2 472	61
<b>Med askebegeg</b>				
Art. 274-900	16 200 NOK	182	2 535	61
Art. 274-901	14 700 NOK	182	2 535	55

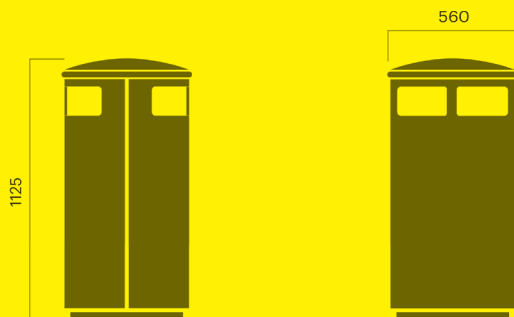

## City pant

180 liter

		kg CO <sub>2</sub> e	MJ	kg
<b>Med flat topp</b>				
Art. 270-900	16 400 NOK	194	2 704	57
Art. 270-901	14 500 NOK	194	2 704	57
<b>Med buet topp</b>				
Art. 272-900	17 800 NOK	194	2 704	63
Art. 272-901	15 200 NOK	194	2 704	63
<b>Med askebeger</b>				
Art. 271-900	19 600 NOK	194	2 704	65
Art. 271-901	18 200 NOK	194	2 704	65

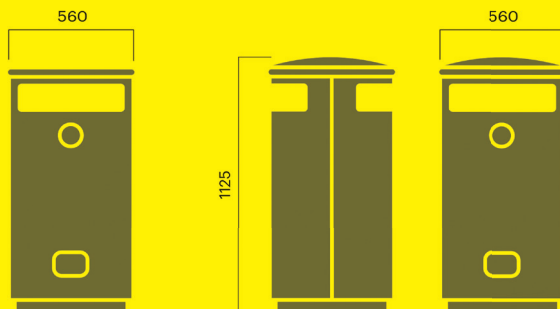

## City askebeger

		kg CO <sub>2</sub> e	MJ	kg
<b>For oppheng på vegg</b>				
Art. 265-900	3 500 NOK	18	253	5
Art. 265-901	3 300 NOK	18	253	5
<b>For oppheng på stolpe</b>				
Art. 266-900	3 600 NOK	20	286	6
Art. 266-901	3 500 NOK	20	286	6

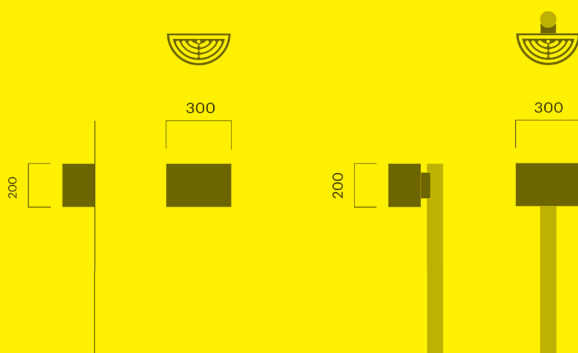

## City askebeger

Med buet topp og oppsamler 10 liter

		kg CO <sub>2</sub> e	MJ	kg
<b>H: 630</b>				
Art. 263-900	8 800 NOK	121	1 346	28
Art. 263-901	7 800 NOK	121	1 346	37
<b>H: 930</b>				
Art. 264-900	9 800 NOK	152	1 766	45
Art. 264-901	8 800 NOK	152	1 766	45

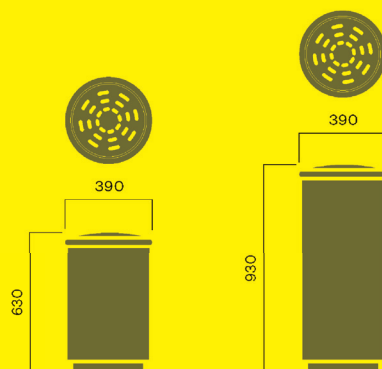

## City askebeger

Med flat topp 60 liter		kg CO <sub>2</sub> e	MJ	kg
Art. 267-900	9 400 NOK	82	1 190	32
Art. 267-901	8 500 NOK	82	1 190	32
Med flat topp 120 liter		kg CO <sub>2</sub> e	MJ	kg
Art. 268-900	10 700 NOK	109	1 601	28
Art. 268-901	9 800 NOK	109	1 601	35

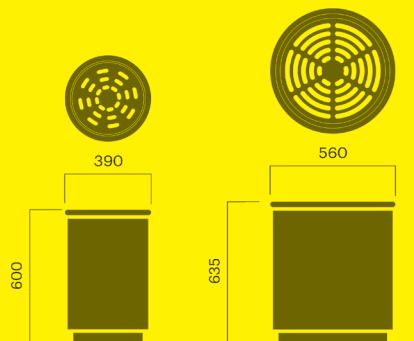

## City sykkelpullert

Komplett med fundament		kg CO <sub>2</sub> e	MJ	kg
For 2 sykklr	4 800 NOK	82	1 270	20
Art. 286-800				

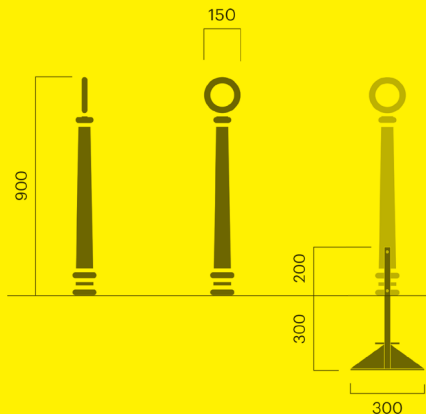

## Coast



### Coast benk av resirkulert eierløs havplast

Leiemodell på forespørsel		kg CO <sub>2</sub> e	MJ	kg
Art. 5506-530		-	-	-
Art. 5506-530		-	-	-
Versjon med tre		kg CO <sub>2</sub> e	MJ	kg
Art. 5506-900	21 200 NOK	193	2 973	75
Art. 5506-901	18 700 NOK	193	2 973	75

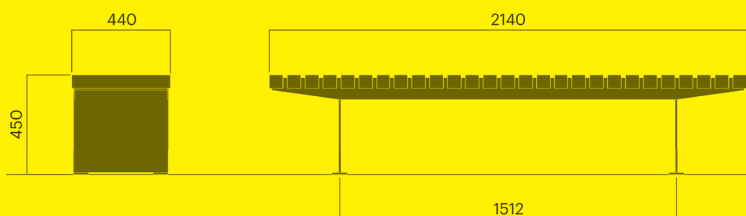

# Code



## Code Square modulbenk

Komplett grunnmodul		kg CO <sub>2</sub> e	MJ	kg
Art. 2616-900	12 900 NOK	137	2 226	60
Art. 2616-901	11 400 NOK	137	2 226	59
<b>Grunnmodul, uten tre</b>				
Art. 2617-900	6 600 NOK	100	1 393	32
Art. 2617-901	5 400 NOK	100	1 393	32
<b>Tresete</b>				
Art. 2620-900	4 900 NOK	20	492	17
Art. 2620-901	4 700 NOK	20	492	17
<b>Trefront</b>				
Art. 2624-900	3 300 NOK	17	349	6
Art. 2624-901	3 100 NOK	17	349	6
<b>Armlene</b>				
Art. 2628-900	4 600 NOK	42	586	13
Art. 2628-901	4 200 NOK	42	586	13

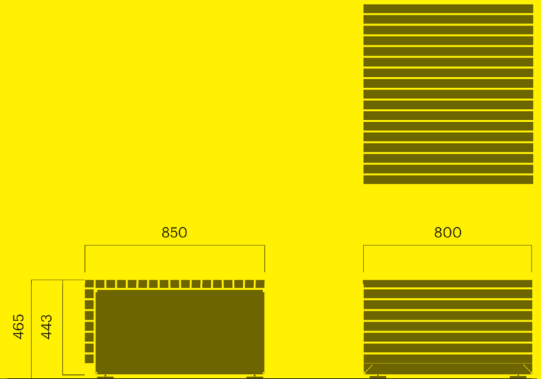

## Code Square plantekasse

250 liter		kg CO <sub>2</sub> e	MJ	kg
Art. 2640-900	12 300 NOK	182	2 530	68
Art. 2640-901	10 600 NOK	182	2 530	58
<b>500 liter</b>				
Art. 2646-900	15 800 NOK	285	3 975	102
Art. 2646-901	13 800 NOK	285	3 975	92

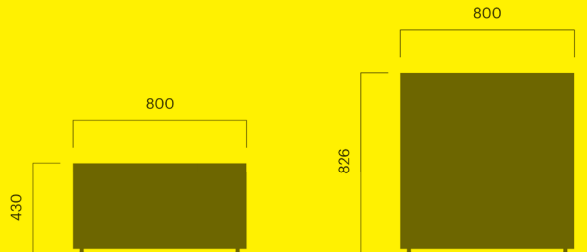

# Corner



## Corner benkeplate for murkant

		kg CO <sub>2</sub> e	MJ	kg
Art. 4103-900MK	12 700 NOK	79	1 384	39
Art. 4103-901MK	11 700 NOK	79	1 384	39

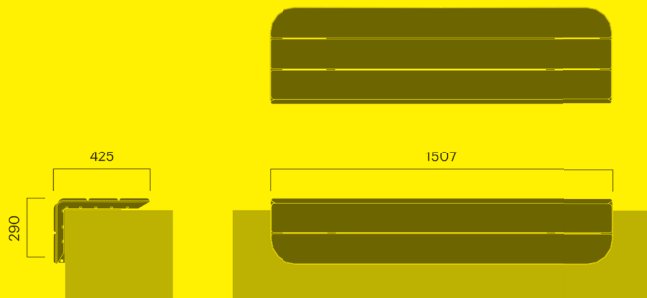

## Corner 1-seter for murkant

		kg CO <sub>2</sub> e	MJ	kg
Art. 4104-900MK	10 500 NOK	37	585	15
Art. 4104-901MK	9 500 NOK	37	585	15



## Cover



### Cover tak

Med ståltak		kg CO <sub>2</sub> e	MJ	kg
Art. 4701-900A	120 000 NOK	1945	27 166	618
Art. 4701-901A	105 000 NOK	1945	27 166	618
Med glasstak		kg CO <sub>2</sub> e	MJ	kg
Art. 4702-900A	130 000 NOK	1446	21 065	584
Art. 4702-901A	115 000 NOK	1446	21 065	584
Med sedumtak		kg CO <sub>2</sub> e	MJ	kg
Art. 4703-900A	135 000 NOK	1880	29 113	628
Art. 4703-901A	120 000 NOK	1880	29 113	628

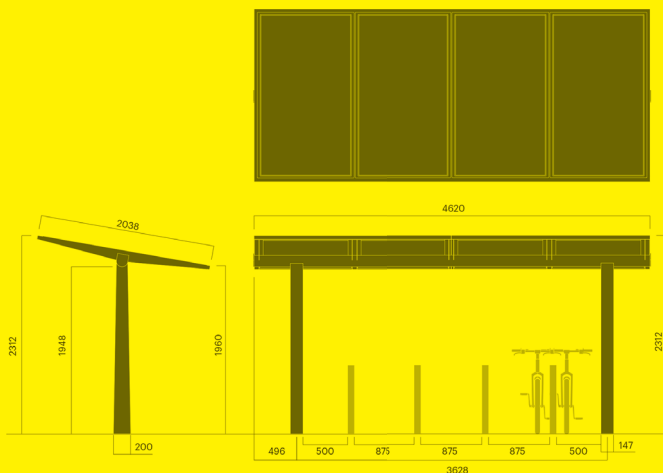

# Cycle



## Cycle sykkelstativ for 2 sykler

Forankring fotplate		kg CO <sub>2</sub> e	MJ	kg
Art. 4886-900A	8 000 NOK	52	718	16
Art. 4886-901A	8 000 NOK	52	718	16
Forankring nedstep		kg CO <sub>2</sub> e	MJ	kg
Art. 4886-900C	8 000 NOK	47	657	15
Art. 4886-901C	8 000 NOK	47	657	16

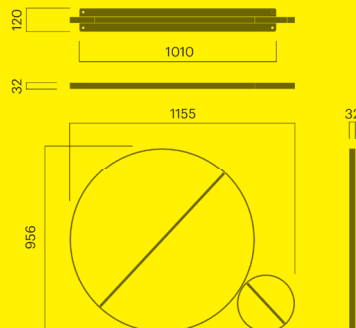

# Dialog



## Dialog benk

Kebony Clear		kg CO <sub>2</sub> e	MJ	kg
Art. 1406-932	31 900 NOK	29	884	35
Eik		kg CO <sub>2</sub> e	MJ	kg
Art. 1406-942	31 900 NOK	21	1 115	35

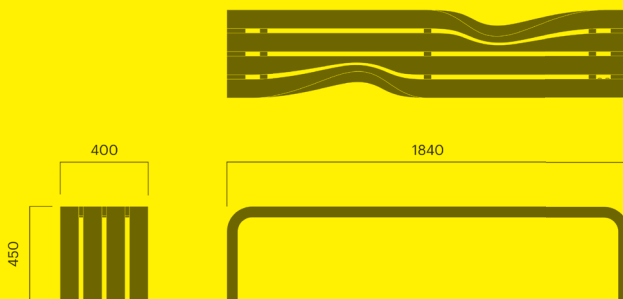



## Dialog avfallsbeholder

100 liter		kg CO <sub>2</sub> e	MJ	kg
Art. 1442-900	<b>14 800 NOK</b>	178	2 444	84
Art. 1442-901	<b>13 100 NOK</b>	178	2 444	84

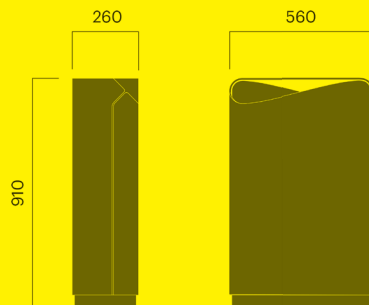

## Dialog kildesortering

3 x 55 liter		kg CO <sub>2</sub> e	MJ	kg
Art. 1448-900	<b>24 100 NOK</b>	282	3 932	89
Art. 1448-901	<b>21 900 NOK</b>	282	3 932	89

3 x 90 liter		kg CO <sub>2</sub> e	MJ	kg
Art. 1444-900	<b>24 100 NOK</b>	113	1 579	105
Art. 1444-901	<b>21 900 NOK</b>	113	1 579	105

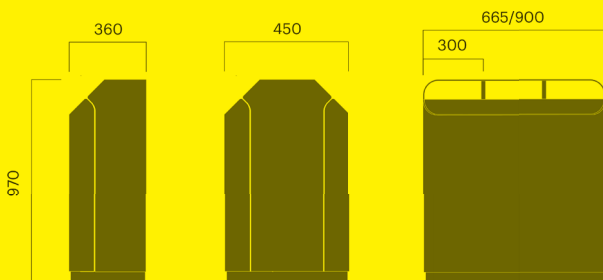

## Edo



### Edo krakk med marmorbord

Kebony, eik og ask		kg CO <sub>2</sub> e	MJ	kg
Art. 4308-930	<b>26 500 NOK</b>	55	1 383	30
Art. 4308-940	<b>26 500 NOK</b>	18	1 076	30
Art. 4308-950	<b>26 500 NOK</b>	18	1 076	30

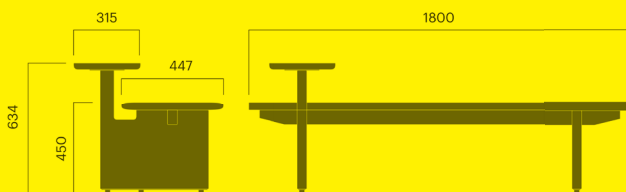

## Edo benk av heltre

Kebony, eik og ask		kg CO <sub>2</sub> e	MJ	kg
Art. 4316-930	31 900 NOK	57	1 427	40
Art. 4316-940	31 900 NOK	14	1 079	40
Art. 4316-950	31 900 NOK	14	1 079	40

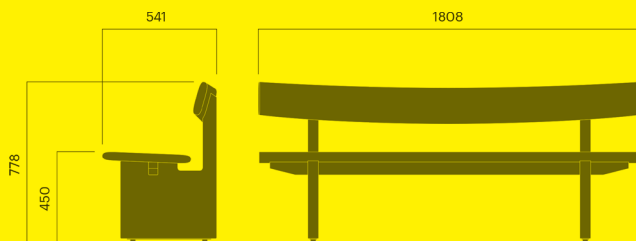

## Edo benk med stålvinger

		kg CO <sub>2</sub> e	MJ	kg
Art. 4315-930	25 800 NOK	155	2 834	69
Art. 4315-931	24 400 NOK	155	2 834	69

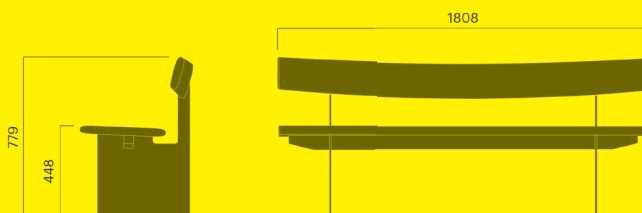

## Folk



### Folk krakk med armlene

		kg CO <sub>2</sub> e	MJ	kg
<b>Forankring nedstøp</b>				
Art. 4904-904C	10 200 NOK	50	983	25
<b>Forankring fotplate</b>				
Art. 4904-904A	11 600 NOK	61	1 168	27
<b>Frittstående</b>				
Art. 4904-904	12 600 NOK	41	839	23

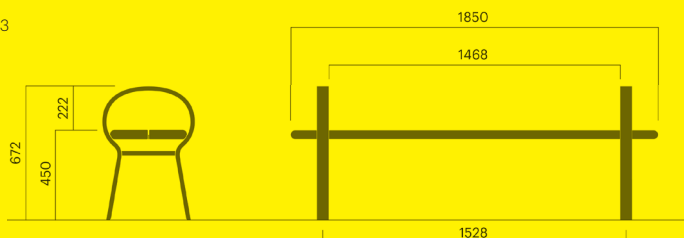

## Folk benk med armene

		kg CO <sub>2</sub> e	MJ	kg
<b>Forankring nedstøp</b>				
Art. 4914-904C	12 300 NOK	67	1 347	33
<b>Forankring fotplate</b>				
Art. 4914-904A	14 900 NOK	77	1 521	38
<b>Frittstående</b>				
Art. 4914-904	13 800 NOK	52	1 095	30

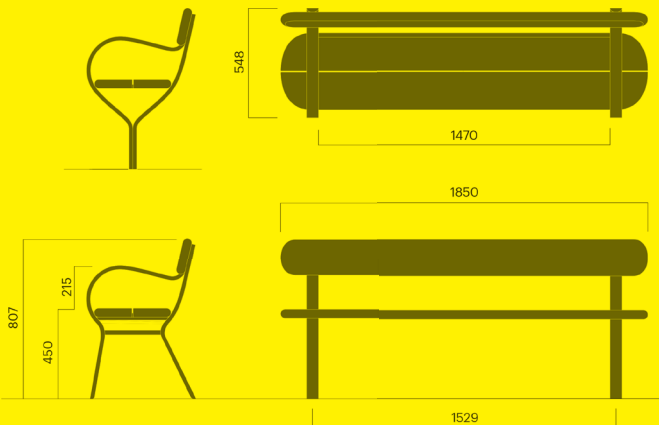

## Folk bord

		kg CO <sub>2</sub> e	MJ	kg
<b>Forankring nedstøp</b>				
Art. 4933-904C	12 000 NOK	96	1 908	39
<b>Forankring fotplate</b>				
Art. 4933-904A	13 800 NOK	108	2 104	39
<b>Frittstående</b>				
Art. 4933-904	13 800 NOK	54	1 201	35

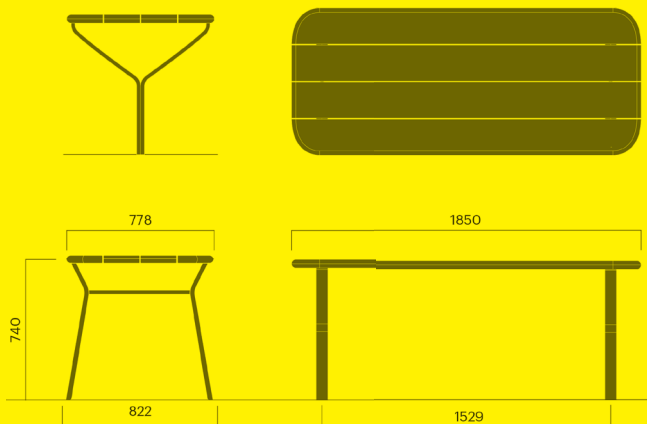

## Folk avfallsbeholder

		kg CO <sub>2</sub> e	MJ	kg
<b>50 liter</b>				
<b>Flat topp, forankring nedstøp</b>				
Art. 4942-904C	12 600 NOK	134	1 944	30
<b>Flat topp, forankring fotplate</b>				
Art. 4942-904A	13 700 NOK	134	1 944	30
<b>Skrå topp, forankring nedstøp</b>				
Art. 4943-904C	12 800 NOK	106	1 568	29
<b>Skrå topp, forankring fotplate</b>				
Art. 4943-904A	13 700 NOK	106	1 568	29

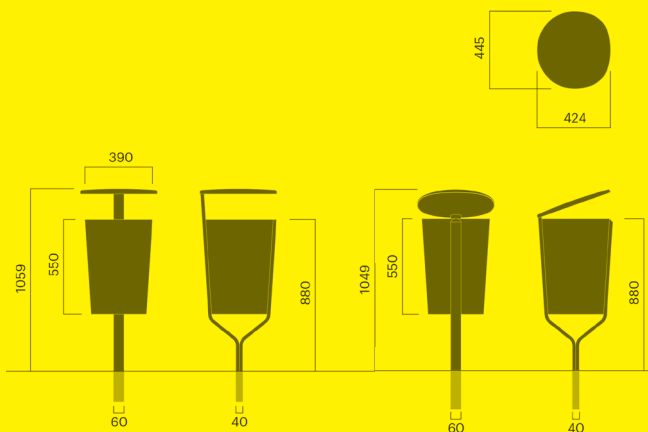

## Folk avfallsbeholder

Folk avfallsbeholder		kg CO <sub>2</sub> e	MJ	kg
Art. 4944-904	<b>17 000 NOK</b>	212	3 039	67

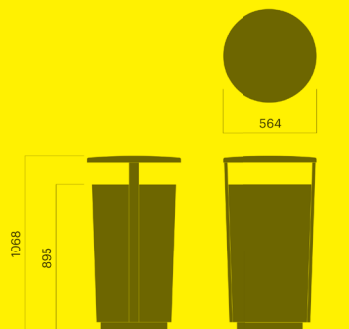

## Folk sykkelstativ

Liten, forankring nedstøp		kg CO <sub>2</sub> e	MJ	kg
Art. 4987-904C	<b>2 800 NOK</b>	22	371	7

Liten, forankring fotplate		kg CO <sub>2</sub> e	MJ	kg
Art. 4987-904A	<b>3 600 NOK</b>	28	469	8

Stor, forankring fotplate		kg CO <sub>2</sub> e	MJ	kg
Art. 4986-904A	<b>3 700 NOK</b>	28	464	9

Stor, forankring nedstøp		kg CO <sub>2</sub> e	MJ	kg
Art. 4986-904C	<b>2 900 NOK</b>	22	371	8

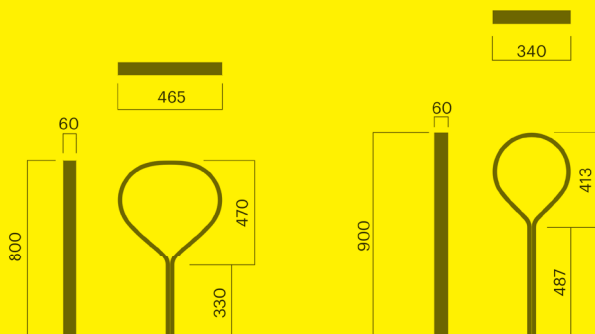

## Forum



### Forum benk

Forankring A eller C		kg CO <sub>2</sub> e	MJ	kg
Art. 2502-900A	<b>10 900 NOK</b>	120	1 831	46
Art. 2502-901A	<b>9 500 NOK</b>	120	1 831	46
Art. 2502-900C	<b>10 500 NOK</b>	132	1 996	50
Art. 2502-901C	<b>9 100 NOK</b>	132	1 996	50

Frittstående		kg CO <sub>2</sub> e	MJ	kg
Art. 2502-900	<b>13 100 NOK</b>	150	2 249	56
Art. 2502-901	<b>12 000 NOK</b>	150	2 249	56

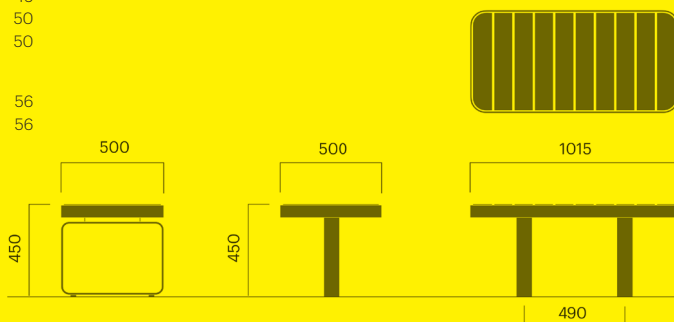

## Forum benk

Forankring A eller C		kg CO <sub>2</sub> e	MJ	kg
Art. 2503-900A	16 300 NOK	196	3 056	68
Art. 2503-901A	14 300 NOK	196	3 056	68
Art. 2503-900C	15 800 NOK	177	2 793	72
Art. 2503-901C	13 800 NOK	177	2 793	72

### Frittstående

Art. 2503-900	19 500 NOK	196	3 056	78
Art. 2503-901	16 900 NOK	196	3 056	78

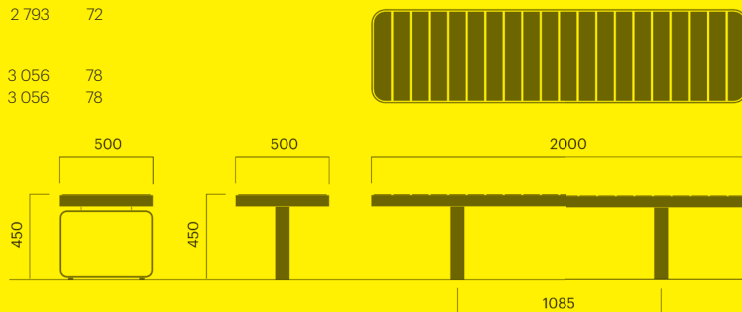

## Forum benk

Forankring A eller C		kg CO <sub>2</sub> e	MJ	kg
Art. 2504-900A	21 300 NOK	215	3 497	93
Art. 2504-901A	17 700 NOK	215	3 497	93
Art. 2504-900C	20 900 NOK	227	3 666	97
Art. 2504-901C	17 200 NOK	227	3 666	97

### Frittstående

Art. 2504-900	24 100 NOK	246	3 929	103
Art. 2504-901	21 200 NOK	246	3 929	103

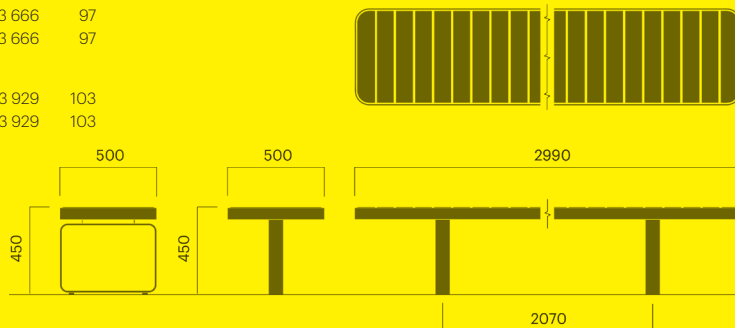

## Forum armlene og rygg

Rygg til 2 og 3 meter benk		kg CO <sub>2</sub> e	MJ	kg
Art. 2522-900	6 000 NOK	31	498	13
Art. 2522-901	4 700 NOK	31	498	12

### Armlene

Art. 2525-900	1 700 NOK	10	133	3
Art. 2525-901	1 400 NOK	10	133	3

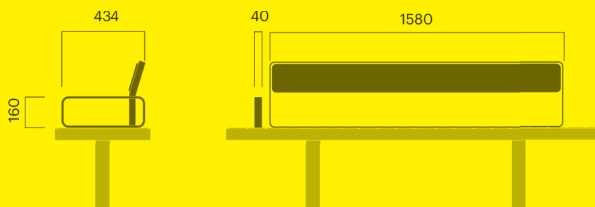

## Forum bord

1 meter

Frittstående		kg CO <sub>2</sub> e	MJ	kg
Art. 2532-900	<b>13 700 NOK</b>	173	2 571	63
Art. 2532-901	<b>12 600 NOK</b>	173	2 571	62

Forankring A eller C

Art. 2532-900A	<b>11 200 NOK</b>	135	2 041	51
Art. 2532-901A	<b>9 800 NOK</b>	135	2 041	51
Art. 2532-900C	<b>10 600 NOK</b>	146	2 200	55
Art. 2532-901C	<b>9 200 NOK</b>	146	2 200	55

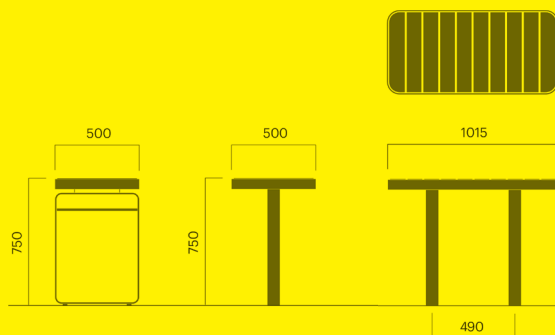

## Forum bord

2 meter

Frittstående		kg CO <sub>2</sub> e	MJ	kg
Art. 2533-900	<b>21 200 NOK</b>	221	3 413	86
Art. 2533-901	<b>19 000 NOK</b>	221	3 413	87

Forankring A eller C

Art. 2533-900A	<b>18 000 NOK</b>	180	2 841	73
Art. 2533-901A	<b>14 900 NOK</b>	180	2 841	73
Art. 2533-900C	<b>17 300 NOK</b>	204	3 174	77
Art. 2533-901C	<b>14 600 NOK</b>	204	3 174	77

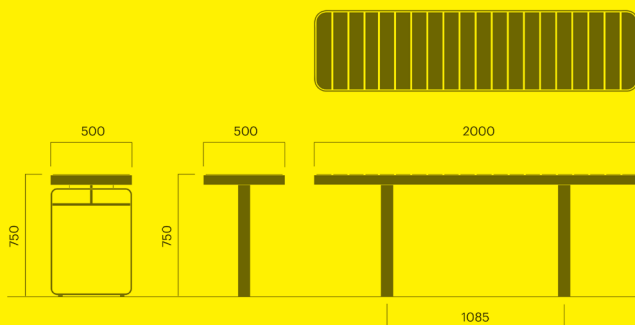

## Forum bord

3 meter

Frittstående, B500		kg CO <sub>2</sub> e	MJ	kg
Art. 2534-900	<b>26 100 NOK</b>	267	4 213	111
Art. 2534-901	<b>22 300 NOK</b>	267	4 213	112

Frittstående, B750

Art. 2536-900	<b>31 900 NOK</b>	387	6 135	120
Art. 2536-901	<b>26 200 NOK</b>	387	6 135	120

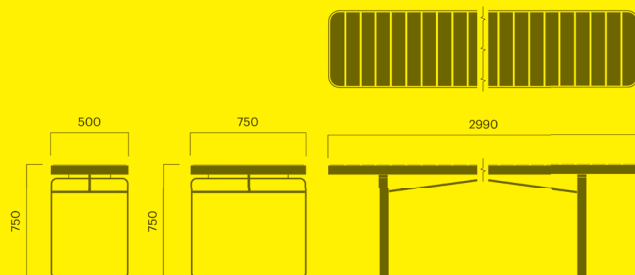

## Forum bord

3 meter

	Forankring A eller C, B500	kg CO <sub>2</sub> e	MJ	kg
Art. 2534-900A	21 600 NOK	230	3 708	98
Art. 2534-901A	19 000 NOK	230	3 708	98
Art. 2534-900C	21 000 NOK	242	3 868	102
Art. 2534-901C	18 400 NOK	242	3 868	102

Forankring A eller C, B750

Art. 2536-900A	27 700 NOK	272	4 531	79
Art. 2536-901A	25 300 NOK	272	4 531	79
Art. 2536-900C	27 100 NOK	269	4 493	78
Art. 2536-901C	24 400 NOK	269	4 493	78

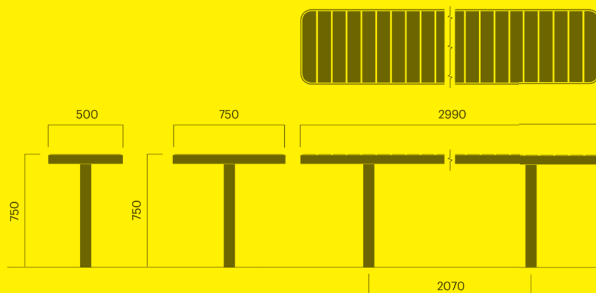

## Forum avfallsbeholder

130 liter

		kg CO <sub>2</sub> e	MJ	kg
Art. 2542-900	18 100 NOK	180	2 475	85
Art. 2542-901	15 200 NOK	180	2 475	85
Art. 2543-900	18 100 NOK	183	2 521	86
Art. 2543-901	15 200 NOK	183	2 521	86
Art. 2544-900	18 100 NOK	174	2 394	85
Art. 2544-901	15 200 NOK	174	2 394	85
Art. 2545-900	18 100 NOK	175	2 404	84
Art. 2545-901	15 200 NOK	175	2 404	84

Med innkast fra siden

Art. 2546-900	18 100 NOK	203	2 802	94
Art. 2546-901	15 200 NOK	203	2 802	94

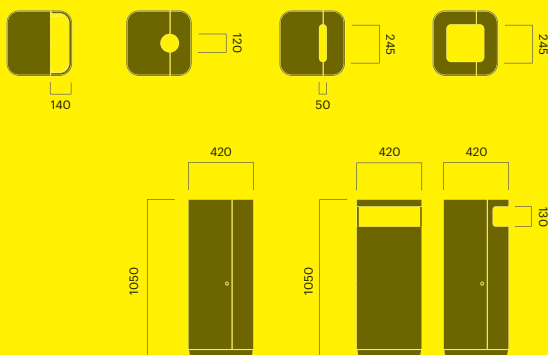

## Forum sykkelstativ for 2 sykler

Forankring A eller C

	Liten	kg CO <sub>2</sub> e	MJ	kg
Art. 2584-904A	3 700 NOK	18	309	10
Art. 2584-904C	3 400 NOK	21	361	5

	Stor	kg CO <sub>2</sub> e	MJ	kg
Art. 2586-904A	4 900 NOK	28	464	9
Art. 2586-904C	3 700 NOK	21	361	13



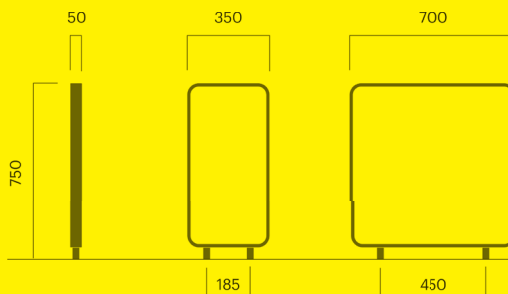

## Hill avfallsbeholder

2x70 liter

		kg CO <sub>2</sub> e	MJ	kg
<b>2 rom for kildesortering</b>				
Art. 6342-900	<b>16 500 NOK</b>	203	2 828	64
Art. 6342-901	<b>14 500 NOK</b>	203	2 828	63

140 liter

**1 rom for kildesortering**

Art. 6344-900	<b>15 600 NOK</b>	200	2 793	64
Art. 6344-901	<b>13 600 NOK</b>	200	2 793	63

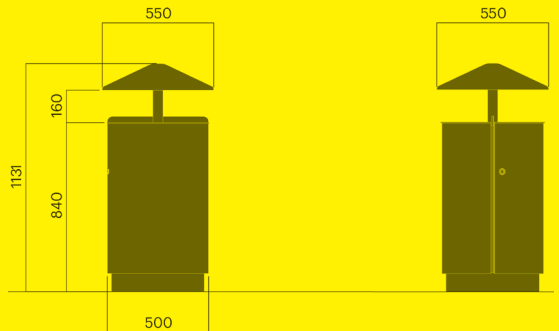

## Hvilan



### Hvilan krakk

		kg CO <sub>2</sub> e	MJ	kg
Art. 106-900	<b>8 500 NOK</b>	107	1 680	44
Art. 106-901	<b>7 300 NOK</b>	107	1 680	43

**Tillegg: rørforlenger for nedstøp**

Art. 101-901	<b>500 NOK</b>	5	71	2
--------------	----------------	---	----	---





## Hvilan benk

		kg CO <sub>2</sub> e	MJ	kg
Art. 116-900	<b>13 800 NOK</b>	140	2 284	59
Art. 116-901	<b>10 800 NOK</b>	140	2 284	59

### Tillegg: rørforlenger for nedstøp

Art. 101-901	<b>500 NOK</b>	5	71	2
--------------	----------------	---	----	---

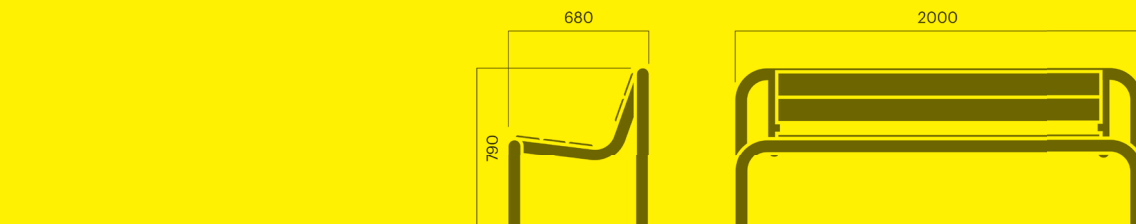

## Hvilan bord

		kg CO <sub>2</sub> e	MJ	kg
Art. 133-900	<b>11 400 NOK</b>	134	2 194	59
Art. 133-901	<b>9 700 NOK</b>	134	2 194	59

### Tillegg: rørforlenger for nedstøp

Art. 101-901	<b>500 NOK</b>	5	71	2
--------------	----------------	---	----	---

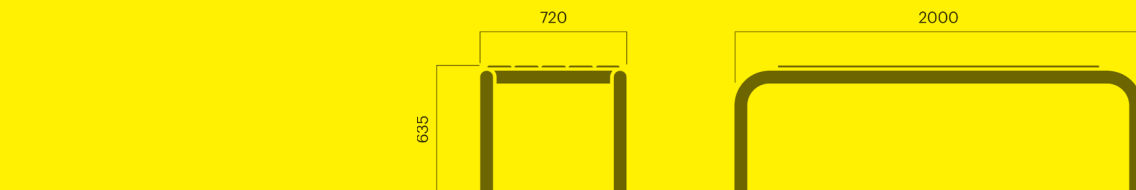

## Hvilan benkebord

		kg CO <sub>2</sub> e	MJ	kg
Art. 122-900	<b>18 500 NOK</b>	161	2 868	69
Art. 122-901	<b>16 500 NOK</b>	161	2 868	69

### Med plass for rullestol

Art. 122-900HC	<b>19 500 NOK</b>	140	2 754	76
Art. 122-901HC	<b>16 900 NOK</b>	140	2 754	76



## Hvilan stammevern

### D900

		kg CO <sub>2</sub> e	MJ	kg
Art. 153-900	8 800 NOK	129	1 797	43
Art. 153-901	6 800 NOK	129	1 797	43

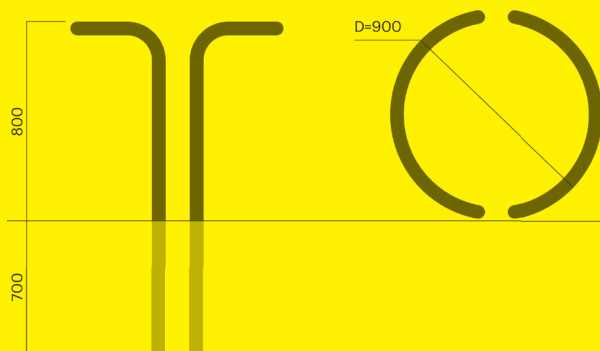

## Hvilan sperrepullert

Versjon A og C er styrkeberegnet og dimensjonert for å stoppe 3,5 tonn i 30 km/t

Forankring A		kg CO <sub>2</sub> e	MJ	kg
Art. 185-900A	11 600 NOK	154	2 149	80
Art. 185-901A	10 600 NOK	154	2 149	80
Forankring C				
Art. 185-900C	8 500 NOK	154	2 149	62
Art. 185-901C	6 800 NOK	154	2 149	62
Demonterbar				
Art. 185-900D	11 600 NOK	157	2 191	58
Art. 185-901D	10 600 NOK	157	2 191	58

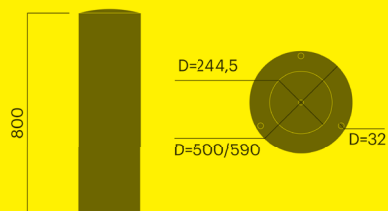

## Kong



### Kong cube

Frittstående		kg CO <sub>2</sub> e	MJ	kg
Art. 4010-900	13 400 NOK	74	1 336	38
Art. 4010-901	11 600 NOK	74	1 336	38
Forankring nedstøpt				
Art. 4010-900C	13 800 NOK	88	1 529	43
Art. 4010-901C	12 000 NOK	88	1 529	43

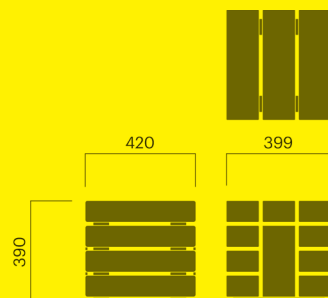

## Kong krakk

Forankring A eller C		kg CO <sub>2</sub> e	MJ	kg
Art. 4003-900A	<b>18 400 NOK</b>	166	3 289	102
Art. 4003-901A	<b>15 800 NOK</b>	166	3 289	102
Art. 4003-900C	<b>19 000 NOK</b>	203	3 797	114
Art. 4003-901C	<b>16 300 NOK</b>	203	3 797	114

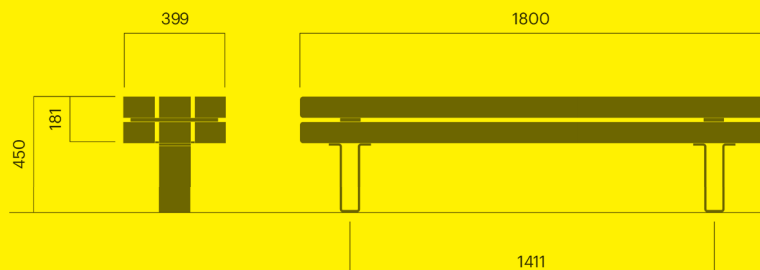

## Kong rygg

		kg CO <sub>2</sub> e	MJ	kg
Art. 4021-900	<b>8 300 NOK</b>	50	888	25
Art. 4021-901	<b>7 700 NOK</b>	50	888	25

### Armlene

Art. 4025-900	<b>2 100 NOK</b>	16	229	5
Art. 4025-901	<b>1 900 NOK</b>	16	229	5

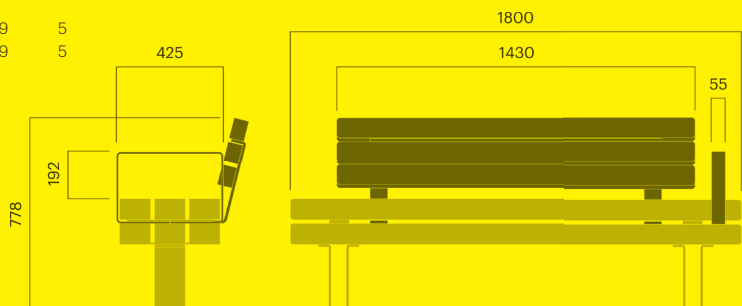

## Kong solbenk

Forankring A eller C		kg CO <sub>2</sub> e	MJ	kg
Art. 4066-900A	<b>42 600 NOK</b>	335	5 662	163
Art. 4066-901A	<b>40 200 NOK</b>	335	5 662	163
Art. 4066-900C	<b>42 600 NOK</b>	407	6 661	182
Art. 4066-901C	<b>40 200 NOK</b>	407	6 661	182

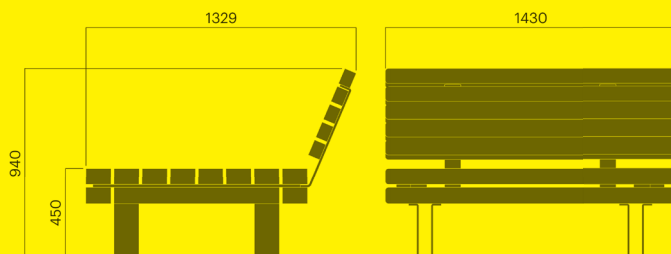

## Kong bord

Forankring A eller C		kg CO <sub>2</sub> e	MJ	kg
Art. 4033-900A	<b>19 800 NOK</b>	340	5 128	125
Art. 4033-901A	<b>17 700 NOK</b>	340	5 128	125
Art. 4033-900C	<b>21 000 NOK</b>	396	5 898	144
Art. 4033-901C	<b>18 800 NOK</b>	396	5 898	144

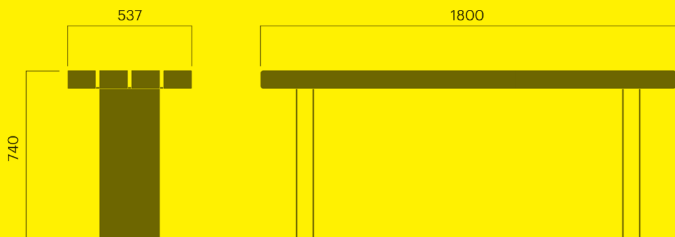

## Kyoto



### Kyoto krakk

		kg CO <sub>2</sub> e	MJ	kg
Art. 2206-004	<b>18 000 NOK</b>	39	1 399	165
<b>Armlenesett for krakk</b>				
Art. 2226-900	<b>4 200 NOK</b>	16	221	5
Art. 2226-901	<b>3 600 NOK</b>	16	221	5

Skal boltes fast i underlaget.

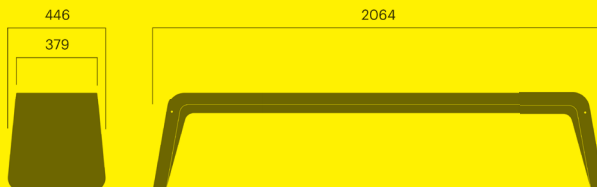

## Kyoto bank

		kg CO <sub>2</sub> e	MJ	kg
Art. 2216-004	<b>25 500 NOK</b>	72	2 586	305

### Armlenesett for bank

Art. 2225-900	<b>4 200 NOK</b>	16	221	19
Art. 2225-901	<b>3 600 NOK</b>	16	221	5

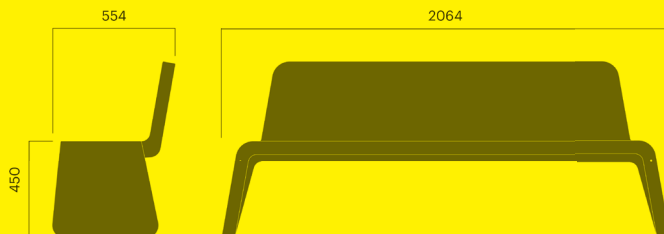

## Kyoto bord

		kg CO <sub>2</sub> e	MJ	kg
Art. 2236-004	<b>30 500 NOK</b>	105	3 773	445

Skal boltes fast i underlaget.

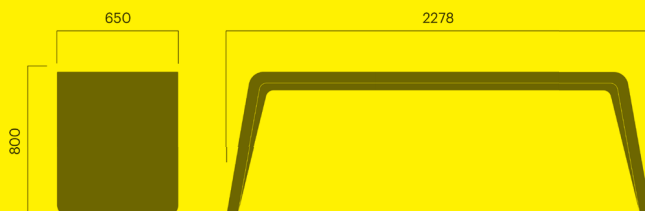

## Move



### Move krakk

		kg CO <sub>2</sub> e	MJ	kg
Art. 3106-900	<b>19 800 NOK</b>	215	3 375	87
Art. 3106-901	<b>18 100 NOK</b>	215	3 375	87

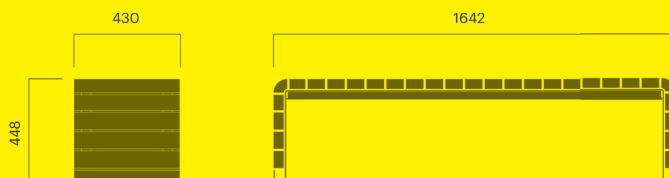



## Munch stabelbar kaféstol

		kg CO <sub>2</sub> e	MJ	kg
Art. 5113-900	3 900 NOK	36	497	11
Art. 5113-901	3 200 NOK	36	497	11

Puter på forespørsel.

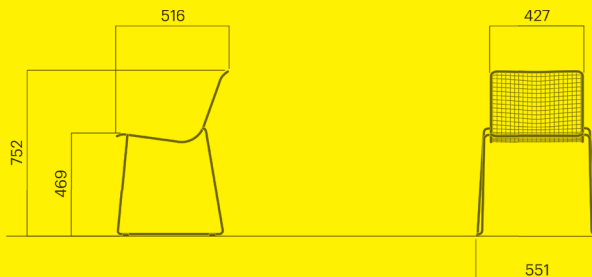

## Munch loungestol

		kg CO <sub>2</sub> e	MJ	kg
Art. 5166-900	9 800 NOK	73	1 015	23
Art. 5166-901	8 600 NOK	73	1 015	23

Puter på forespørsel.

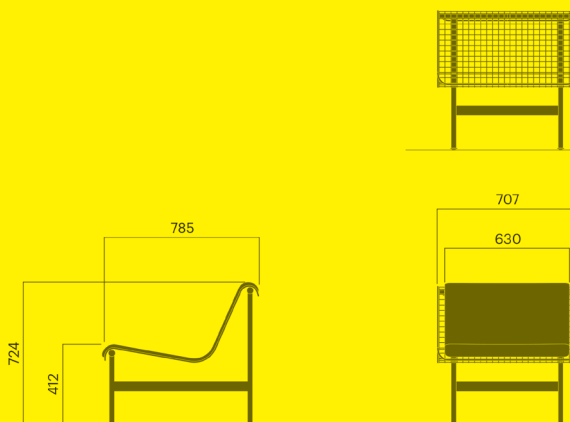

## Munch loungestol

		kg CO <sub>2</sub> e	MJ	kg
Med armlene				
Art. 5167-900	12 800 NOK	86	1 205	32
Art. 5167-901	10 500 NOK	86	1 205	32

Puter på forespørsel.

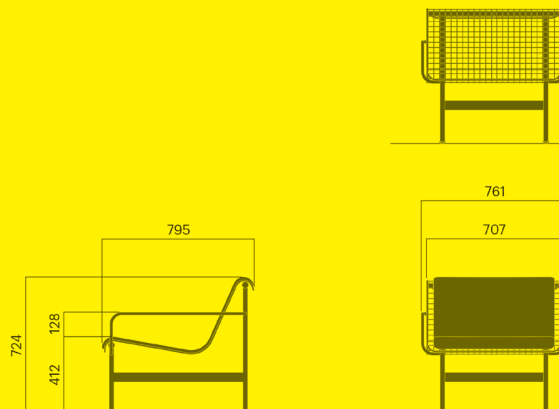

## Munch krakk

3-seter		kg CO <sub>2</sub> e	MJ	kg
Art. 5106-900	<b>10 800 NOK</b>	110	1 539	35
Art. 5106-901	<b>9 200 NOK</b>	110	1 539	35

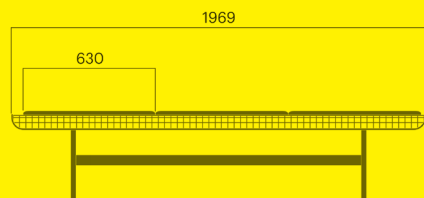
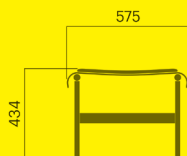
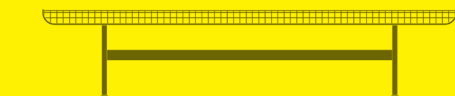

## Munch benk

3-seter		kg CO <sub>2</sub> e	MJ	kg
Art. 5116-900	<b>13 600 NOK</b>	142	1 976	45
Art. 5116-901	<b>12 400 NOK</b>	142	1 976	45

Puter på forespørsel

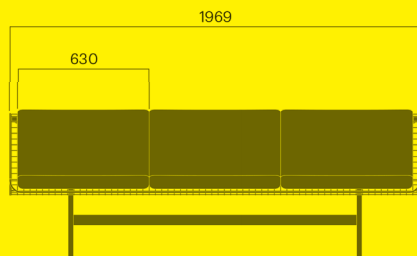
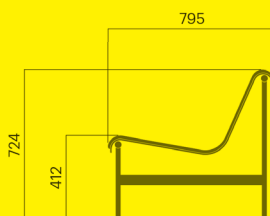
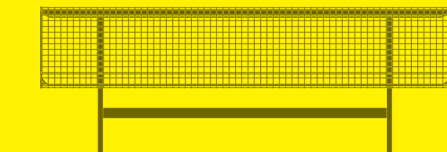

## Munch benk

3-seter		kg CO <sub>2</sub> e	MJ	kg
Art. 5117-900	<b>16 600 NOK</b>	153	2 136	49
Art. 5117-901	<b>14 200 NOK</b>	153	2 136	49

Puter på forespørsel

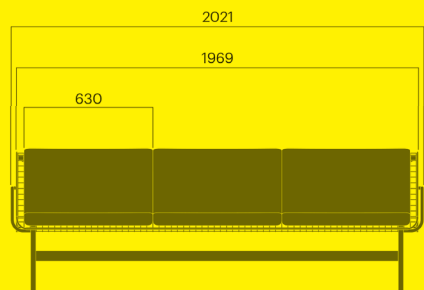
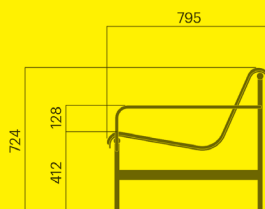
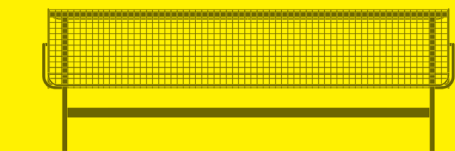

## Munch kafébord

		kg CO <sub>2</sub> e	MJ	kg
<b>Rundt</b>				
Art. 5132-900	5 200 NOK	113	1 577	31
Art. 5132-901	4 500 NOK	113	1 577	31
<b>Kvadratisk</b>				
Art. 5134-900	5 600 NOK	113	1 577	37
Art. 5134-901	4 800 NOK	113	1 577	37

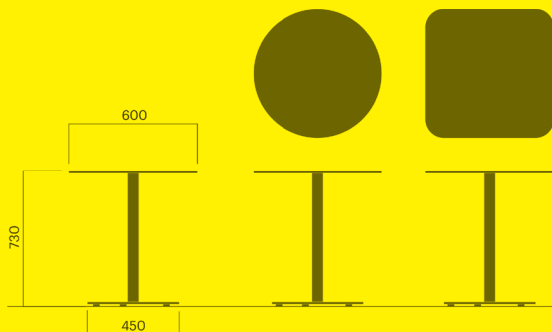

## Munch kafébord

		kg CO <sub>2</sub> e	MJ	kg
<b>Rundt, høyt</b>				
Art. 5137-900	5 500 NOK	100	1 394	32
Art. 5137-901	4 700 NOK	100	1 394	32
<b>Kvadratisk, høyt</b>				
Art. 5138-900	5 800 NOK	115	1 595	38
Art. 5138-901	5 100 NOK	115	1 595	38
<b>Rundt, lavt</b>				
Art. 5130-900	5 000 NOK	96	1 340	31
Art. 5130-901	4 300 NOK	96	1 340	31
<b>Kvadratisk, lavt</b>				
Art. 5131-900	5 400 NOK	112	1 556	37
Art. 5131-901	4 600 NOK	112	1 556	37

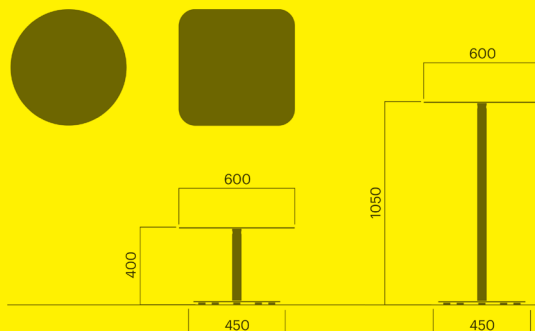

## Parc



### Parc stol

		kg CO <sub>2</sub> e	MJ	kg
Art. 2318-900	10 900 NOK	48	936	19
Art. 2318-901	9 600 NOK	48	936	19

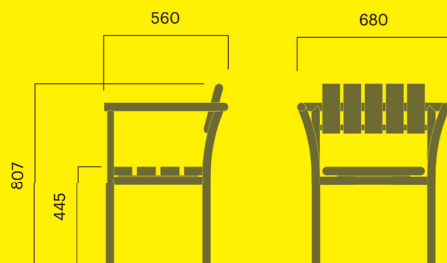



## Parc benk

		kg CO <sub>2</sub> e	MJ	kg
Art. 2317-900	15 700 NOK	77	1 594	49
Art. 2317-901	14 300 NOK	77	1 594	49

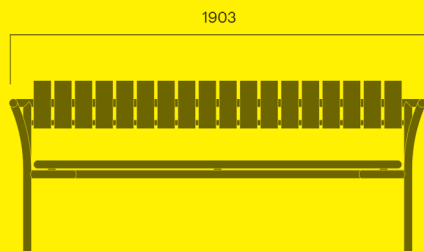

## Parc bord

		kg CO <sub>2</sub> e	MJ	kg
Art. 2336-900	12 500 NOK	42	817	35
Art. 2336-901	11 800 NOK	42	817	35

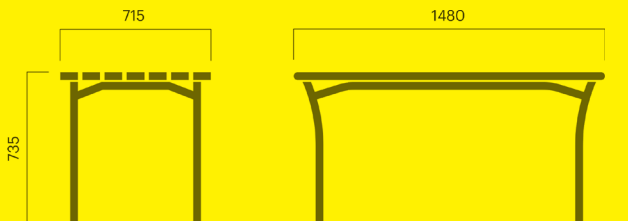

## Parklet 2.0



### Parklet Bygulv

Umøblert gulv med justerbare føtter inkludert gjerde og overgangsplate til fortau. Tilrettelagt for flytting med truck.

		kg CO <sub>2</sub> e	MJ	kg
Art. 4470-900	94 200 NOK	1907	30 345	786
Art. 4470-901	89 900 NOK	1907	30 345	786

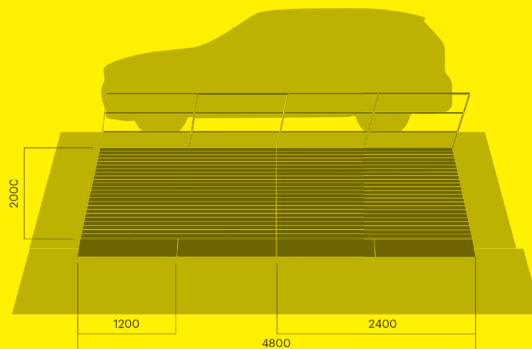

## Parklet Hygge

Ferdig møblert med gjerde, overgangsplater, plantekasse og solbenker. Tilrettelagt for flytting med truck.

		kg CO <sub>2</sub> e	MJ	kg
Art. 4473-900	<b>144 500 NOK</b>	2445	39 355	1060
Art. 4473-901	<b>139 100 NOK</b>	2445	39 355	1039

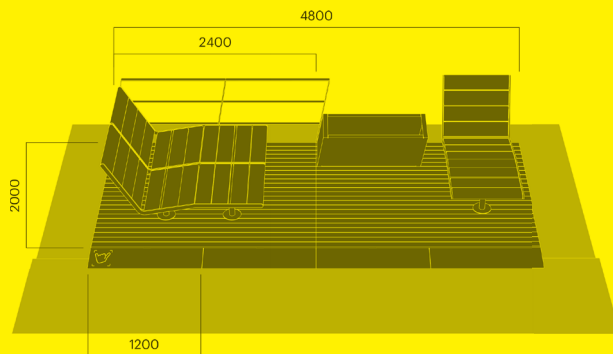

## Parklet Portal

Ferdig møblert med overgangsplater, sittemoduler med armene og plantekasser. Tilrettelagt for flytting med truck.

		kg CO <sub>2</sub> e	MJ	kg
Art. 4472-900	<b>155 200 NOK</b>	3071	46 965	1361
Art. 4472-901	<b>149 800 NOK</b>	3071	46 965	1182

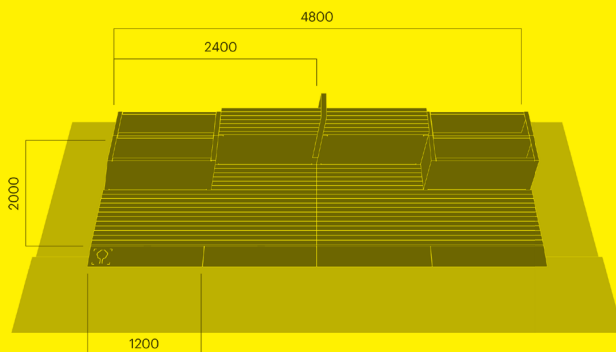

## Parklet Skog

Kombinasjon av lav og høy plantekasse med integrert benk. Tilrettelagt for flytting med truck.

		kg CO <sub>2</sub> e	MJ	kg
Art. 4474-900	<b>160 500 NOK</b>	3907	55 326	1233
Art. 4474-901	<b>149 800 NOK</b>	3907	55 326	1236

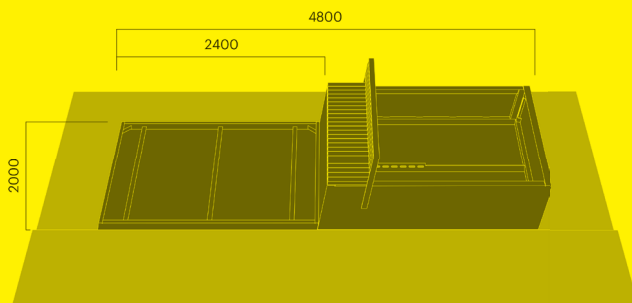

## Parklet Café

Ferdig møblert med gjerde, overgangsplater, sittemoduler, barløsning og plantekasse. Tilrettelagt for flytting med truck.

		kg CO <sub>2</sub> e	MJ	kg
Art. 4471-900	<b>203 300 NOK</b>	3566	52 678	1393
Art. 4471-901	<b>187 300 NOK</b>	3566	52 678	1599

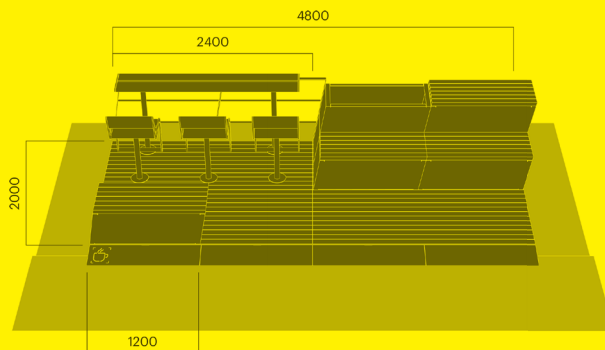

## Parklet gulv og gjerde

Tilrettelagt for flytting med truck

Gulv med justerbare føtter		kg CO <sub>2</sub> e	MJ	kg
Art. 4401-901	<b>31 600 NOK</b>	708	11 716	318

Gjerde lengde 1200 mm

Art. 4454-900	<b>4 700 NOK</b>	44	610	14
Art. 4454-901	<b>3 600 NOK</b>	44	610	14

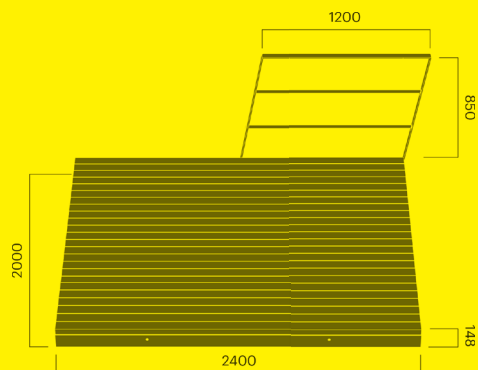

## Parklet overgangsplater

Overgangsplate uten ikon		kg CO <sub>2</sub> e	MJ	kg
Art. 4440-901	<b>3 900 NOK</b>	72	994	24

Overgangsplate med ikon

Art. 4441-901	<b>3 900 NOK</b>	67	918	22
Art. 4442-901	<b>3 900 NOK</b>	67	923	22
Art. 4443-901	<b>3 900 NOK</b>	67	918	22
Art. 4444-901	<b>3 900 NOK</b>	67	923	22
Art. 4445-901	<b>3 900 NOK</b>	67	923	22

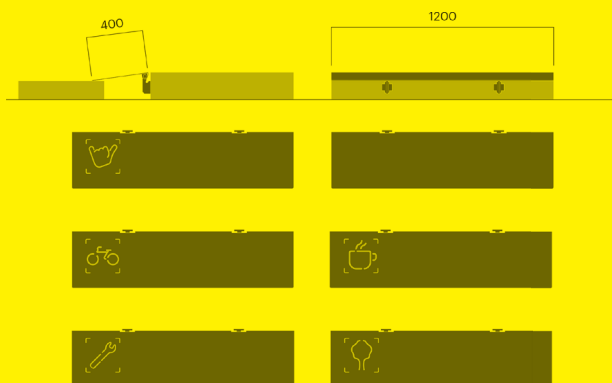

## Parklet Sykkel

Sykkelparkering med justerbare føtter og overgangsplater. Tilrettelagt for flytting med truck.

		kg CO <sub>2</sub> e	MJ	kg
<b>6 sykler</b>				
Art. 4475-900	45 000 NOK	1273	17 912	404
<b>12 sykler</b>				
Art. 4476-900	90 000 NOK	3242	45 515	809

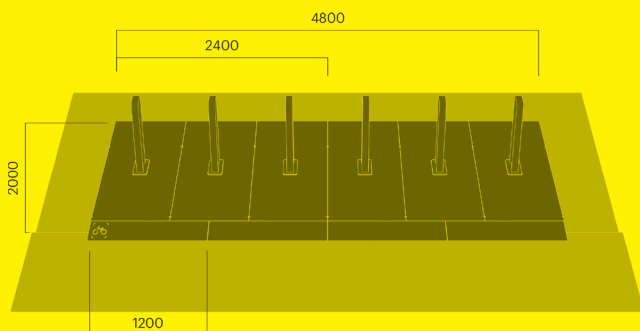

## Parklet Mekk

Gulv med justerbare føtter inkludert mekkestativ, sittemodul og overgangsplate til fortau. Tilrettelagt for flytting med truck.

		kg CO <sub>2</sub> e	MJ	kg
Art. 4477-900	92 000 NOK	1273	17 912	511

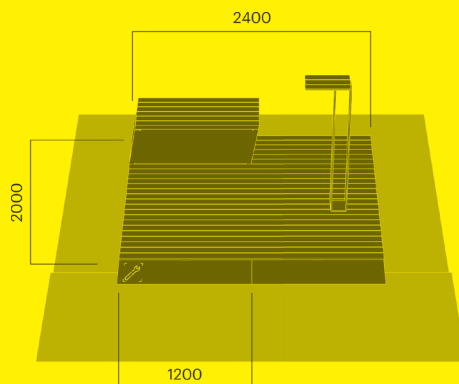

## Parklet sittemodul

		kg CO <sub>2</sub> e	MJ	kg
Art. 4406-900	14 400 NOK	216	3 243	79
Art. 4406-901	12 700 NOK	216	3 243	79
<b>Med armene</b>				
Art. 4407-900	15 800 NOK	229	3 422	115
Art. 4407-901	14 300 NOK	229	3 422	115
<b>Uten tre</b>				
Art. 4403-900	9 500 NOK	189	2 630	60
Art. 4403-901	8 300 NOK	189	2 630	60

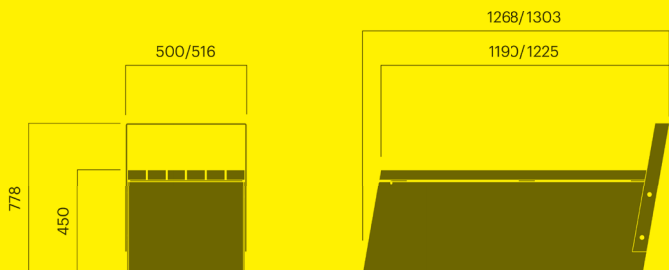

## Parklet liten plantekasse

Leveres med integrert vannreservoar og drenering

		kg CO <sub>2</sub> e	MJ	kg
Art. 4488-900	11 600 NOK	227	3 161	72
Art. 4488-901	10 500 NOK	227	3 161	72

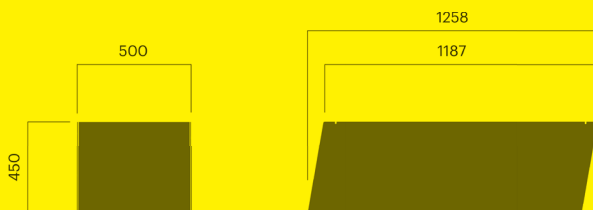

## Parklet stor plantekasse

Lav		kg CO <sub>2</sub> e	MJ	kg
Art. 4486-901	43 900 NOK	1210	16 876	383

Høy		kg CO <sub>2</sub> e	MJ	kg
Art. 4480-900	91 000 NOK	2070	28 901	734
Art. 4480-901	83 500 NOK	2070	28 901	734

Sittekant		kg CO <sub>2</sub> e	MJ	kg
Art. 4420-900MK	15 200 NOK	176	2 848	75
Art. 4420-901MK	14 100 NOK	176	2 848	76

Rygg		kg CO <sub>2</sub> e	MJ	kg
Art. 4421-900	11 600 NOK	101	1 607	42
Art. 4421-901	10 400 NOK	101	1 607	42

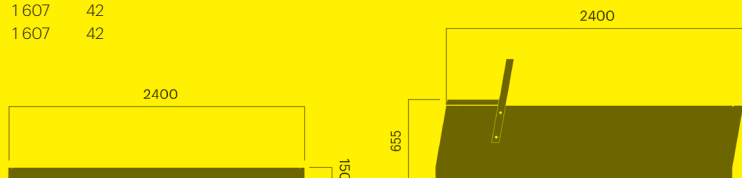

## Plinth



### Plinth krakk

H250 forankring A og C		kg CO <sub>2</sub> e	MJ	kg
Art. 5603-900A	7 900 NOK	63	1 011	34
Art. 5603-901A	6 800 NOK	63	1 011	34
Art. 5603-900c	8 000 NOK	126	1 887	34
Art. 5603-901c	7 000 NOK	126	1 887	34

H450 forankring A og C		kg CO <sub>2</sub> e	MJ	kg
Art. 5604-900A	10 200 NOK	112	1 690	52
Art. 5604-901A	8 800 NOK	112	1 690	49
Art. 5604-900C	10 200 NOK	167	2 459	71
Art. 5604-901C	8 800 NOK	167	2 459	34

H740 forankring A og C		kg CO <sub>2</sub> e	MJ	kg
Art. 5605-900A	12 700 NOK	162	2 393	58
Art. 5605-901A	11 000 NOK	162	2 393	58
Art. 5605-900C	12 700 NOK	227	3 294	58
Art. 5605-901C	11 000 NOK	227	3 294	58

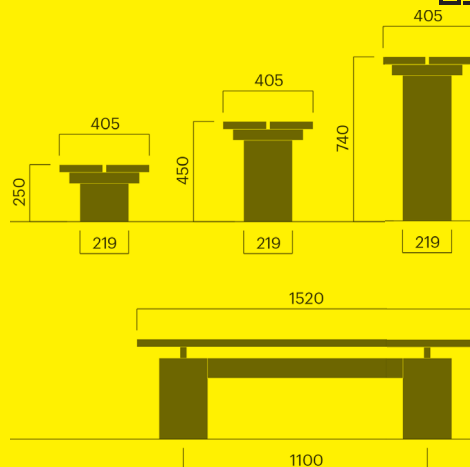

## Plinth lang krakk

H250 forankring A og C		kg CO <sub>2</sub> e	MJ	kg
Art. 5606-900A	12 700 NOK	91	1 504	50
Art. 5606-901A	11 300 NOK	91	1 504	50
Art. 5606-900C	12 700 NOK	188	2 860	50
Art. 5606-901C	11 300 NOK	188	2 860	50
H450 forankring A og C		kg CO <sub>2</sub> e	MJ	kg
Art. 5607-900A	14 900 NOK	153	2 367	71
Art. 5607-901A	12 700 NOK	153	2 367	71
Art. 5607-900C	14 900 NOK	250	3 724	71
Art. 5607-901C	12 700 NOK	250	3 724	71
H740 forankring A og C		kg CO <sub>2</sub> e	MJ	kg
Art. 5608-900A	16 800 NOK	243	3 620	89
Art. 5608-901A	14 400 NOK	243	3 620	89
Art. 5608-900C	16 800 NOK	340	4 975	89
Art. 5608-901C	14 400 NOK	340	4 975	89

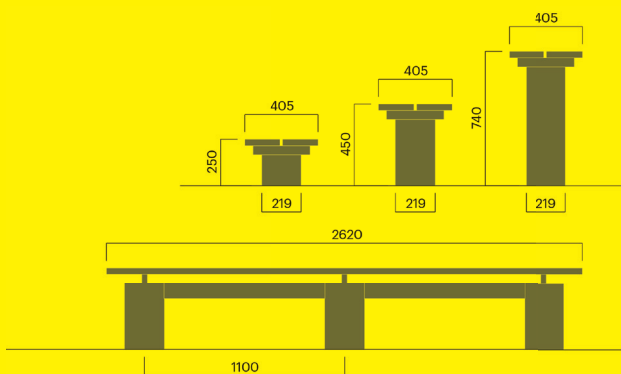

## Plinth benk

Forankring A og C		kg CO <sub>2</sub> e	MJ	kg
Art. 5613-900A	12 700 NOK	145	2 149	64
Art. 5613-901A	10 600 NOK	145	2 149	64
Art. 5613-900C	12 700 NOK	214	3 111	75
Art. 5613-901C	10 600 NOK	214	3 111	75

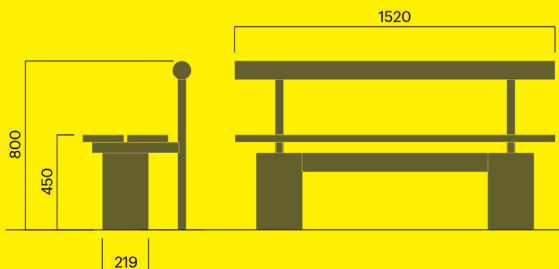

## Plinth lang benk

Forankring A og C		kg CO <sub>2</sub> e	MJ	kg
Art. 5614-900A	21 200 NOK	224	3 353	83
Art. 5614-901A	18 100 NOK	224	3 353	83
Art. 5614-900C	21 200 NOK	327	4 794	116
Art. 5614-901C	18 100 NOK	327	4 794	116

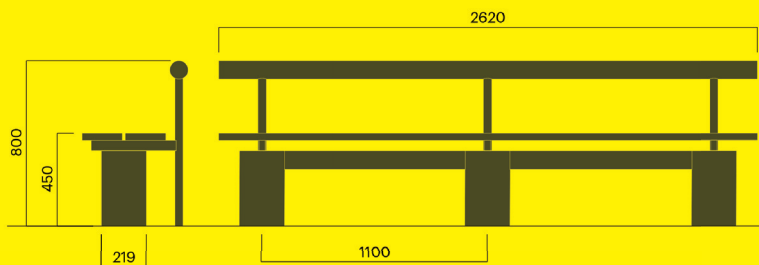

## Plinth bord

H250 forankring A og C		kg CO <sub>2</sub> e	MJ	kg
Art. 5632-900A	8 800 NOK	66	1 116	34
Art. 5632-901A	7 700 NOK	66	1 116	34
Art. 5632-900C	8 800 NOK	131	2 018	65
Art. 5632-901C	7 700 NOK	131	2 018	65

### H450 forankring A og C

Art. 5633-900A	10 900 NOK	107	1 689	56
Art. 5633-901A	9 100 NOK	107	1 689	56
Art. 5633-900C	10 900 NOK	168	2 528	52
Art. 5633-901C	9 100 NOK	168	2 528	52

### H740 forankring A og C

Art. 5634-900A	12 700 NOK	168	2 528	80
Art. 5634-901A	10 900 NOK	168	2 528	80
Art. 5634-900C	12 700 NOK	208	3 096	99
Art. 5634-901C	10 900 NOK	208	3 096	99

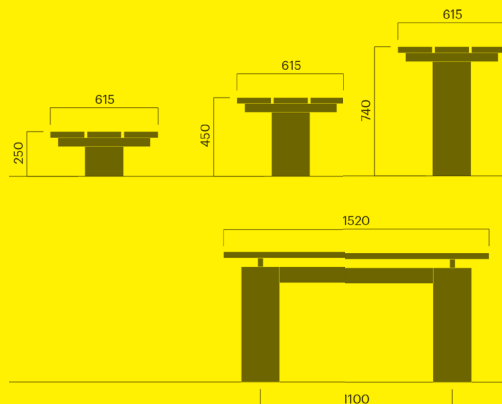

## Plinth langt bord

H250 forankring A og C		kg CO <sub>2</sub> e	MJ	kg
Art. 5635-900A	14 300 NOK	100	1 729	59
Art. 5635-901A	12 700 NOK	100	1 729	59
Art. 5635-900C	14 200 NOK	197	3 085	93
Art. 5635-901C	12 700 NOK	197	3 085	93

### H450 forankring A og C

Art. 5636-900A	16 300 NOK	162	2 592	79
Art. 5636-901A	14 600 NOK	162	2 592	79
Art. 5636-900C	16 300 NOK	259	3 949	114
Art. 5636-901C	14 600 NOK	259	3 949	114

### H740 forankring A og C

Art. 5637-900A	18 400 NOK	252	3 850	111
Art. 5637-901A	15 800 NOK	252	3 850	111
Art. 5637-900C	18 400 NOK	349	5 200	128
Art. 5637-901C	15 800 NOK	349	5 200	128

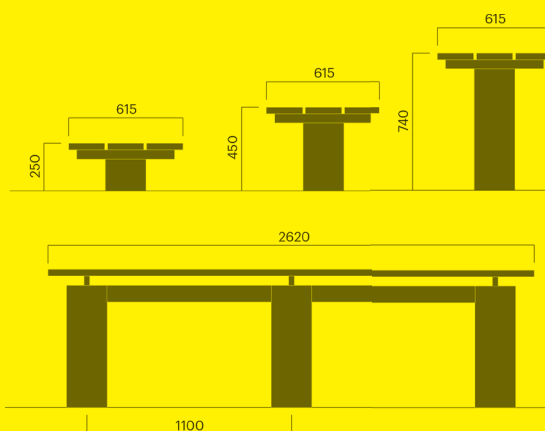

## Plinth sykkelstativ

Forankring A og C		kg CO <sub>2</sub> e	MJ	kg
Art. 5686-900A	4 000 NOK	43	600	15
Art. 5686-901A	2 800 NOK	43	600	15
Art. 5686-900C	4 000 NOK	41	573	14
Art. 5686-901C	3 500 NOK	41	573	13

### Plinth sykkelstativ lang

Art. 5687-900A	4 600 NOK	77	1 079	27
Art. 5687-901A	5 000 NOK	77	1 079	27
Art. 5687-900C	5 000 NOK	69	957	26
Art. 5687-901C	4 000 NOK	69	957	26

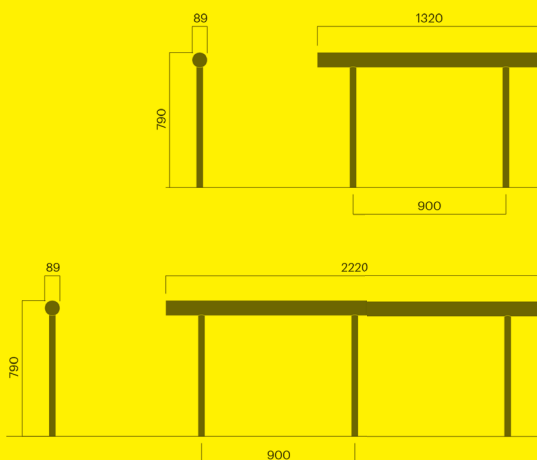

# Pop



## Pop krakk

		kg CO <sub>2</sub> e	MJ	kg
Art. 3806-900	<b>9 800 NOK</b>	63	910	24
Art. 3806-901	<b>6 200 NOK</b>	63	910	24

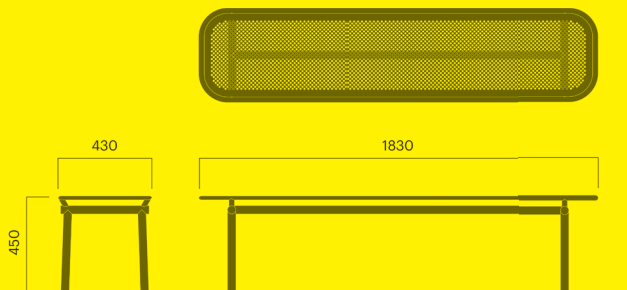

## Pop benk

		kg CO <sub>2</sub> e	MJ	kg
Art. 3816-900	<b>14 200 NOK</b>	101	1 462	37
Art. 3816-901	<b>10 100 NOK</b>	101	1 462	37

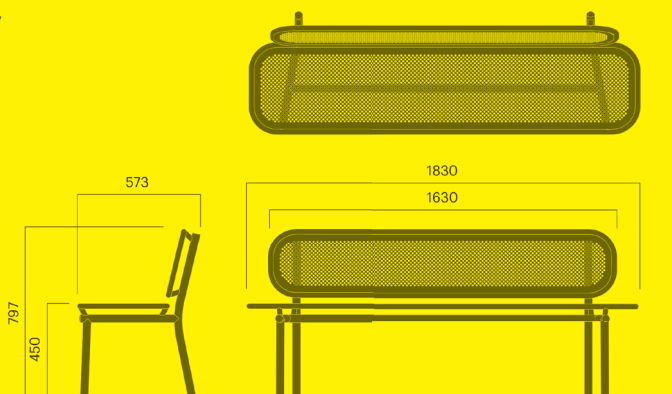



## Pop benk med armlene

		kg CO <sub>2</sub> e	MJ	kg
Art. 3817-900	<b>15 800 NOK</b>	108	1 565	37
Art. 3817-901	<b>13 800 NOK</b>	108	1 565	37

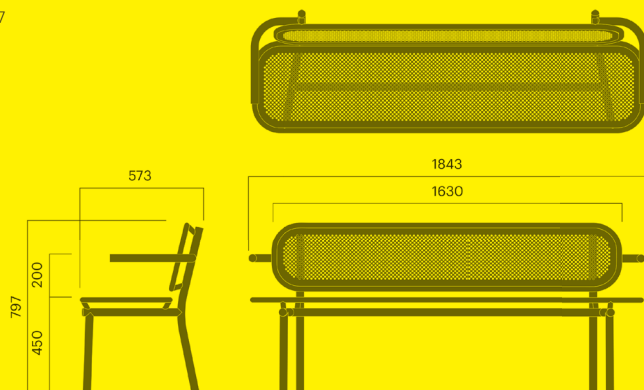

## Pop bord

		kg CO <sub>2</sub> e	MJ	kg
Art. 3836-900	<b>9 600 NOK</b>	88	1 286	42
Art. 3836-901	<b>7 900 NOK</b>	88	1 286	42

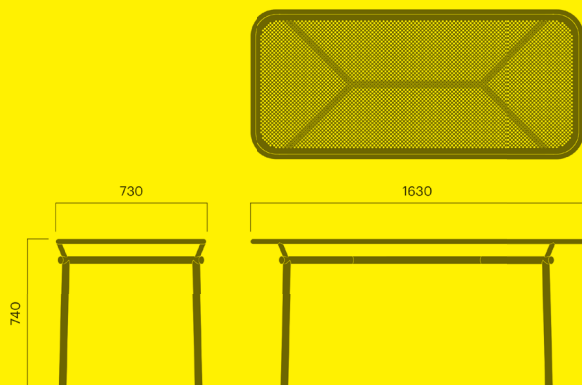

## Pop plantekasse

### 110 liter

Lav		kg CO <sub>2</sub> e	MJ	kg
Art. 3880-900	<b>11 600 NOK</b>	277	3 857	135
Art. 3880-901	<b>9 800 NOK</b>	277	3 857	41

### 210 liter

Høy		kg CO <sub>2</sub> e	MJ	kg
Art. 3882-900	<b>16 500 NOK</b>	457	6 357	135
Art. 3882-901	<b>14 500 NOK</b>	457	6 357	128

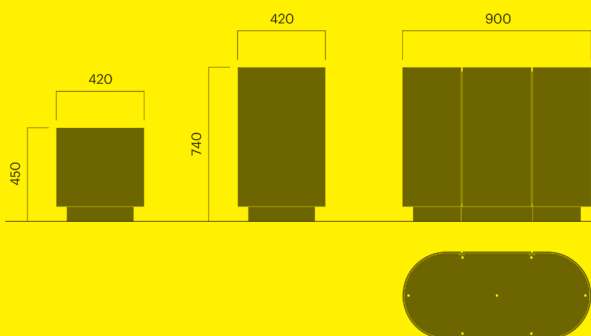

## Pop plantekasse

### 240 liter

		kg CO <sub>2</sub> e	MJ	kg
Art. 3884-900	22 500 NOK	567	7 892	167
Art. 3884-901	19 800 NOK	567	7 892	148

### 440 liter

#### Høy, tilrettelagt for valgfri byvegg

Art. 3886-900	26 800 NOK	819	11 401	246
Art. 3886-901	23 800 NOK	819	11 401	246

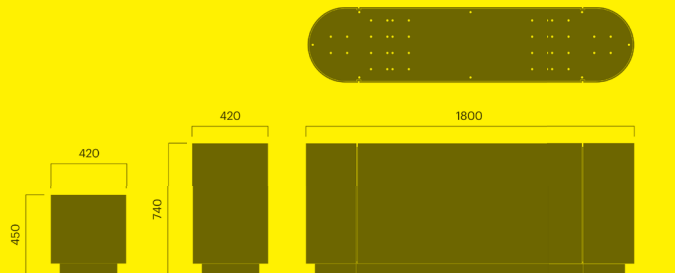

## Pop byvegg #1

		kg CO <sub>2</sub> e	MJ	kg
Art. 3870-900A	13 100 NOK	114	1 681	35
Art. 3870-901A	11 100 NOK	114	1 681	35

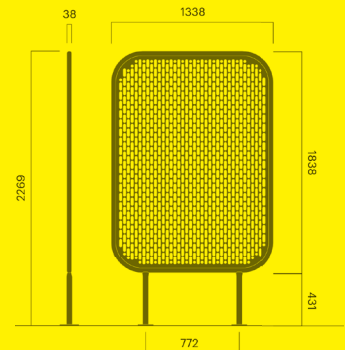

## Pop byvegg #2

		kg CO <sub>2</sub> e	MJ	kg
Art. 3872-900A	14 900 NOK	128	1 899	46
Art. 3872-901A	12 900 NOK	128	1 899	46

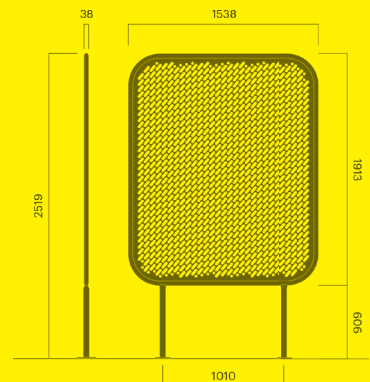

## Pop byvegg #3

		kg CO <sub>2</sub> e	MJ	kg
Art. 3874-900A	14 000 NOK	128	1 881	44
Art. 3874-901A	12 000 NOK	128	1 881	44

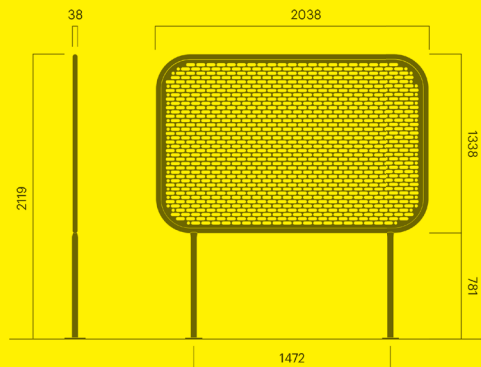

## Porto



### Porto benk A

		kg CO <sub>2</sub> e	MJ	kg
<b>Frittstående</b>				
Art. 401-900	24 500 NOK	135	2 931	91
Art. 401-901	23 000 NOK	135	2 931	91
<b>For murkant</b>				
Art. 401-901MK	19 800 NOK	78	2 122	73



## Porto benk B

Frittstående		kg CO <sub>2</sub> e	MJ	kg
Art. 402-900	24 500 NOK	149	3 428	108
Art. 402-901	23 000 NOK	149	3 428	108
<b>For murkant</b>				
Art. 402-901MK	19 800 NOK	90	2 604	90



## Porto benk C

Frittstående		kg CO <sub>2</sub> e	MJ	kg
Art. 403-900	24 500 NOK	149	3 429	107
Art. 403-901	23 000 NOK	149	3 429	106
<b>For murkant</b>				
Art. 403-901MK	19 800 NOK	91	2 590	86



## Porto benk D

Frittstående		kg CO <sub>2</sub> e	MJ	kg
Art. 404-900	24 500 NOK	137	2 981	92
Art. 404-901	23 000 NOK	137	2 981	92
<b>For murkant</b>				
Art. 404-901MK	19 800 NOK	79	2 173	90



## Porto benk E

Frittstående		kg CO <sub>2</sub> e	MJ	kg
Art. 405-900	17 900 NOK	126	2 636	80
Art. 405-901	15 900 NOK	126	2 636	80
For murkant				
Art. 405-901MK	11 800 NOK	69	1 827	62

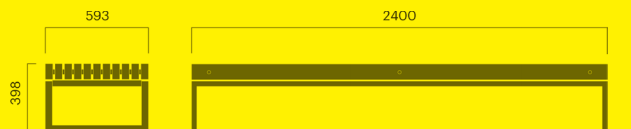

## Porto benk F

Frittstående		kg CO <sub>2</sub> e	MJ	kg
Art. 406-900	23 400 NOK	156	3 595	114
Art. 406-901	22 000 NOK	156	3 595	113
For murkant				
Art. 406-901MK	18 000 NOK	98	2 787	95



## Porto benk K

Frittstående		kg CO <sub>2</sub> e	MJ	kg
Art. 407-900	37 200 NOK	151	3 505	111
Art. 407-901	35 700 NOK	151	3 505	111
For murkant				
Art. 407-901MK	33 000 NOK	95	2 718	96



## Porto benk

For merkant

H: 135 mm		kg CO <sub>2</sub> e	MJ	kg
Art. 420-900MK	8 500 NOK	39	1 020	33
Art. 420-901MK	8 300 NOK	39	1 020	33

H: 187 mm		kg CO <sub>2</sub> e	MJ	kg
Art. 421-900MK	9 900 NOK	54	1 523	53
Art. 421-901MK	9 900 NOK	54	1 523	51

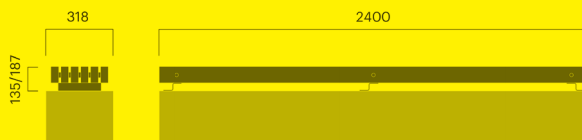

## Porto rygg og armene

Armlene		kg CO <sub>2</sub> e	MJ	kg
Art. 425-900E	2 100 NOK	8	116	3
Art. 425-901E	1 900 NOK	8	116	3

Rygg		kg CO <sub>2</sub> e	MJ	kg
Art. 423-900E	8 100 NOK	33	748	23
Art. 423-901E	7 300 NOK	33	748	23

Rygg og armene komplett		kg CO <sub>2</sub> e	MJ	kg
Art. 427-900	5 100 NOK	27	410	10
Art. 427-901	4 700 NOK	27	410	10
Art. 428-900	5 100 NOK	27	410	10
Art. 428-901	4 700 NOK	27	410	10



## Reale

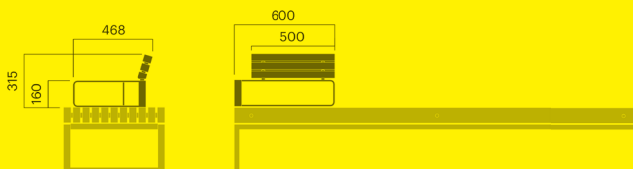

### Reale planteurne

130 liter		kg CO <sub>2</sub> e	MJ	kg
Art. rea 065-057	9 400 NOK	-	-	35



## Reale planteurne

340 liter                      kg CO<sub>2</sub>e      MJ      kg  
Art. rea 090-090      13 700 NOK      -      -      75

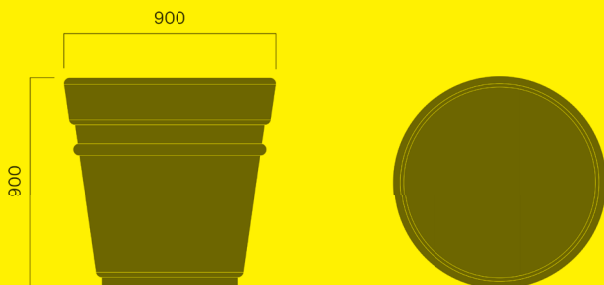

## Reale planteurne

600 liter                      kg CO<sub>2</sub>e      MJ      kg  
Art. rea 120-070      15 200 NOK      -      -      80



## Reale planteurne

1100 liter                      kg CO<sub>2</sub>e      MJ      kg  
Art. rea 130-130      29 400 NOK      -      -      140

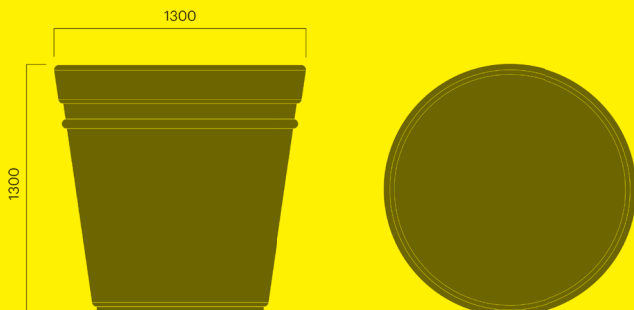



## Sinus sykkelstativ

For 5 sykler

Forankring A eller C		kg CO <sub>2</sub> e	MJ	kg
Art. 381-900A	5 000 NOK	64	866	18
Art. 381-901A	4 200 NOK	64	866	18
Art. 381-900C	4 200 NOK	65	889	18
Art. 381-901C	3 600 NOK	65	889	18

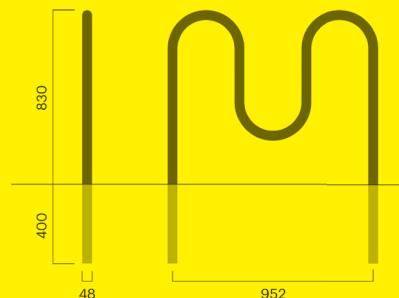

## Sinus sykkelstativ

For 7 sykler

Forankring A eller C		kg CO <sub>2</sub> e	MJ	kg
Art. 383-900A	5 700 NOK	88	1 195	24
Art. 383-901A	5 100 NOK	88	1 195	24
Art. 383-900C	5 100 NOK	90	1 219	20
Art. 383-901C	4 200 NOK	90	1 219	20

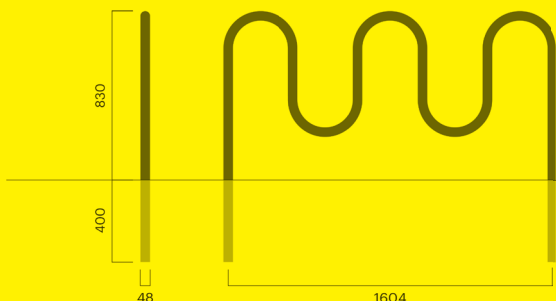

## Sinus sykkelstativ

For 9 sykler

Forankring A eller C		kg CO <sub>2</sub> e	MJ	kg
Art. 385-900A	6 800 NOK	114	1 553	31
Art. 385-901A	5 600 NOK	114	1 553	31
Art. 385-900C	6 100 NOK	116	1 572	25
Art. 385-901C	5 000 NOK	116	1 572	25

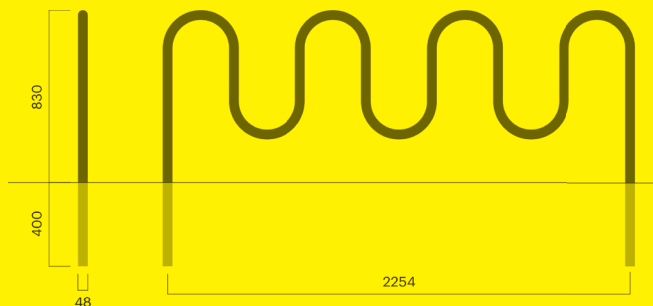





## Stones module #1

		kg CO <sub>2</sub> e	MJ	kg
<b>Benk H450</b>				
Art. 5202-900	37 000 NOK	315	4 971	112
Art. 5202-901	29 900 NOK	315	4 971	112
<b>Benk H600</b>				
Art. 5204-900	38 700 NOK	347	5 164	125
Art. 5204-901	31 600 NOK	347	5 164	125
<b>Plantekasse H400, 320 liter</b>				
Art. 5280-900	28 600 NOK	373	5 197	122
Art. 5280-901	21 300 NOK	373	5 197	122
<b>Plantekasse H550, 500 liter</b>				
Art. 5282-900	29 900 NOK	373	5 197	136
Art. 5282-901	23 100 NOK	373	5 197	136

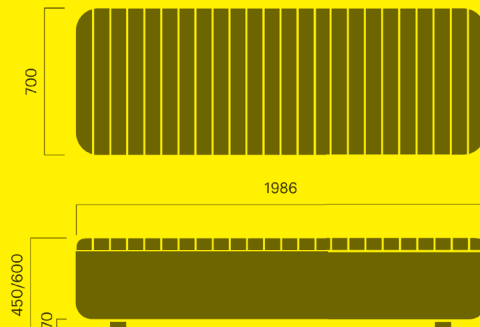

## Stones module #2

		kg CO <sub>2</sub> e	MJ	kg
<b>Benk H450</b>				
Art. 5206-900	32 700 NOK	261	3 951	98
Art. 5206-901	26 300 NOK	261	3 951	98
<b>Benk H600</b>				
Art. 5208-900	35 200 NOK	314	4 685	115
Art. 5208-901	28 000 NOK	314	4 685	115
<b>Plantekasse H400, 320 liter</b>				
Art. 5284-900	26 500 NOK	326	4 545	109
Art. 5284-901	20 100 NOK	326	4 545	109
<b>Plantekasse H550, 500 liter</b>				
Art. 5286-900	29 500 NOK	375	5 220	126
Art. 5286-901	22 000 NOK	375	5 220	126

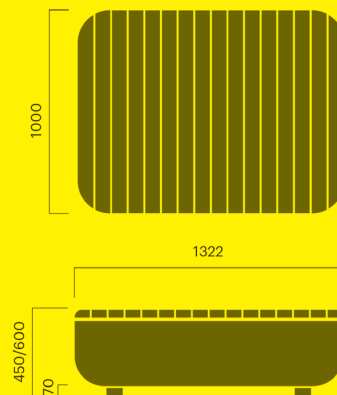

## Stones modul #3

		kg CO <sub>2</sub> e	MJ	kg
<b>Benk H450</b>				
Art. 5210-900	39 400 NOK	348	5 352	135
Art. 5210-901	32 000 NOK	348	5 352	135
<b>Benk H600</b>				
Art. 5212-900	41 200 NOK	415	6 290	157
Art. 5212-901	34 100 NOK	415	6 290	157
<b>Plantekasse H400, 320 liter</b>				
Art. 5288-900	30 900 NOK	460	6 412	156
Art. 5288-901	24 400 NOK	460	6 412	156
<b>Plantekasse H550, 500 liter</b>				
Art. 5290-900	33 000 NOK	524	7 294	177
Art. 5290-901	26 300 NOK	524	7 294	177

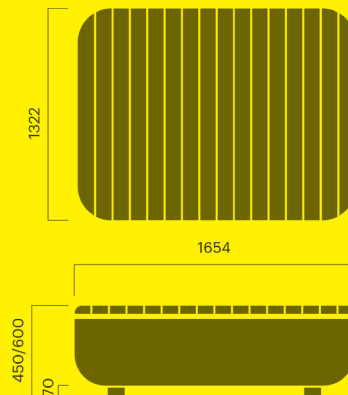

# Stoop



## Stoop mini

		kg CO <sub>2</sub> e	MJ	kg
Art. 2413-900	<b>31 900 NOK</b>	507	7 275	141
Art. 2413-901	<b>27 000 NOK</b>	507	7 275	141

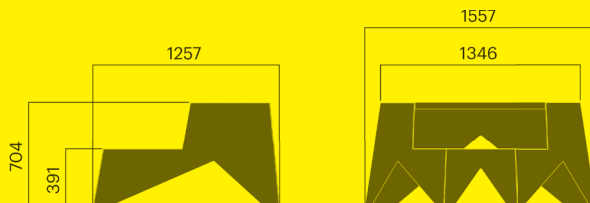

## Stoop bank

		kg CO <sub>2</sub> e	MJ	kg
Art. 2417-900	<b>45 000 NOK</b>	615	9 168	226
Art. 2417-901	<b>37 000 NOK</b>	615	9 168	226

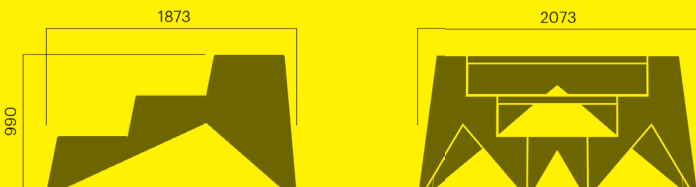

## Stoop benkebord

		kg CO <sub>2</sub> e	MJ	kg
Art. 2422-900	<b>35 000 NOK</b>	442	6 898	207
Art. 2422-901	<b>31 600 NOK</b>	442	6 898	207

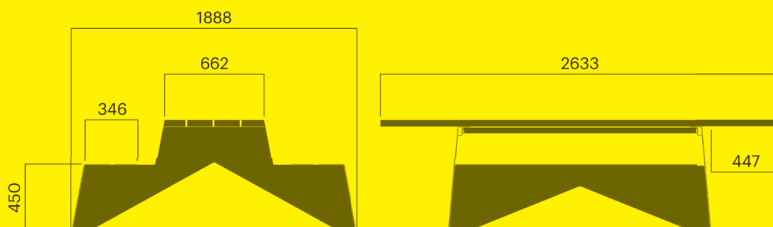



## Stripes benk rektangulær

		kg CO <sub>2</sub> e	MJ	kg
Art. 3606-900	<b>22 900 NOK</b>	151	2 713	80
Art. 3606-901	<b>21 200 NOK</b>	151	2 713	79

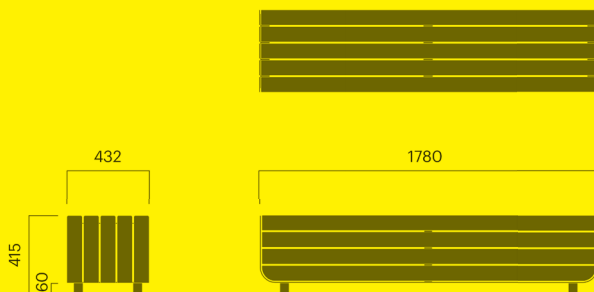

## Stripes benk start- og endemodul

		kg CO <sub>2</sub> e	MJ	kg
Art. 3607-900	<b>19 500 NOK</b>	142	2 413	68
Art. 3607-901	<b>17 300 NOK</b>	142	2 413	68

### Påbyggingsmodul

Art. 3608-900	<b>15 600 NOK</b>	136	2 165	56
Art. 3608-901	<b>13 300 NOK</b>	136	2 165	56

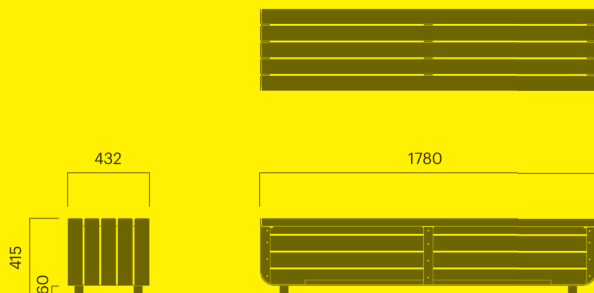

## Stripes benk start- og endemodul

Start og ende		kg CO <sub>2</sub> e	MJ	kg
Art. 3607-900V	<b>25 300 NOK</b>	180	2 932	74
Art. 3607-901V	<b>23 300 NOK</b>	180	2 932	75
Art. 3607-900M	<b>25 300 NOK</b>	177	2 885	73
Art. 3607-901M	<b>23 300 NOK</b>	177	2 885	77
Art. 3607-900H	<b>25 300 NOK</b>	180	2 932	74
Art. 3607-901H	<b>23 300 NOK</b>	180	2 932	74

### Påbyggingsmodul

Art. 3608-900V	<b>22 600 NOK</b>	172	2 612	63
Art. 3608-901V	<b>20 500 NOK</b>	172	2 612	63
Art. 3608-900M	<b>22 600 NOK</b>	166	2 528	61
Art. 3608-901M	<b>20 500 NOK</b>	166	2 528	60
Art. 3608-900H	<b>22 600 NOK</b>	172	2 612	63
Art. 3608-901H	<b>20 500 NOK</b>	172	2 612	63

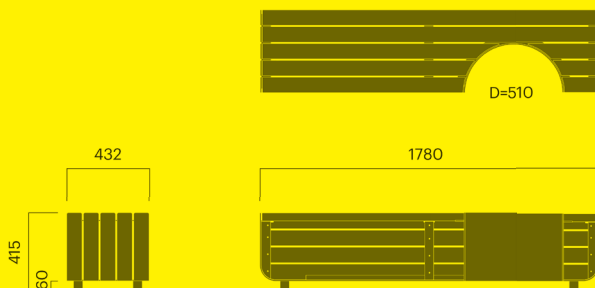

## Stripes sirkelbenk liten

		kg CO <sub>2</sub> e	MJ	kg
Art. 3612-900	<b>36 300 NOK</b>	324	4 761	108
Art. 3612-901	<b>31 900 NOK</b>	324	4 761	108

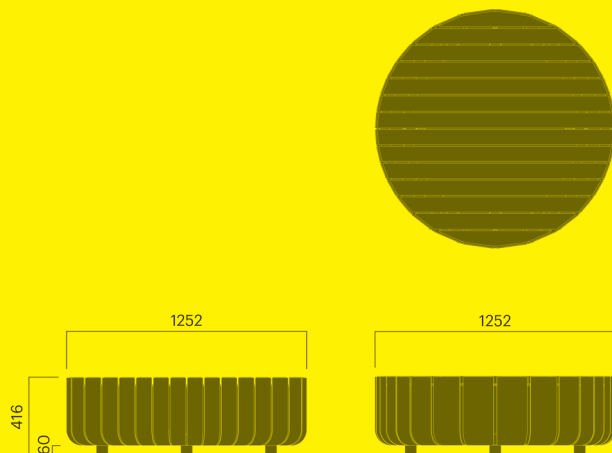

## Stripes sirkelbenk stor

		kg CO <sub>2</sub> e	MJ	kg
Art. 3610-900	<b>42 600 NOK</b>	459	7 193	184
Art. 3610-901	<b>36 900 NOK</b>	459	7 193	185

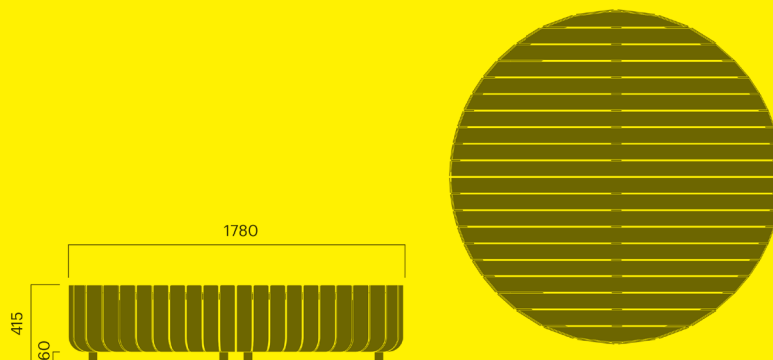

## Stripes sirkelbenk med hull for plante

Sylinderen plasseres til høyre (H), venstre (V) eller i midten (M)

		kg CO <sub>2</sub> e	MJ	kg
Art. 3611-900HV	<b>60 500 NOK</b>	537	8 284	201
Art. 3611-901HV	<b>53 300 NOK</b>	537	8 284	212
Art. 3611-900M	<b>60 500 NOK</b>	518	8 012	206
Art. 3611-901M	<b>53 300 NOK</b>	518	8 012	208

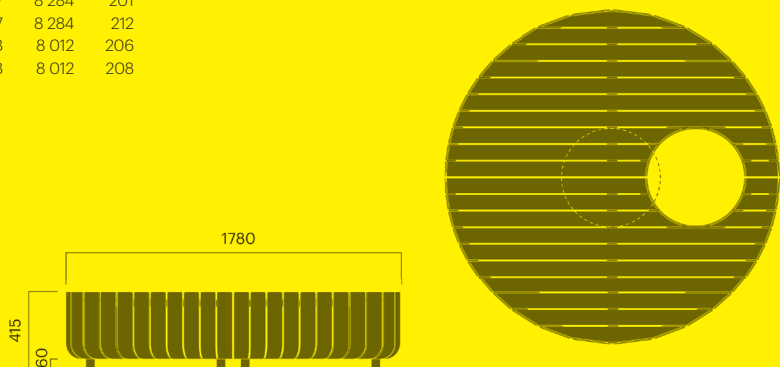

## Stripes benk halvsirkel

		kg CO <sub>2</sub> e	MJ	kg
<b>Åpen (for sammenkobling)</b>				
Art. 3616-900	<b>21 200 NOK</b>	228	3 581	92
Art. 3616-901	<b>18 500 NOK</b>	228	3 581	92
<b>Lukket</b>				
Art. 3617-900	<b>25 600 NOK</b>	236	3 858	104
Art. 3617-901	<b>23 000 NOK</b>	236	3 858	104

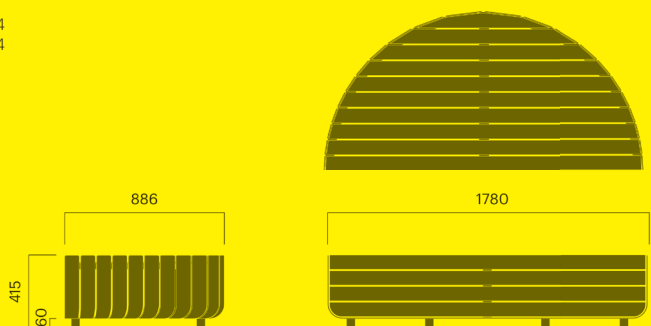

## Stripes benk åpen halvsirkel

		kg CO <sub>2</sub> e	MJ	kg
Art. 3616-900V	<b>30 300 NOK</b>	269	4 142	106
Art. 3616-901V	<b>26 600 NOK</b>	269	4 142	95
Art. 3616-900M	<b>30 300 NOK</b>	261	4 058	95
Art. 3616-901M	<b>26 600 NOK</b>	261	4 058	95
Art. 3616-900H	<b>30 300 NOK</b>	269	4 142	95
Art. 3616-901H	<b>26 600 NOK</b>	269	4 142	95

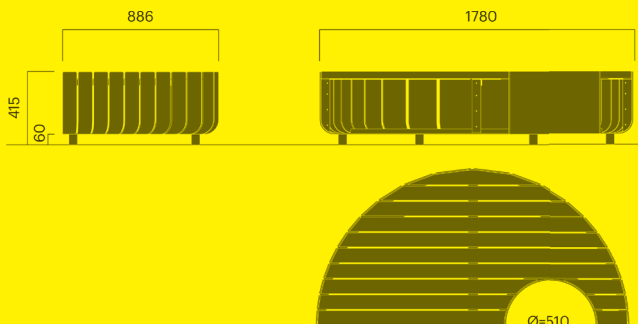

## Stripes plantekasse liten

170 liter

		kg CO <sub>2</sub> e	MJ	kg
<b>Lav</b>				
Art. 3678-900	31 900 NOK	478	6 665	151
Art. 3678-901	26 500 NOK	478	6 665	151

440 liter

		kg CO <sub>2</sub> e	MJ	kg
<b>Høy</b>				
Art. 3674-900	42 600 NOK	734	10 230	233
Art. 3674-901	37 200 NOK	734	0	232

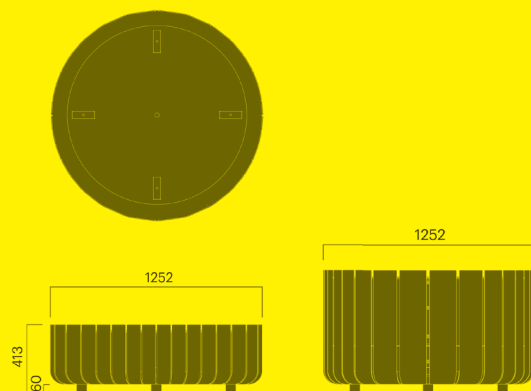

## Stripes plantekasse stor

450 liter

		kg CO <sub>2</sub> e	MJ	kg
Art. 3684-900	50 800 NOK	894	12 457	281
Art. 3684-901	45 500 NOK	894	12 457	281

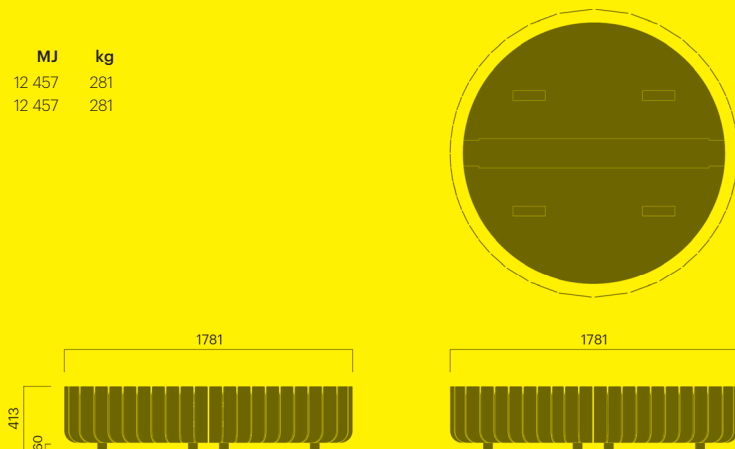

## Stripes plantekasse halvsirkel

225 liter

		kg CO <sub>2</sub> e	MJ	kg
<b>Lav</b>				
Art. 3683-900	31 900 NOK	515	6 665	160
Art. 3683-901	26 500 NOK	515	6 665	160

**Åpen (for sammenkobling)**

Art. 3682-900	25 500 NOK	454	6 324	143
Art. 3682-901	22 700 NOK	454	6 324	143

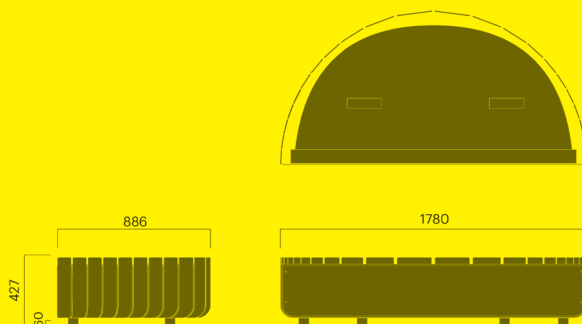

# Tour



## Tour sykkelstativ

For 2 sykler

Forankring A eller C		kg CO <sub>2</sub> e	MJ	kg
Art. 2886-900A	4 200 NOK	75	1 046	24
Art. 2886-901A	3 400 NOK	75	1 046	24
Art. 2886-900C	4 100 NOK	92	1 276	29
Art. 2886-901C	3 300 NOK	92	1 276	29

Andre utskjæringer på forespørsel.

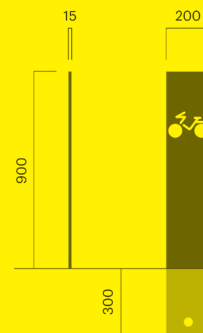

# Urban



## Urban krakk

Smal krakk, forankring A eller C		kg CO <sub>2</sub> e	MJ	kg
Art. 503-900A	8 500 NOK	69	1 192	35
Art. 503-901A	7 500 NOK	69	1 192	35
Art. 503-900C	8 500 NOK	76	1 286	35
Art. 503-901C	7 500 NOK	76	1 286	35

### Bred krakk, forankring A eller C

Art. 504-900A	9 400 NOK	73	1 306	40
Art. 504-901A	8 700 NOK	73	1 306	40
Art. 504-900C	9 400 NOK	81	1 409	40
Art. 504-901C	8 700 NOK	81	1 409	40

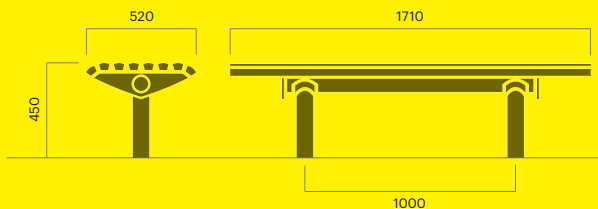

## Urban krakk

Smal krakk, frittstående		kg CO <sub>2</sub> e	MJ	kg
Art. 506-900	9 500 NOK	80	1 347	36
Art. 506-901	8 100 NOK	80	1 347	36

Bred krakk, frittstående		kg CO <sub>2</sub> e	MJ	kg
Art. 507-900	10 600 NOK	85	1 475	40
Art. 507-901	9 200 NOK	85	1 475	40

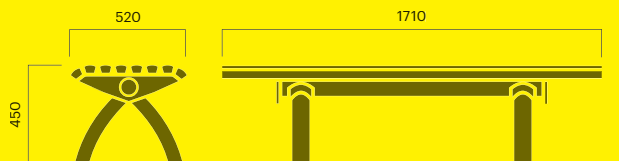

## Urban krakk

Smal krakk, med granittsokkel		kg CO <sub>2</sub> e	MJ	kg
Art. 508-900	15 900 NOK	87	1 945	100
Art. 508-901	14 400 NOK	87	1 945	100

  

Bred krakk, med granittsokkel		kg CO <sub>2</sub> e	MJ	kg
Art. 509-900	17 000 NOK	92	2 074	104
Art. 509-901	15 500 NOK	92	2 074	104



## Urban armlene for krakk

Armlenesett		kg CO <sub>2</sub> e	MJ	kg
Art. 526-900	2 700 NOK	17	236	4
Art. 526-901	2 000 NOK	17	236	4

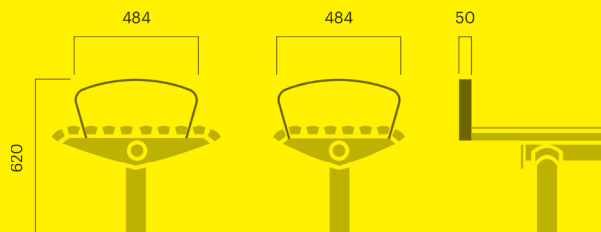



## Urban benk

Forankring A, B eller C		kg CO <sub>2</sub> e	MJ	kg
Art. 513-900A	10 800 NOK	82	1 508	44
Art. 513-901A	9 400 NOK	82	1 508	44
Art. 513-900B	10 800 NOK	82	1 508	44
Art. 513-901B	9 400 NOK	82	1 508	44
Art. 513-900C	10 800 NOK	87	1 424	47
Art. 513-901C	9 400 NOK	87	1 424	46

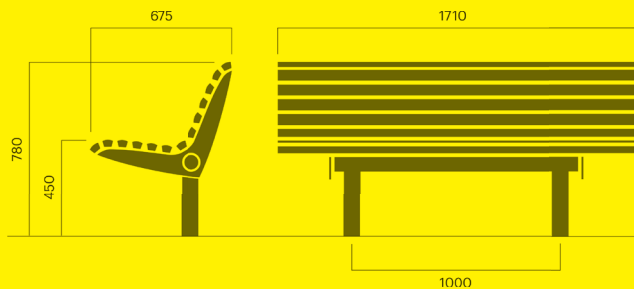

## Urban benk

Frittstående		kg CO <sub>2</sub> e	MJ	kg
Art. 516-900	13 800 NOK	90	1 625	47
Art. 516-901	12 500 NOK	90	1 625	47

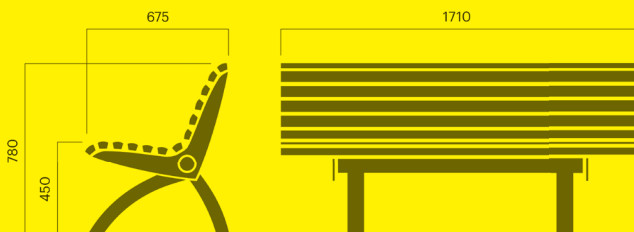

## Urban benk

Med granitt sokkel		kg CO <sub>2</sub> e	MJ	kg
Art. 518-900	19 800 NOK	84	1 601	101
Art. 518-901	18 700 NOK	84	1 601	101

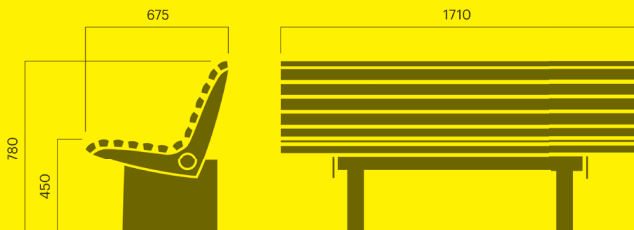

## Urban armlene for benk

Armlenesett		kg CO <sub>2</sub> e	MJ	kg
Art. 525-900	2 800 NOK	19	259	6
Art. 525-901	2 400 NOK	19	259	6

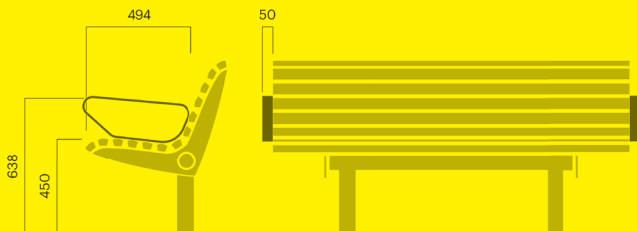

## Urban solbenk

Frittstående / for fastbolting		kg CO <sub>2</sub> e	MJ	kg
Art. 566-900	19 800 NOK	167	2 658	87
Art. 566-901	16 900 NOK	167	2 658	79

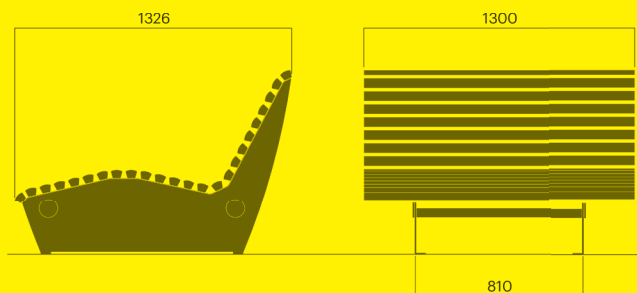

## Urban bord

Forankring A eller C		kg CO <sub>2</sub> e	MJ	kg
Art. 533-900A	9 800 NOK	97	1 656	48
Art. 533-901A	8 500 NOK	97	1 656	48
Art. 533-900C	9 800 NOK	96	1 627	45
Art. 533-901C	8 500 NOK	96	1 627	45

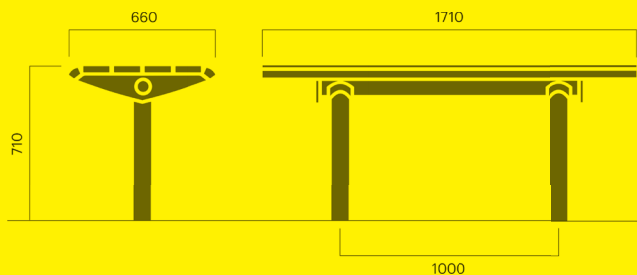

## Urban bord

Frittstående		kg CO <sub>2</sub> e	MJ	kg
Art. 536-900	11 800 NOK	86	1 498	48
Art. 536-901	10 600 NOK	86	1 498	41

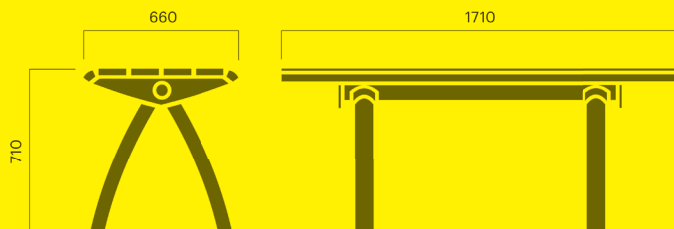

## Urban bord

Forankring A eller C		kg CO <sub>2</sub> e	MJ	kg
Art. 539-900A	11 400 NOK	102	1 772	48
Art. 539-901A	9 800 NOK	102	1 772	49
Art. 539-900C	11 400 NOK	97	1 711	49
Art. 539-901C	9 800 NOK	97	1 711	49

Frittstående		kg CO <sub>2</sub> e	MJ	kg
Art. 539-900	13 100 NOK	102	1 722	48
Art. 539-901	11 700 NOK	102	1 722	48

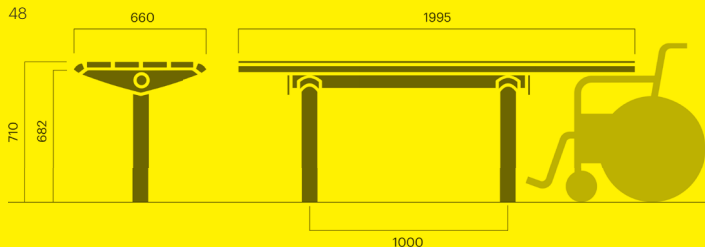

## Urban avfallsbeholder

25 liter

For vegg og monteringsstativ		kg CO <sub>2</sub> e	MJ	kg
Art. 541-900	6 500 NOK	38	535	12
Art. 541-901	5 800 NOK	38	535	12

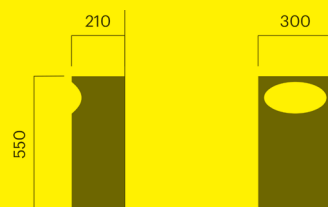

## Urban avfallsbeholder

100 liter

For oppheng på vegg		kg CO <sub>2</sub> e	MJ	kg
Art. 546-900	12 400 NOK	120	1 680	45
Art. 546-901	10 400 NOK	120	1 680	38

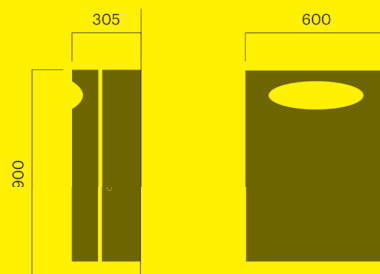

## Urban avfallsbeholder

100 liter

		kg CO <sub>2</sub> e	MJ	kg
Art. 542-900	14 600 NOK	154	2 240	63
Art. 542-901	12 600 NOK	154	2 240	62

### Med askebeuger

Art. 543-900	17 800 NOK	160	2 368	63
Art. 543-901	15 800 NOK	160	2 368	81

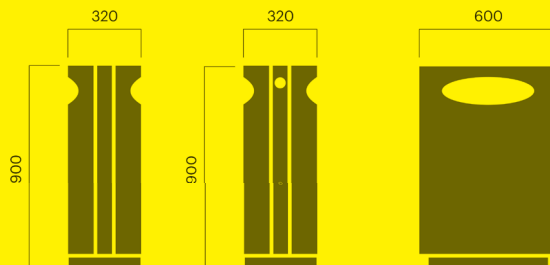

## Urban avfallsbeholder

140 liter

		kg CO <sub>2</sub> e	MJ	kg
Art. 544-900	15 600 NOK	183	2 712	81
Art. 544-901	13 600 NOK	183	2 712	81

### Med askebeuger

Art. 545-900	17 800 NOK	194	2 926	75
Art. 545-901	15 800 NOK	194	2 926	83

### Kildesortering 2 x 70 liter

Art. 547-900	19 500 NOK	209	3 067	88
Art. 547-901	15 700 NOK	209	3 067	83

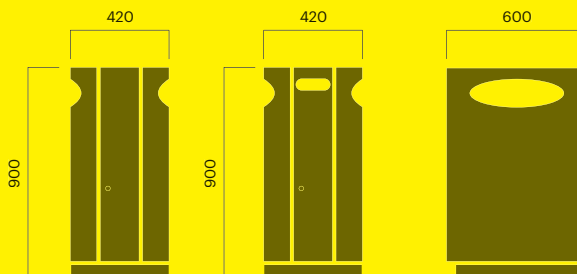

## Urban rustfri kappe

For betongsokkel 100 liter	kg CO <sub>2</sub> e	MJ	kg
Art. 542-002	1 200 NOK	8	138
			2

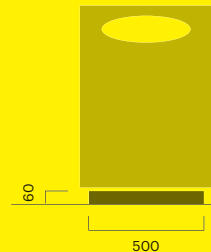

## Urban avfallsbeholder

200 liter

		kg CO <sub>2</sub> e	MJ	kg
Art. 548-900	22 500 NOK	248	3 694	112
Art. 548-901	19 500 NOK	248	3 694	114

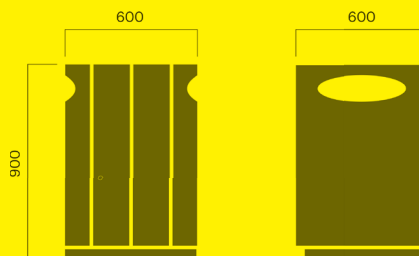

## Urban kildesortering

3 x 80 liter

		kg CO <sub>2</sub> e	MJ	kg
Art. 572-900	29 800 NOK	280	3 913	89
Art. 572-901	26 800 NOK	280	3 913	85

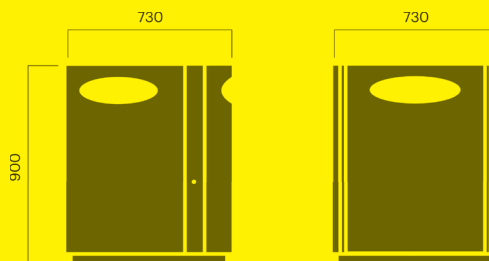

## Urban monteringsstativ

Forankring A eller C		kg CO <sub>2</sub> e	MJ	kg
Art. 592-900A	2 500 NOK	54	746	18
Art. 592-901A	2 200 NOK	54	746	18
Art. 593-900C	3 000 NOK	74	746	25
Art. 593-901C	2 400 NOK	54	746	25

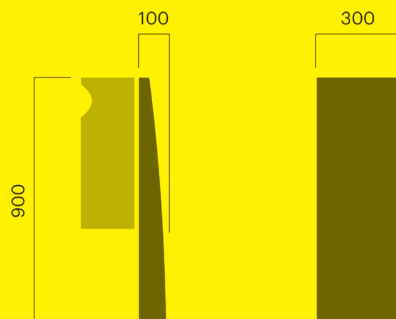

## Urban askebeger

7 liter		kg CO <sub>2</sub> e	MJ	kg
<b>For oppheng på vegg</b>				
Art. 560-900	5 800 NOK	37	513	8
Art. 560-901	4 800 NOK	37	513	8

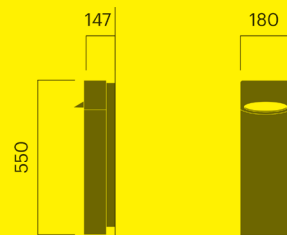

## Urban rustfri kappe

For betongsokkel 140 liter		kg CO <sub>2</sub> e	MJ	kg
Art. 544-002	1 300 NOK	8	138	2

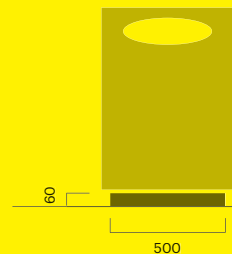

## Urban sykkelpullert

For 2 sykler

Forankring A eller C		kg CO <sub>2</sub> e	MJ	kg
Art. 586-900A	2 600 NOK	34	470	11
Art. 586-901A	2 300 NOK	34	470	11
Art. 586-900C	2 300 NOK	31	437	10
Art. 586-901C	2 000 NOK	31	437	10
<b>Med LED-belysning</b>				
Art. 586-900A-LED	7 000 NOK	36	496	11
Art. 586-901A-LED	6 300 NOK	36	496	11
Art. 586-900C-LED	6 700 NOK	34	468	11
Art. 586-901C-LED	6 000 NOK	34	468	11
<b>Demonterbar</b>				
Art. 586-900D	6 300 NOK	46	646	11
Art. 586-901D	5 800 NOK	46	646	14

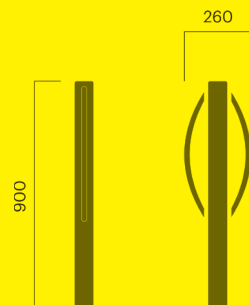

## Urban stammevern

Med fotplante		kg CO <sub>2</sub> e	MJ	kg
Art. 558-900	10 500 NOK	148	2 065	47
Art. 558-901	9 000 NOK	148	2 065	47
<b>Nedgravingsfeste sett</b>				
Art. 559-901	2 600 NOK	22	314	7

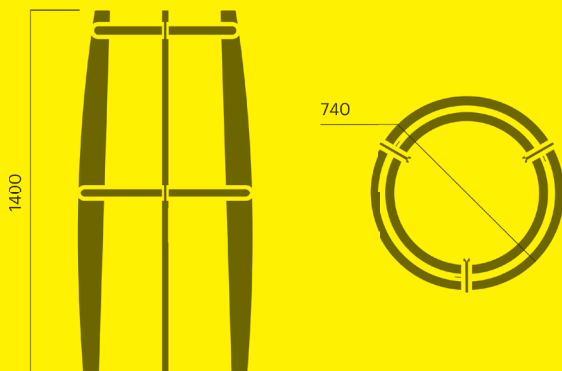

## Urban markrist

1200 x 1200		kg CO <sub>2</sub> e	MJ	kg
Art. 565-900	12 600 NOK	272	3 800	88
Art. 565-901	10 300 NOK	272	3 800	86
<b>D 1380</b>				
Art. 565-900R	12 600 NOK	260	3 623	82
Art. 565-901R	10 300 NOK	260	3 623	95

Andre mønster og størrelser på forespørsel.

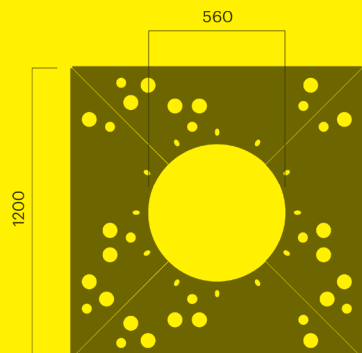

## Urban pullert D 76

Forankring A eller C		kg CO <sub>2</sub> e	MJ	kg
Art. 585-900A	1 900 NOK	27	371	9
Art. 585-901A	1 700 NOK	27	371	9
Art. 585-900C	1 700 NOK	22	305	7
Art. 585-901C	1 500 NOK	27	371	7
<b>Demonterbar</b>				
Art. 585-900D	3 000 NOK	28	395	9
Art. 585-901D	2 800 NOK	28	395	9

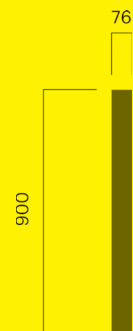

## Urban pullert D 127

Forankring A eller C		kg CO <sub>2</sub> e	MJ	kg
Art. 588-900A	3 600 NOK	60	831	19
Art. 588-901A	3 400 NOK	60	831	14
Art. 588-900C	3 500 NOK	54	747	17
Art. 588-901C	3 100 NOK	54	747	17
<b>Demonterbar</b>				
Art. 588-900D	4 600 NOK	60	838	19
Art. 588-901D	4 100 NOK	60	838	19

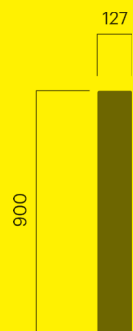

## Urban pullert

Med feste for kjetting eller tau

Forankring A eller C		kg CO <sub>2</sub> e	MJ	kg
Art. 584-900A	2 900 NOK	27	376	9
Art. 584-901A	2 700 NOK	27	376	10
Art. 584-900C	2 800 NOK	29	400	9
Art. 584-901C	2 600 NOK	29	400	9
<b>Demonterbar</b>				
Art. 584-900D	3 100 NOK	30	422	9
Art. 584-901D	2 900 NOK	30	422	10

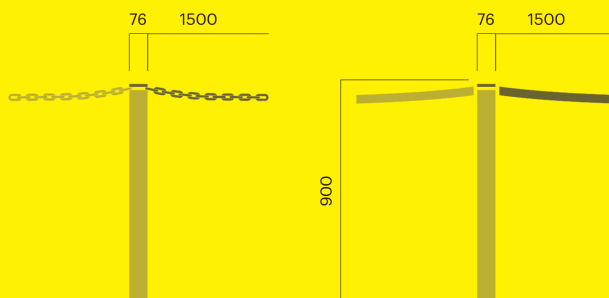



## Urban pullert

Kjetting 1 meter		kg CO <sub>2</sub> e	MJ	kg
Art. 590-900	600 NOK	6	88	0
Art. 590-901	300 NOK	6	88	2
<b>Hamptau 1,5 meter</b>				
Art. 582-900	2 200 NOK	9	186	2
Art. 582-901	2 100 NOK	9	186	4
<b>Fuglestopper for Urban avfalls- beholder</b>				
Art. 574-902	2 900 NOK	4	67	2

## Vega



### Forankringsmuligheter

For 2 sykler

Lakkert aluminium		kg CO <sub>2</sub> e	MJ	kg
Art. 3996-904C	5 200 NOK	247	2 502	11

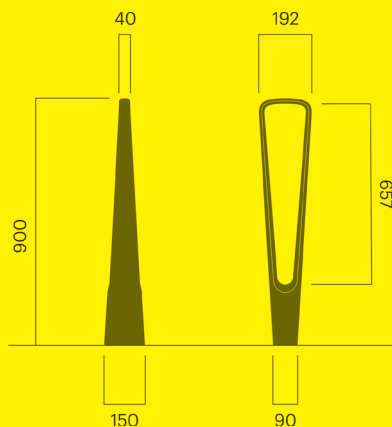

## Vestre Habitats



A

C

## Leaf insektshotell

Forankring A eller C		kg CO <sub>2</sub> e	MJ	kg
Art. 5903-900A	4 200 NOK	40	558	13
Art. 5903-901A	3 100 NOK	40	558	16
Art. 5903-900C	3 900 NOK	41	577	13
Art. 5903-901C	2 800 NOK	41	577	16

### Ulike fronter og innmat (x2), Perføret front og bakside

Art. 5904-900	3 900 NOK	7	103	3
Art. 5904-901	2 500 NOK	7	103	3

### Trefront og bakside

Art. 5906-811	2 900 NOK	1	23	2
---------------	-----------	---	----	---

### Humblebo av tre

Art. 5907-811	2 900 NOK	1	23	0
---------------	-----------	---	----	---

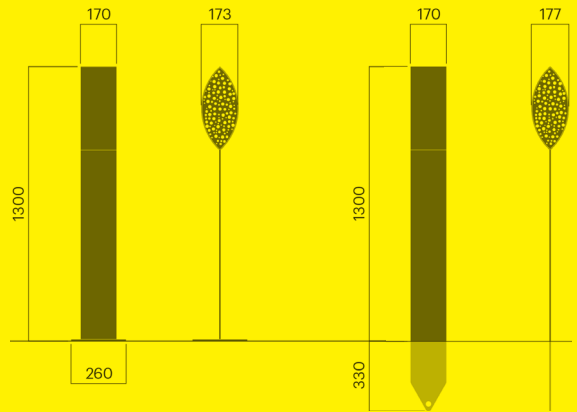

## Leaf insektshotell dobbel

Forankring A eller C		kg CO <sub>2</sub> e	MJ	kg
Art. 5905-900A	6 200 NOK	62	864	20
Art. 5905-901A	5 100 NOK	62	864	20
Art. 5905-900C	6 800 NOK	80	1 119	26
Art. 5905-901C	5 800 NOK	80	1 119	26

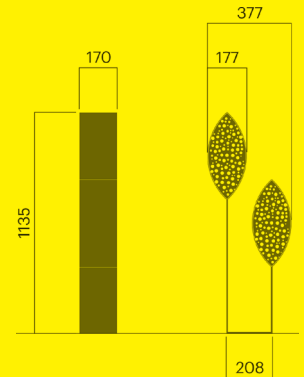

## Wings

Kombinasjon med 3 kasser i ulike størrelser og integrert insektshotell

		kg CO <sub>2</sub> e	MJ	kg
Art. 5823-900C	32 000 NOK	140	2 166	46
Art. 5823-901C	31 000 NOK	140	2 166	46

### Bred fuglekasse

Art. 5824-904	9 200 NOK	46	771	11
---------------	-----------	----	-----	----

### Høy fuglekasse

Art. 5825-904	9 900 NOK	23	374	10
---------------	-----------	----	-----	----

### Fugle- og insektskasse

Art. 5826-904	9 900 NOK	23	381	7
---------------	-----------	----	-----	---

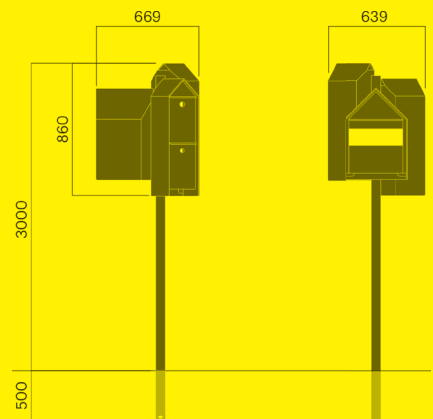

## Wings

### 2 m monteringsstolpe

		kg CO <sub>2</sub> e	MJ	kg
Art. 5827-900A	<b>2 800 NOK</b>	188	2 612	11
Art. 5827-901A	<b>2 100 NOK</b>	188	2 612	13
Art. 5827-900C	<b>2 600 NOK</b>	42	589	13
Art. 5827-901C	<b>1 900 NOK</b>	42	589	13

### 3 m monteringsstolpe forankring A eller C

Art. 5828-900A	<b>3 100 NOK</b>	204	2 838	16
Art. 5828-901A	<b>2 500 NOK</b>	204	2 838	18
Art. 5828-900C	<b>2 900 NOK</b>	59	831	18
Art. 5828-901C	<b>2 200 NOK</b>	59	831	18

### Stor fotplate/fot D700mm for 2 m stolpe

Art. 5829-900	<b>5 100 NOK</b>	151	2 109	48
Art. 5829-901	<b>4 400 NOK</b>	151	2 109	48



## Decay Edge kompost- og plantekasse

### Kvadrat H400

		kg CO <sub>2</sub> e	MJ	kg
Art. 5880-900	<b>19 800 NOK</b>	246	3 432	117
Art. 5880-901	<b>18 400 NOK</b>	246	3 432	117
Art. 5880-903	<b>19 800 NOK</b>	246	3 432	117

### Kvadrat H1000

Art. 5884-900	<b>38 400 NOK</b>	615	8 580	280
Art. 5884-901	<b>33 000 NOK</b>	615	8 580	280
Art. 5884-903	<b>38 400 NOK</b>	615	8 580	280

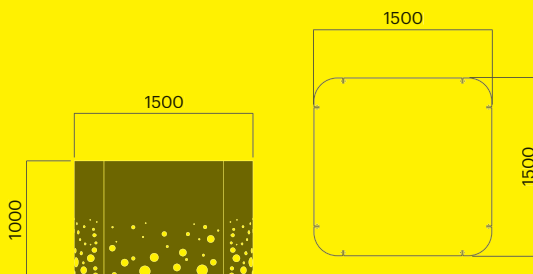

## Decay Edge kompost- og plantekasse

### Sirkel

		kg CO <sub>2</sub> e	MJ	kg
Art. 5874-900	<b>23 300 NOK</b>	571	7 958	187
Art. 5874-901	<b>19 000 NOK</b>	571	7 958	187
Art. 5874-903	<b>23 300 NOK</b>	573	3 870	187

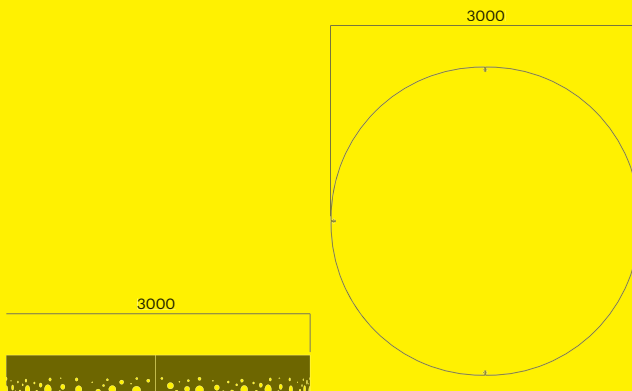

## Decay Edge moduler

### H400

		kg CO <sub>2</sub> e	MJ	kg
<b>Rett side L1000</b>				
Art. 5850-900	3 400 NOK	62	861	20
Art. 5850-901	2 900 NOK	62	861	20
<b>Rett side L2000</b>				
Art. 5852-900	6 000 NOK	95	1 371	37
Art. 5852-901	4 900 NOK	95	1 371	37
<b>Liten 900 bue/hjørne R200</b>				
Art. 5854-900	2 000 NOK	28	388	514
Art. 5854-901	1 700 NOK	28	388	514
<b>Stor 900 bue/hjørne R1470</b>				
Art. 5858-900	6 200 NOK	143	1 995	0
Art. 5858-901	5 100 NOK	143	1 995	46

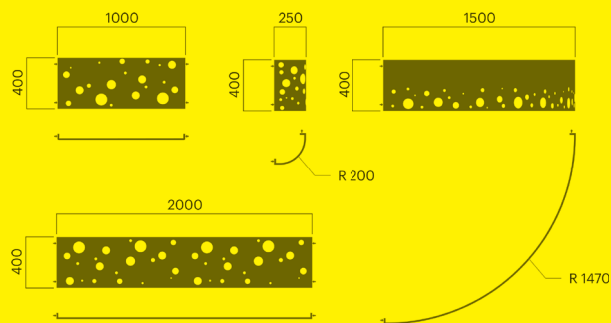

## Decay Edge moduler

### H1000

		kg CO <sub>2</sub> e	MJ	kg
<b>Rett side L1000</b>				
Art. 5860-900	6 300 NOK	162	2 255	52
Art. 5860-901	5 200 NOK	162	2 255	52
<b>Rett side L2000</b>				
Art. 5862-900	12 300 NOK	310	4 322	0
Art. 5862-901	10 200 NOK	310	4 322	101
<b>Liten 900 bue/hjørne R200</b>				
Art. 5864-900	3 700 NOK	74	1 028	24
Art. 5864-901	3 000 NOK	74	1 028	24
<b>Stor 900 bue/hjørne R1470</b>				
Art. 5868-900	14 800 NOK	370	5 156	0
Art. 5868-901	12 600 NOK	370	5 156	120

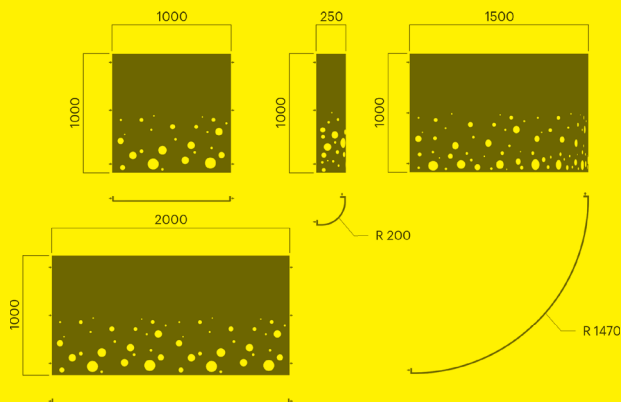

## Log benk for trestammer

### Forankring A eller C

		kg CO <sub>2</sub> e	MJ	kg
Art. 5803-900A	18 700 NOK	317	4 572	105
Art. 5803-901A	16 600 NOK	317	4 572	114
Art. 5803-900C	19 800 NOK	345	4 974	114
Art. 5803-901C	17 700 NOK	345	4 974	114

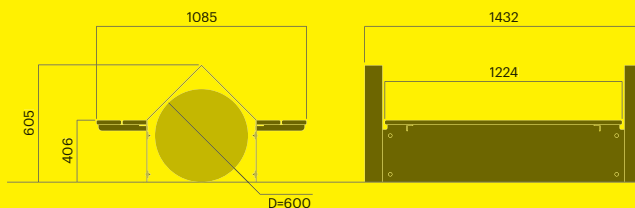

## Pile benk for steinrøys / organisk avfall

Forankring A eller C		kg CO <sub>2</sub> e	MJ	kg
Art. 5813-900A	<b>19 000 NOK</b>	237	3 453	78
Art. 5813-901A	<b>16 700 NOK</b>	237	3 453	78
Art. 5813-900C	<b>20 100 NOK</b>	251	3 652	82
Art. 5813-901C	<b>17 800 NOK</b>	251	3 652	82

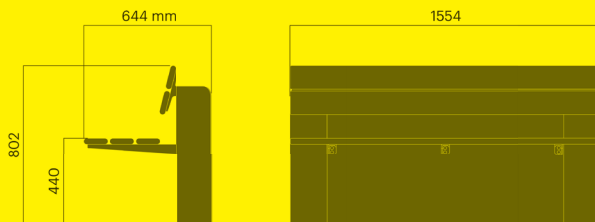

Via



## Via benk rett

Frittstående eller for vegg (B)		kg CO <sub>2</sub> e	MJ	kg
Art. 1306-900B	<b>16 900 NOK</b>	129	2 096	76
Art. 1306-901B	<b>16 300 NOK</b>	129	2 096	73
Art. 1306-900	<b>16 900 NOK</b>	101	2 475	85
Art. 1306-901	<b>15 800 NOK</b>	101	2 096	85

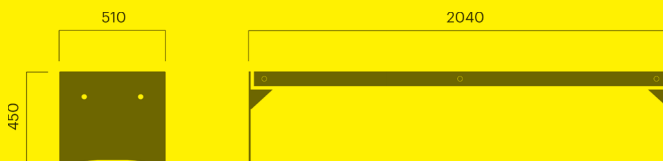

## Via benkeplate rett

		kg CO <sub>2</sub> e	MJ	kg
Art. 1320-900	<b>12 000 NOK</b>	42	1 273	48
Art. 1320-901	<b>11 600 NOK</b>	42	1 273	48
<b>For murkant</b>				
Art. 1320-900MK	<b>11 300 NOK</b>	40	1 249	47
Art. 1320-901MK	<b>11 100 NOK</b>	40	1 249	47



## Via benk buet

Frittstående eller for vegg (B)		kg CO <sub>2</sub> e	MJ	kg
Art. 1308-900	<b>25 400 NOK</b>	217	3 647	99
Art. 1308-900B	<b>26 000 NOK</b>	166		83
Art. 1308-901B	<b>23 900 NOK</b>	166		83
Art. 1308-901	<b>23 400 NOK</b>	217	3 647	99

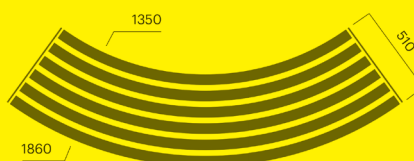
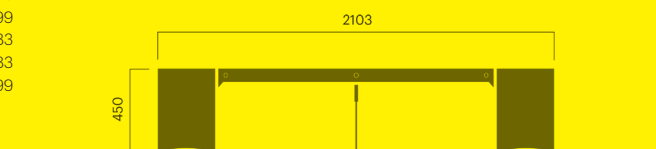

## Via sirkelbenk

		kg CO <sub>2</sub> e	MJ	kg
Art. 1310-900	<b>99 000 NOK</b>	496	10 009	404
Art. 1310-901	<b>89 000 NOK</b>	496	10 009	404

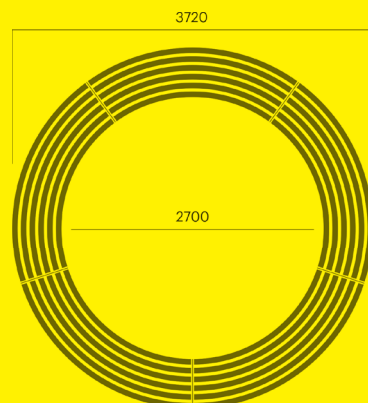

## Via benkeplate buet

		kg CO <sub>2</sub> e	MJ	kg
Art. 1330-900	20 000 NOK	99	2 001	62
Art. 1330-901	18 600 NOK	99	2 001	62
<b>For murkant</b>				
Art. 1330-900MK	16 900 NOK	64	1 549	46
Art. 1330-901MK	16 500 NOK	64	1 549	46

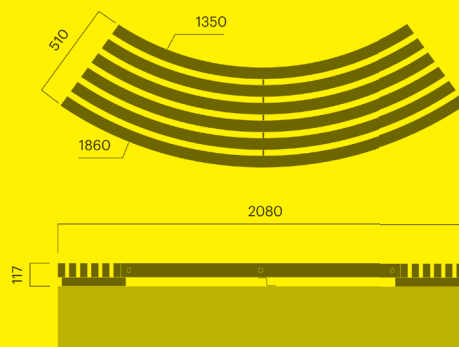

## Via kobling

Koblingselement og endestykke		kg CO <sub>2</sub> e	MJ	kg
Art. 1350-900	2 800 NOK	59	823	19
Art. 1350-901	2 600 NOK	59	823	19

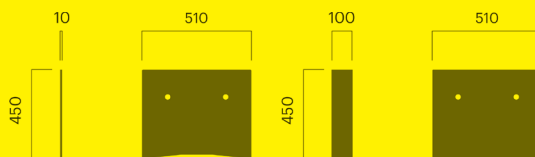

## Via dobbelkobling

		kg CO <sub>2</sub> e	MJ	kg
Art. 1352-900	4 500 NOK	136	1 888	0
Art. 1352-901	4 100 NOK	136	1 888	0

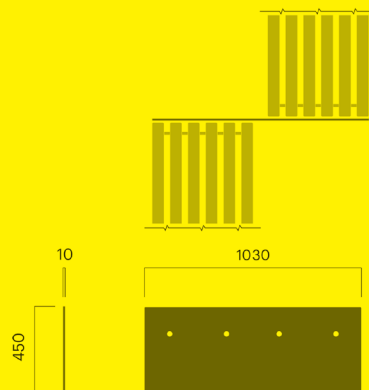

## Via

		kg CO <sub>2</sub> e	MJ	kg
<b>Armlene</b>				
Art. 1327-900	6 200 NOK	12	190	5
Art. 1327-901	5 700 NOK	12	190	5
<b>Ryggstøtte</b>				
Art. 1325-900	2 400 NOK	13	185	4
Art. 1325-901	2 000 NOK	13	185	4

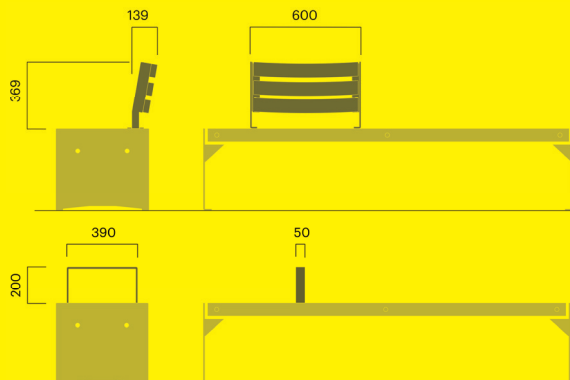

## Via bord

		kg CO <sub>2</sub> e	MJ	kg
Art. 1336-900	22 500 NOK	242	4 286	112
Art. 1336-901	20 700 NOK	242	4 286	112

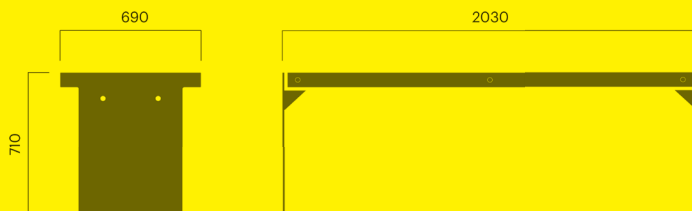

## Via bord buet

		kg CO <sub>2</sub> e	MJ	kg
Art. 1338-900	15 800 NOK	210	3 330	87
Art. 1338-901	14 600 NOK	210	3 330	87

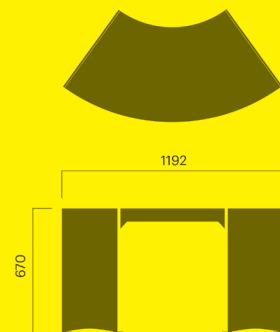



## Via plantekasse

170 liter

Lav		kg CO <sub>2</sub> e	MJ	kg
Art. 1381-900	17 000 NOK	359	4 997	114
Art. 1381-901	14 900 NOK	359	4 997	114

350 liter

Høy		kg CO <sub>2</sub> e	MJ	kg
Art. 1384-900	24 100 NOK	639	8 892	203
Art. 1384-901	21 200 NOK	639	8 892	203

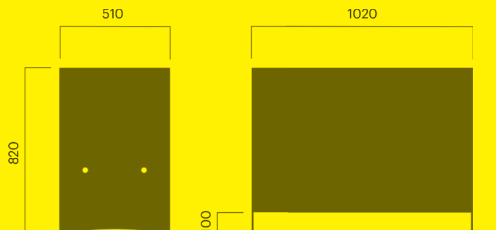

## Vroom



### Vroom krakk rett ende

		kg CO <sub>2</sub> e	MJ	kg
Art. 607-900	9 900 NOK	148	2 298	59
Art. 607-901	8 900 NOK	148	2 298	59

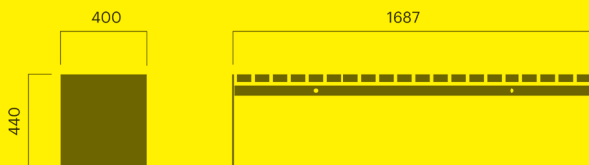

### Vroom benk rett ende

		kg CO <sub>2</sub> e	MJ	kg
Art. 617-900	15 800 NOK	190	2 892	90
Art. 617-901	14 100 NOK	190	2 892	89

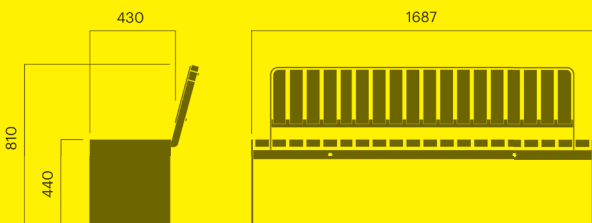

## Vroom krakk buet ende

		kg CO <sub>2</sub> e	MJ	kg
Art. 606-900	<b>12 900 NOK</b>	190	2 885	72
Art. 606-901	<b>11 400 NOK</b>	190	2 885	72

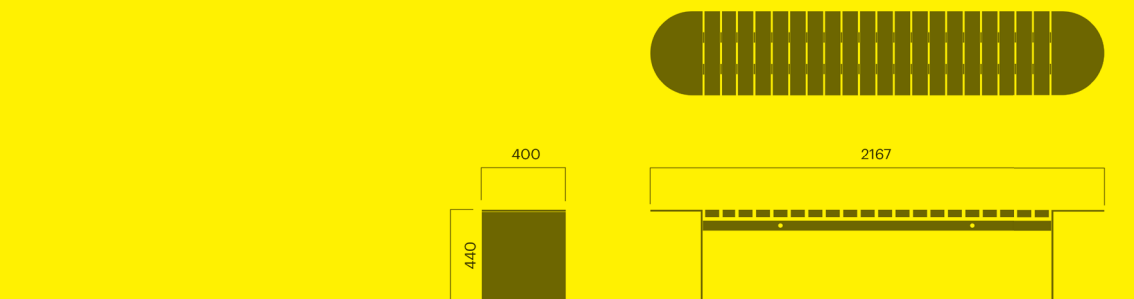

## Vroom benk buet ende

		kg CO <sub>2</sub> e	MJ	kg
Art. 616-900	<b>18 100 NOK</b>	239	3 873	103
Art. 616-901	<b>15 900 NOK</b>	239	3 873	103

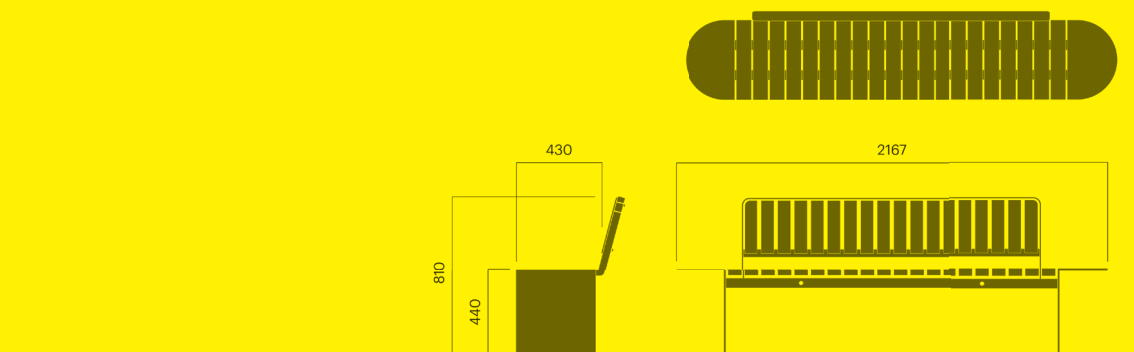

## Vroom 600 krakk

		kg CO <sub>2</sub> e	MJ	kg
Art. 609-900	<b>16 900 NOK</b>	212	3 391	89
Art. 609-901	<b>14 900 NOK</b>	212	3 391	89

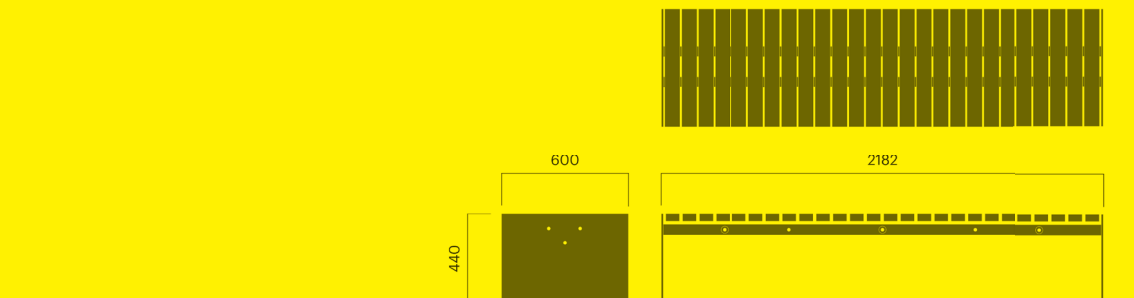

## Vroom 1200 krakk

		kg CO <sub>2</sub> e	MJ	kg
Art. 612-900	29 800 NOK	369	6 022	161
Art. 612-901	27 400 NOK	369	6 022	0

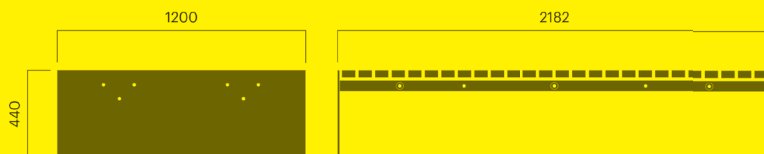
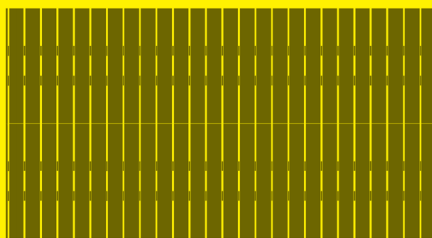

## Vroom benkeplate

Kort benkeplate		kg CO <sub>2</sub> e	MJ	kg
Art. 620-900JR	4 700 NOK	35	623	18
Art. 620-901JR	4 400 NOK	35	623	18

Standard		kg CO <sub>2</sub> e	MJ	kg
Art. 620-900	6 000 NOK	54	994	29
Art. 620-901	5 500 NOK	54	994	29

Stor benkeplate		kg CO <sub>2</sub> e	MJ	kg
Art. 632-900	10 600 NOK	73	1 457	45
Art. 632-901	9 800 NOK	73	1 457	45



## Vroom benkeplate murkant

H87 for murkant		kg CO <sub>2</sub> e	MJ	kg
Art. 620-900MK	7 400 NOK	59	1 066	31
Art. 620-901MK	7 000 NOK	59	1 066	31

H55/lavtbyggende for murkant		kg CO <sub>2</sub> e	MJ	kg
MKL1 = 988 mm, MKL2 = 1667mm, MKL3 = 1984 mm				
Art. 620-901MKL1	2 900 NOK	18	357	13
Art. 620-901MKL2	4 700 NOK	29	638	21
Art. 620-901MKL3	5 800 NOK	38	806	26



## Vroom rygg

		kg CO <sub>2</sub> e	MJ	kg
Art. 629-900	<b>6 000 NOK</b>	51	1 010	31
Art. 629-901	<b>4 700 NOK</b>	51	1 010	31

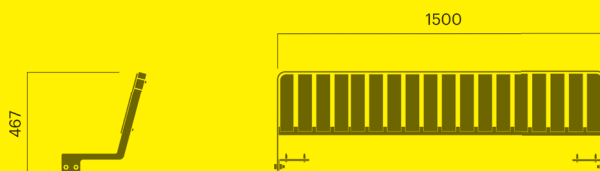

## Vroom buet benkeplate

		kg CO <sub>2</sub> e	MJ	kg
<b>D2000</b>				
Art. 630-900-D2	<b>7 300 NOK</b>	47	796	22
Art. 630-901-D2	<b>6 900 NOK</b>	47	796	22
<b>D3000</b>				
Art. 630-900-D3	<b>7 300 NOK</b>	51	853	23
Art. 630-901-D3	<b>6 900 NOK</b>	51	853	23
<b>D4000</b>				
Art. 630-900-D4	<b>7 300 NOK</b>	52	871	24
Art. 630-901-D4	<b>6 900 NOK</b>	51	853	41
<b>D5000</b>				
Art. 630-900-D5	<b>7 300 NOK</b>	54	899	25
Art. 630-901-D5	<b>6 900 NOK</b>	52	871	25
<b>For mur</b>				
Art. 630-900MK	<b>7 300 NOK</b>	54	899	19
Art. 630-901MK	<b>6 900 NOK</b>	54	899	19
Art. 630-901MKL	<b>6 900 NOK</b>	54	899	14

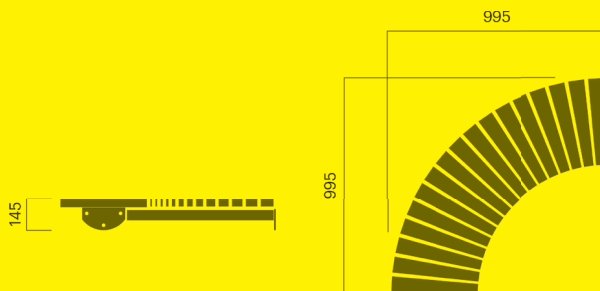

## Vroom komplett sirkelbenk

		kg CO <sub>2</sub> e	MJ	kg
<b>D2000 (4 benkeplater og ben)</b>				
Art. 610-900-D2	<b>36 000 NOK</b>	373	5 782	147
Art. 610-901-D2	<b>33 500 NOK</b>	373	5 782	147
<b>D3000 (6 benkeplater og ben)</b>				
Art. 610-900-D3	<b>58 000 NOK</b>	585	9 018	228
Art. 610-901-D3	<b>54 000 NOK</b>	585	9 018	228
<b>D4000 (8 benkeplater og ben)</b>				
Art. 610-900-D4	<b>78 000 NOK</b>	793	12 202	308
Art. 610-901-D4	<b>72 000 NOK</b>	793	12 202	444
<b>D5000 (10 benkeplater og ben)</b>				
Art. 610-900-D5	<b>99 000 NOK</b>	1003	15 511	393
Art. 610-901-D5	<b>92 000 NOK</b>	1003	15 511	393

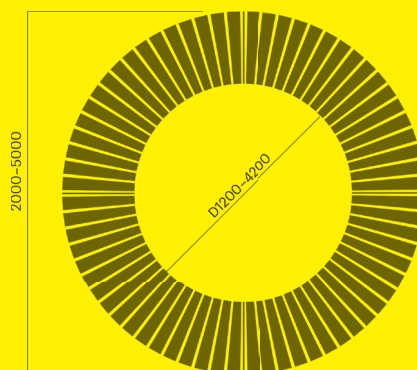

## Vroom ben/kobling

		kg CO <sub>2</sub> e	MJ	kg
Art. 650-900	<b>2 200 NOK</b>	46	641	15
Art. 650-901	<b>1 700 NOK</b>	46	641	15
Art. 650-900C	<b>2 700 NOK</b>	46	641	20
Art. 650-901C	<b>2 200 NOK</b>	46	641	20

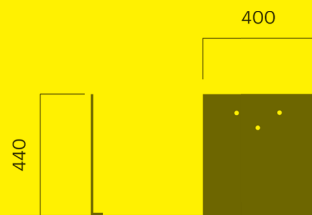

## Vroom 600 ben/kobling

		kg CO <sub>2</sub> e	MJ	kg
Art. 673-900	<b>3 100 NOK</b>	69	960	22
Art. 673-901	<b>2 700 NOK</b>	69	960	22

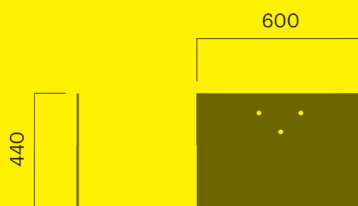

## Vroom 1200 ben/kobling

		kg CO <sub>2</sub> e	MJ	kg
Art. 675-900	<b>4 800 NOK</b>	110	1 513	35
Art. 675-901	<b>3 900 NOK</b>	110	1 513	35

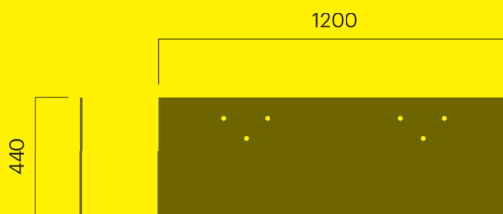

## Vroom armlene

Armlene		kg CO <sub>2</sub> e	MJ	kg
Art. 624-900	<b>1 800 NOK</b>	8	108	3
Art. 624-901	<b>1 300 NOK</b>	8	108	4
<b>For benkeplate murkant</b>				
Art. 624-900MK	<b>1 800 NOK</b>	8	108	5
Art. 624-901MK	<b>1 300 NOK</b>	8	108	5

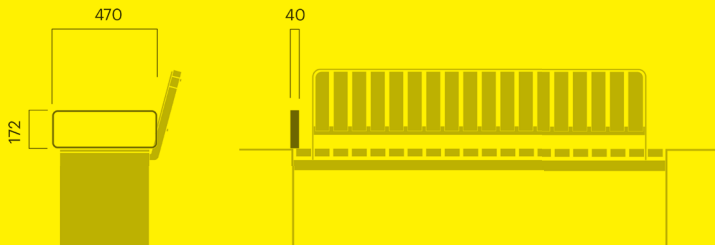

## Vroom buet ende

		kg CO <sub>2</sub> e	MJ	kg
Art. 651-900	<b>3 500 NOK</b>	68	941	21
Art. 651-901	<b>2 900 NOK</b>	68	941	21

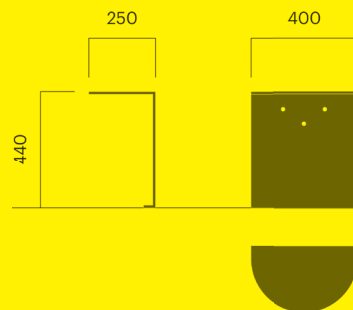

## Vroom veggfeste

Venstre		kg CO <sub>2</sub> e	MJ	kg
Art. 658-900V	<b>2 000 NOK</b>	35	489	12
Art. 658-901V	<b>1 700 NOK</b>	35	489	12
<b>Midt</b>				
Art. 658-900M	<b>2 800 NOK</b>	35	489	13
Art. 658-901M	<b>2 500 NOK</b>	35	489	12
<b>Høyre</b>				
Art. 658-900H	<b>2 000 NOK</b>	35	489	12
Art. 658-901H	<b>1 700 NOK</b>	35	489	12

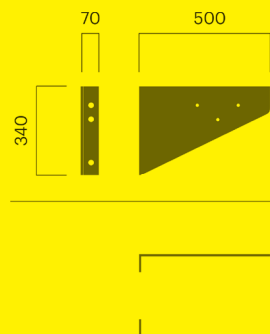

### Vroom 15° vinkel

		kg CO <sub>2</sub> e	MJ	kg
Art. 666-900	<b>6 300 NOK</b>	127	1 775	40
Art. 666-901	<b>5 200 NOK</b>	127	1 775	37

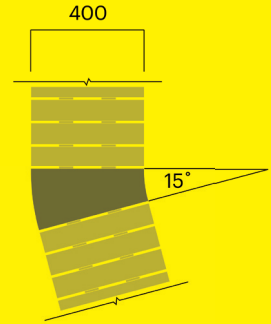

### Vroom 30° vinkel

		kg CO <sub>2</sub> e	MJ	kg
Art. 661-900	<b>6 500 NOK</b>	124	1 733	39
Art. 661-901	<b>5 700 NOK</b>	124	1 733	39

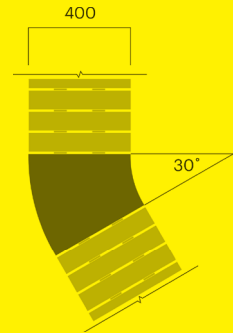

### Vroom 45° vinkel

		kg CO <sub>2</sub> e	MJ	kg
Art. 662-900	<b>6 800 NOK</b>	133	1 850	42
Art. 662-901	<b>6 200 NOK</b>	133	1 850	42

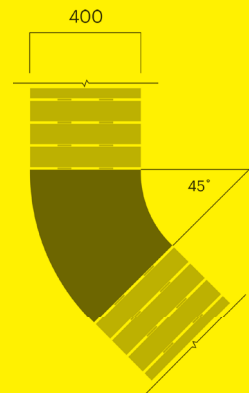

### Vroom 60° vinkel

		kg CO <sub>2</sub> e	MJ	kg
Art. 663-900	<b>7 100 NOK</b>	135	1 882	43
Art. 663-901	<b>6 300 NOK</b>	135	1 882	40

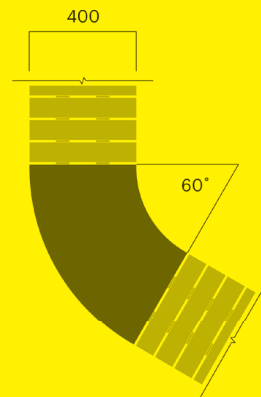

### Vroom 90° vinkel

		kg CO <sub>2</sub> e	MJ	kg
Art. 664-900	<b>7 300 NOK</b>	141	1 972	45
Art. 664-901	<b>6 500 NOK</b>	141	1 972	45

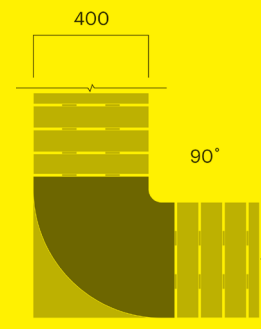

### Vroom 120° vinkel

		kg CO <sub>2</sub> e	MJ	kg
Art. 665-900	<b>7 700 NOK</b>	161	2 249	47
Art. 665-901	<b>6 800 NOK</b>	161	2 249	50

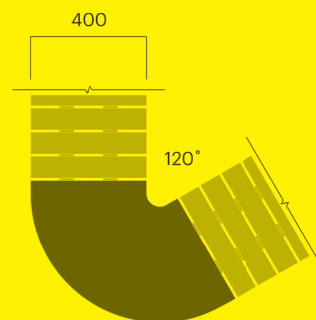



## Vroom buet rygg indre radius

Innvendig D2000		kg CO <sub>2</sub> e	MJ	kg
Art. 622-900-D2	8 000 NOK	30	465	11
Art. 622-901-D2	7 000 NOK	30	465	11
<b>IR1100</b>				
Art. 622-900-D3	8 000 NOK	33	505	22
Art. 622-901-D3	7 000 NOK	33	505	22
<b>IR1600</b>				
Art. 622-900-D4	8 000 NOK	35	548	23
Art. 622-901-D4	7 000 NOK	35	548	23
<b>IR2100</b>				
Art. 622-900-D5	8 000 NOK	37	575	25
Art. 622-901-D5	7 000 NOK	37	575	25

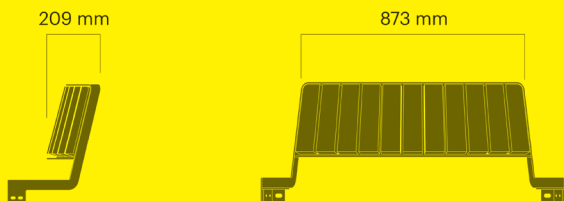

## Vroom buet rygg ytre radius

Utsiden D2000		kg CO <sub>2</sub> e	MJ	kg
Art. 623-900-D2	10 500 NOK	46	721	34
Art. 623-901-D2	9 200 NOK	46	721	34
<b>YR1500</b>				
Art. 623-900-D3	10 500 NOK	49	912	33
Art. 623-901-D3	9 200 NOK	49	912	33
<b>YR2000</b>				
Art. 623-900-D4	10 500 NOK	44	688	31
Art. 623-901-D4	9 200 NOK	44	688	31
<b>YR2500</b>				
Art. 623-900-D5	10 500 NOK	44	688	31
Art. 623-901-D5	9 200 NOK	44	688	31

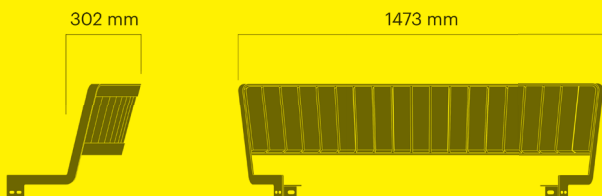

## Vroom kaffebord for benk

Benk 400		kg CO <sub>2</sub> e	MJ	kg
Art. 638-900	3 500 NOK	30	416	9
Art. 638-901	3 200 NOK	30	416	9
<b>Benk 600</b>				
Art. 639-900	3 500 NOK	32	444	0
Art. 639-901	3 200 NOK	32	444	0

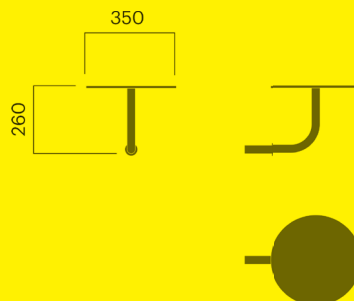

## Vroom smalt bord

		kg CO <sub>2</sub> e	MJ	kg
Art. 635-900	<b>14 300 NOK</b>	214	3 344	86
Art. 635-901	<b>12 700 NOK</b>	214	3 344	86

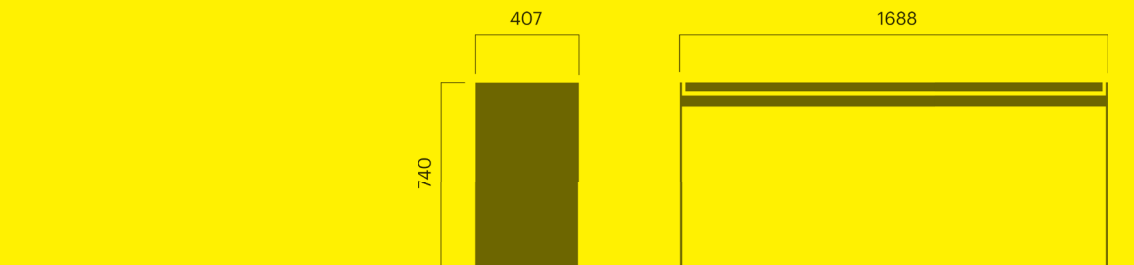

## Vroom bord

		kg CO <sub>2</sub> e	MJ	kg
Art. 636-900	<b>14 900 NOK</b>	215	3 642	101
Art. 636-901	<b>12 700 NOK</b>	215	3 642	101

### Påbyggningsmodul

Art. 640-900	<b>11 900 NOK</b>	136	2 544	0
Art. 640-901	<b>9 900 NOK</b>	136	2 544	70

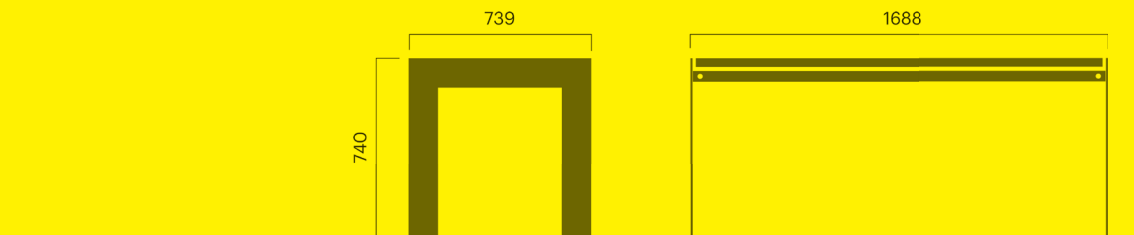

## Vroom kvadratbord

		kg CO <sub>2</sub> e	MJ	kg
Art. 637-900	<b>26 500 NOK</b>	340	5 309	137
Art. 637-901	<b>24 100 NOK</b>	340	5 309	130

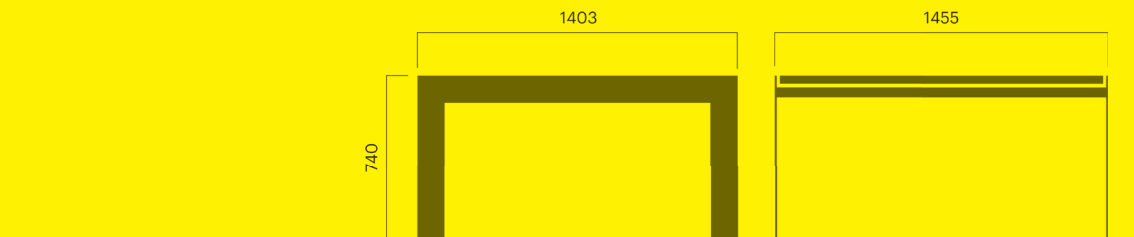

## Vroom avfallsbeholder

80 liter

		kg CO <sub>2</sub> e	MJ	kg
Art. 642-900	17 000 NOK	295	4 106	93
Art. 642-901	14 300 NOK	295	4 106	93

### Rillet front og bakside

Art. 642-900R	17 700 NOK	285	3 982	91
Art. 642-901R	14 900 NOK	285	3 982	91

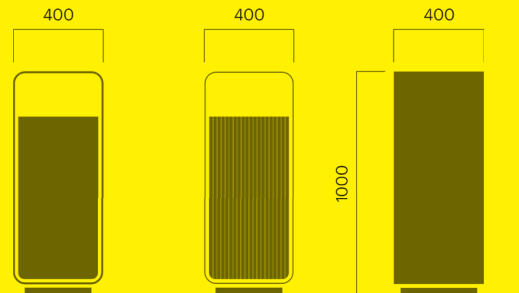

## Vroom avfallsbeholder

140 liter

		kg CO <sub>2</sub> e	MJ	kg
Art. 644-900	18 500 NOK	285	3 982	126
Art. 644-901	16 900 NOK	285	3 982	126

### Rillet front og bakside

Art. 644-900R	19 500 NOK	396	5 514	120
Art. 644-901R	17 500 NOK	396	5 514	120

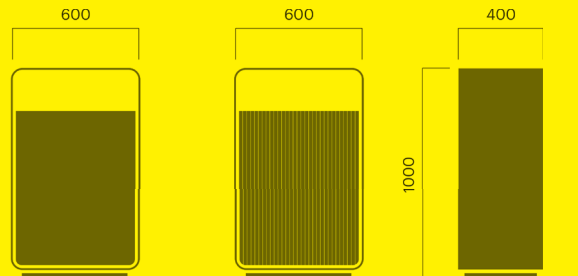

## Vroom plantekasse - T10 mm

50 liter

Liten		kg CO <sub>2</sub> e	MJ	kg
Art. 681-900	9 500 NOK	204	2 848	64
Art. 681-901	8 100 NOK	204	2 848	64

230 liter

Stor		kg CO <sub>2</sub> e	MJ	kg
Art. 684-900	19 900 NOK	533	7 428	169
Art. 684-901	17 500 NOK	533	7 428	169

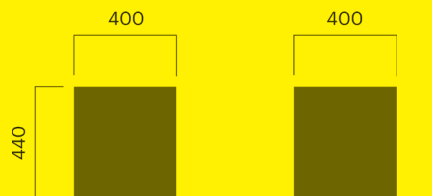

## Vroom sykkelstativ

For 2 sykler

		kg CO <sub>2</sub> e	MJ	kg
<b>Lite, lakkert aluminium</b>				
Art. 686-904A	2 200 NOK	19	319	6
Art. 686-904C	1 900 NOK	21	361	7
<b>Stort, lakkert aluminium</b>				
Art. 696-904A	3 700 NOK	30	503	10
Art. 696-904C	2 400 NOK	25	418	8
<b>A-Sykelstativ</b>				
Art. 694-904A	3 900 NOK	37	615	12
Art. 694-904C	2 600 NOK	31	514	10

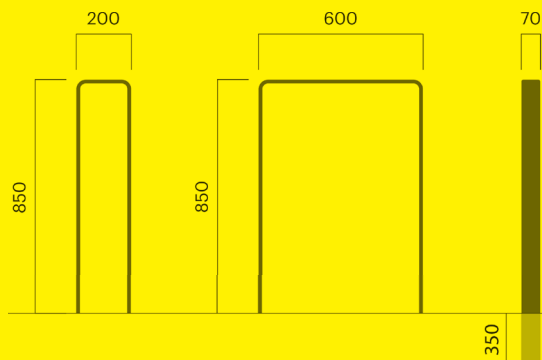

## Vroom sykkelstativ

		kg CO <sub>2</sub> e	MJ	kg
<b>Frittstående stativ for 8 sykler</b>				
Art. 688-900	16 900 NOK	250	3 695	81

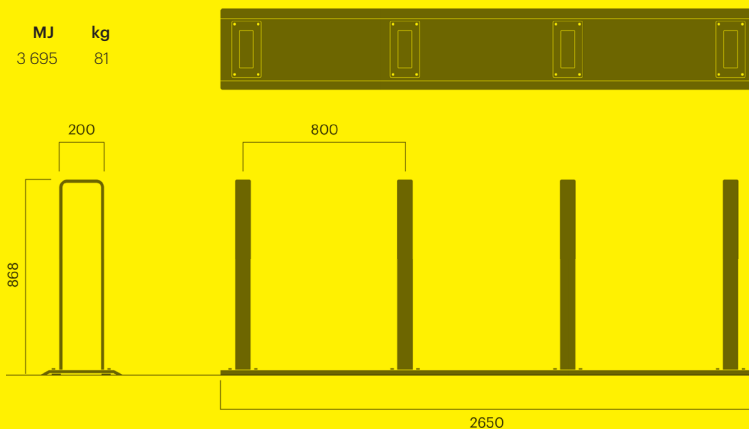

## Ypsilon



### Ypsilon krakk

		kg CO <sub>2</sub> e	MJ	kg
<b>Frittstående eller forankring C</b>				
Art. 6206-900C	12 500 NOK	56	1 057	33
Art. 6206-901C	10 400 NOK	56	1 057	30
Art. 6206-900	12 500 NOK	52	99	31
Art. 6206-901	10 400 NOK	52	99	30

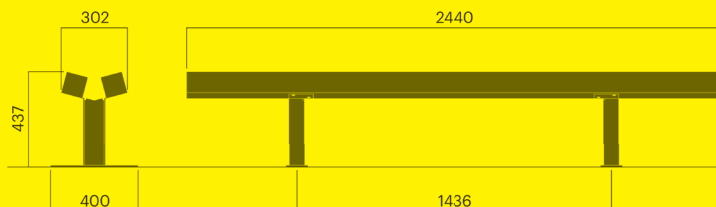

## Ypsilon krakk med armlene

Frittstående eller forankring C		kg CO <sub>2</sub> e	MJ	kg
Art. 6207-900C	<b>14 800 NOK</b>	73	1 297	37
Art. 6207-901C	<b>12 600 NOK</b>	73	1 297	37
Art. 6207-900	<b>14 800 NOK</b>	64	1 168	35
Art. 6207-901	<b>12 600 NOK</b>	64	1 168	35

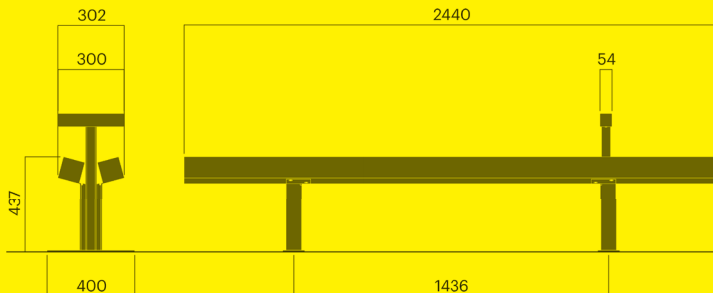

## Ypsilon benk

Frittstående eller forankring C		kg CO <sub>2</sub> e	MJ	kg
Art. 6216-900C	<b>19 800 NOK</b>	153	2 492	59
Art. 6216-901C	<b>17 600 NOK</b>	153	2 492	59
Art. 6216-900	<b>19 800 NOK</b>	102	1 780	51
Art. 6216-901	<b>17 600 NOK</b>	102	1 780	51

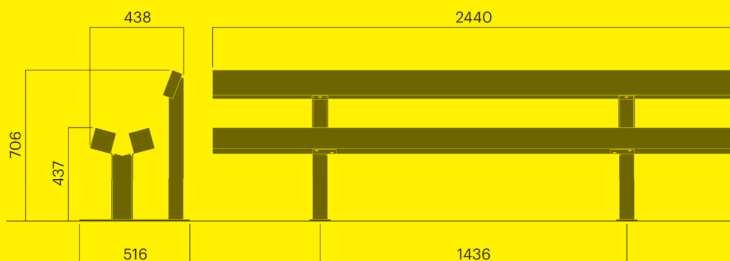

## Ypsilon benk med armlene

Frittstående eller forankring C		kg CO <sub>2</sub> e	MJ	kg
Art. 6217-900C	<b>23 600 NOK</b>	154	2 505	55
Art. 6217-901C	<b>21 400 NOK</b>	154	2 505	55
Art. 6217-900	<b>23 600 NOK</b>	114	1 949	55
Art. 6217-901	<b>21 400 NOK</b>	114	1 949	55

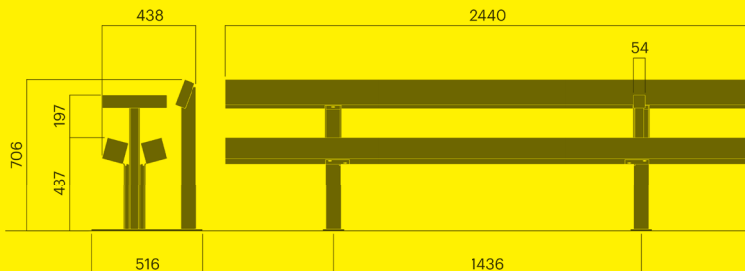

## Ypsilon sirkelkrakk

		kg CO <sub>2</sub> e	MJ	kg
<b>D2800</b>				
Art. 6210-900C	72 300 NOK	-	-	-
Art. 6210-901C	67 300 NOK	-	-	-
Art. 6210-900	69 800 NOK	-	-	-
Art. 6210-901	64 800 NOK	-	-	-
<b>D3500 —</b>				
<b>pris på forespørsel</b>				
Art. 6212-900C		-	-	-
Art. 6212-901C		-	-	-
Art. 6212-900		-	-	-
Art. 6212-901		-	-	-

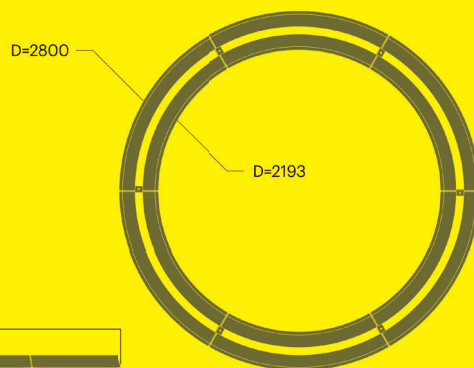

## Ypsilon bord

		kg CO <sub>2</sub> e	MJ	kg
Art. 6238-900	3 000 NOK	12	12	4
Art. 6238-901	2 500 NOK	164	164	4

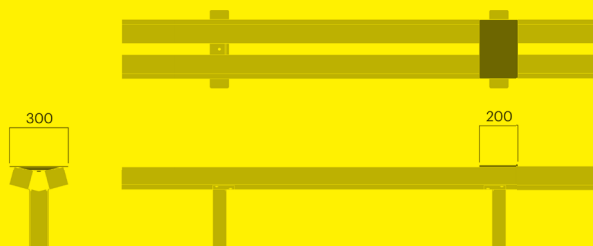



## Ekstra låsenøkkel

		kg CO <sub>2</sub> e	MJ	kg
Art. 90007-901	150 NOK	0	0	0

## City betongfundament

Til City avfallsbeholder 70 l og askebeger 17/60 l		kg CO <sub>2</sub> e	MJ	kg
Art. 267-004	900 NOK	6	220	28
Art. 247-004	1 000 NOK	14	496	58

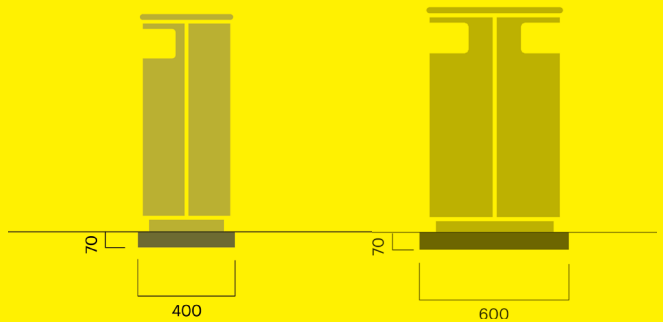

## Nedgravingsfundament

for City og April		kg CO <sub>2</sub> e	MJ	kg
Art. 193-004	400 NOK	6	212	0

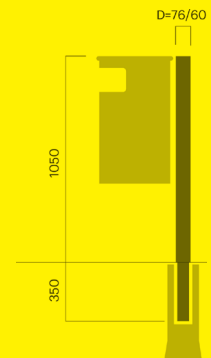

## Tilbehør til planteurner

		MJ	kg
Art. Antigrafitbehandling-	2 000 NOK		0
Art. Feste for plantestøtte-	3 100 NOK-		0

Vanningsystem på forespørsel. Kan leveres med dreneringshull uten ekstra kostnad.

---

## Fuglestopper

Fuglestopper til City 50/70 liter	kg CO <sub>2</sub> e	MJ	kg
Art. 201-902	1 200 NOK	11	200

Fuglestopper til City 150/180 liter	kg CO <sub>2</sub> e	MJ	kg
Art. 202-902	2 200 NOK	18	333

Fuglestopper til Bloc	kg CO <sub>2</sub> e	MJ	kg
Art. 1540-902	3 100 NOK	0	0

Fuglestopperer til andre serier på forespørsel

---

## USB strømuttak

Universalmodell for benker	kg CO <sub>2</sub> e	MJ	kg
Art. 90004-902	5 600 NOK	9	130



---

	kg CO <sub>2</sub> e	MJ	kg
Art. Løftekroker	2 800 NOK	-	-

---



**Norge**

+47 23 00 78 40  
post@vestre.com

**Sverige**

+46 (0)560 688877  
info@vestre.com

**Danmark**

+45 89 88 23 30  
post@vestre.com

**Storbritannia**

+44 (0)207 846 8725  
uk@vestre.com

**Tyskland**

+49 (0)30 407 417 95  
de@vestre.com

**Frankrike**

+49 (0)30 407 417 95  
de@vestre.com

**Sveits**

+49 (0)30 407 417 95  
de@vestre.com

**Benelux**

+49 (0)30 407 417 95  
de@vestre.com

**Østerrike**

+49 (0)30 407 417 95  
de@vestre.com

**USA**

+1 212 634 9658  
usa@vestre.com

**Global Export**

international@vestre.com

Finn din lokale  
salgsrepresentant her.

