

Price list & technical information



All prices are updated in May 2024, quoted net without sales tax and shipping, and apply to standard designs. Furniture comes with linseed oil-impregnated pine as standard, unless otherwise stated. Prices are subject to change without notice. Vestre accepts no liability for printing errors and omissions. Orders shall only become binding upon confirmation of the order.

For updated prices, please visit vestre.com

The product lists use the following system:

XXX-901: The product is hot-dip galvanized, which produces a grey finish with permanent rust protection.

XXX-900: The product is hot-dip galvanized and then powder-coated in a RAL color of the customer's choice.

XXX-902: The product is made from stainless or acidresistant steel, giving it an elegant metallic finish.

XXX-904: The product is made from aluminium and then powder-coated in a RAL color of the customer's choice.

XXX-XXXA: Anchored by a base plate, which is bolted down.

XXX-XXXB: Anchored by means of wall mounting.

XXX-XXXC: Anchored by means of concreting in (some products have an optional pre-cast concrete base, which carries an extra charge).

XXX-XXXD: Demountable, i.e. the product can be removed temporarily, for instance when clearing snow or for traffic.

XXX-XXXMK: The product comes without legs, for mounting directly on top of a wall.

XXX-XXXP: Seat, back and/or table top in perforated steel.

XXX-XXXS: The product swivels (for instance a chair or barstool).

XXX-XXXK: Connection module.

Kg CO2: The product's carbon footprint is provided in kilograms (A1-A3, from raw material to finished product).

MJ: The total energy used in production of the product A1-A3.

* Indicates that we use the environmental impact values from a comparable product.=

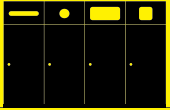

Acceptor 8



Air 11



April 11

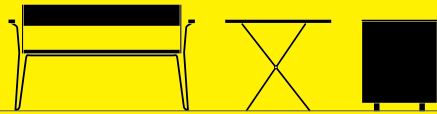

April GO 22



Atlas 26



Berg 28



Berlin 29



Bloc 30



Boboli 43



Bøy 45



Briskeby 46

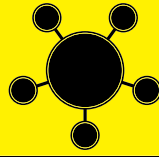

Buzz 47

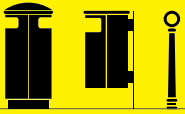

City 48



Coast 53



Code 53



Corner 54

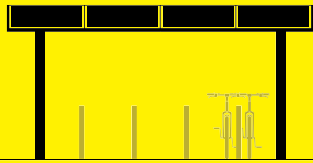

Cover 55

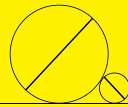

Cycle 55



Dialog 55



Edo 57



Folk 58

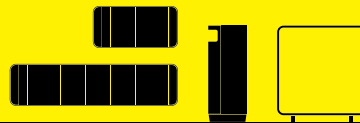

Forum 60



Hill 63



Hvilan 63



Kong 66



Kyoto 67



Move 68

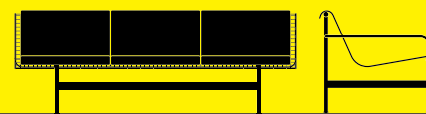

Munch 69

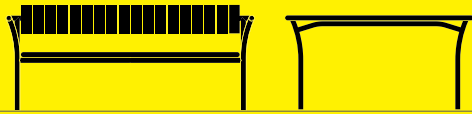

Parc 72

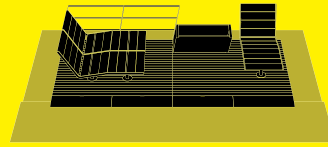

Parklets 2.0 73



Plinth 77

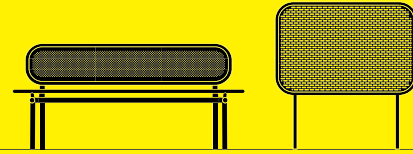

Pop 79



Porto 82



Reale 85



Sinus 87



Stones 88



Stoop 89



Stripes 90



Tour 93

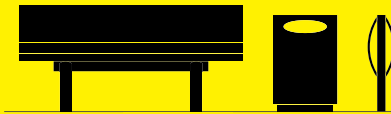

Urban 94



Vega 103

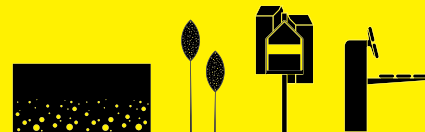

Vestre Habitats 104



Via 107



Vroom 111



Ypsilon 122



Accessories 125



Acceptor recycling receptacle

2 x 15 gallons

		kg CO ₂ e	MJ	lbs
Art. 2142-900	1 990 USD	275	3 838	192
Art. 2142-901	1 680 USD	275	3 838	192

1 x 30 gallons

Art. 2144-900	1 990 USD	278	3 875	194
Art. 2144-901	1 680 USD	278	3 875	194

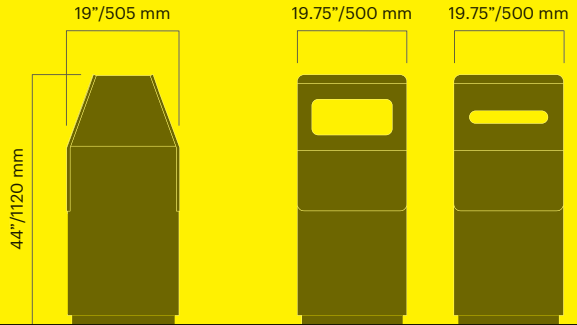

Acceptor recycling receptacle

3 x 29 gallons

		kg CO ₂ e	MJ	lbs
Art. 2192-900	4 270 USD	739	10 746	381
Art. 2192-901	3 750 USD	739	10 746	381

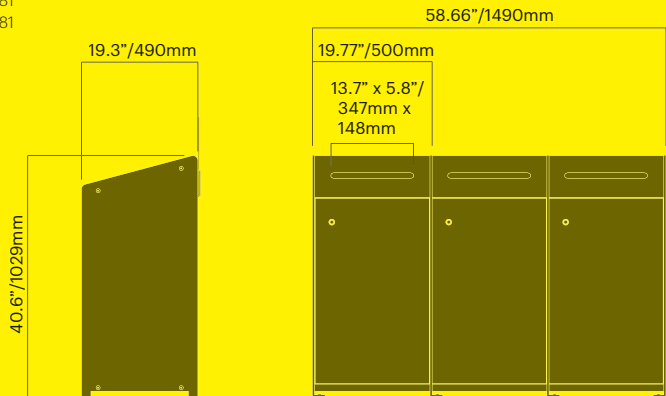

Acceptor recycling receptacle

2 x 42 gallons

		kg CO ₂ e	MJ	lbs
Art. 2145-900	3 570 USD	486	6 779	342
Art. 2145-901	2 950 USD	486	6 779	342

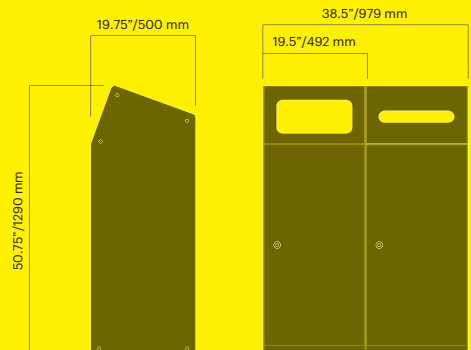

Acceptor recycling receptacle

3 x 42 gallons

		kg CO ₂ e	MJ	lbs
Art. 2146-900	5 330 USD	679	9 473	483
Art. 2146-901	4 480 USD	679	9 473	483

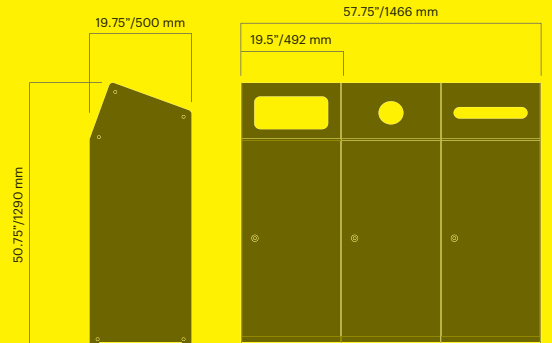

Acceptor recycling receptacle

4 x 42 gallons

		kg CO ₂ e	MJ	lbs
Art. 2147-900	6 870 USD	722	10 481	626
Art. 2147-901	5 990 USD	722	10 481	626

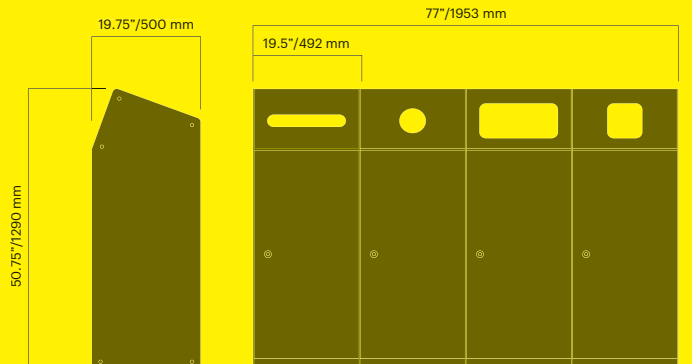

Acceptor aperture

Choose between various sorting options for the Acceptor 42 gal/160 L

Weight: 18 lb/8 kg





Air backless bench

		kg CO ₂ e	MJ	lbs
Art. 3206-900	1 370 USD	79	1 536	67
Art. 3206-901	1 120 USD	79	1 536	67



Air backed bench

		kg CO ₂ e	MJ	lbs
Art. 3217-900	2 480 USD	171	2 740	156
Art. 3217-901	2 280 USD	171	2 740	156

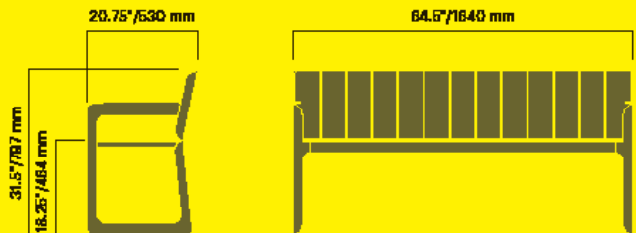

Air table

		kg CO ₂ e	MJ	lbs
Art. 3236-900	1 850 USD	116	1 901	112
Art. 3236-901	1 510 USD	116	1 901	112

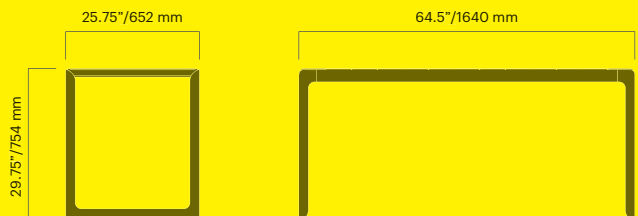



Anchoring options

- A: anchoring with base plate
- B: wall-mounted
- C: concreting in place
- MK: mounting on wall top

S: swivel function - see technical information
(+ 160 USD)

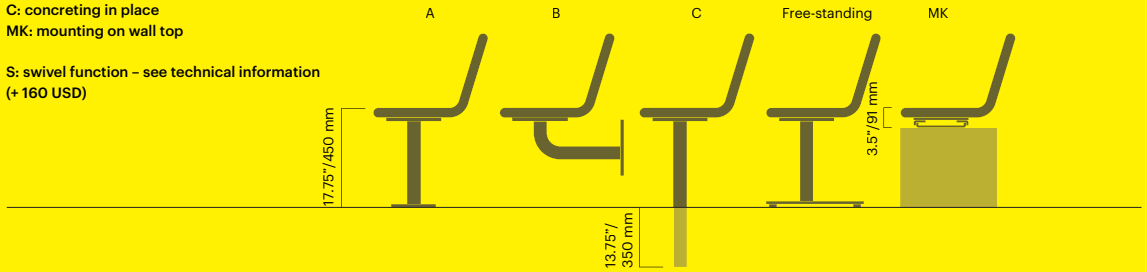

April armrest

April benches and chairs are available with three different armrests.

Standard armrest

Timber armrest
e.g. XXX-XXXWO

Universal armrest (universal design)
e.g. XXX-XXX T

125 USD
Weight: 2 lb/1 kg

Kg CO₂: 1
MJ: 30

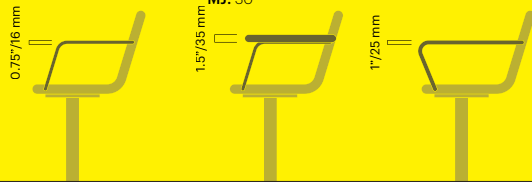

April perforated steel

April benches, chairs and tables are also available with the back, seat and table top in perforated steel.

e.g. XXX-XXX P

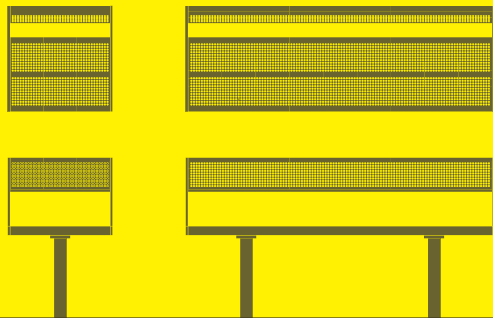

April chair

Anchoring A, B, C or MK		kg CO ₂ e	MJ	lbs
Art. 70-900A	490 USD	38	584	32
Art. 70-901A	440 USD	38	584	32
Art. 70-900B	600 USD	38	589	35
Art. 70-901B	550 USD	38	589	35
Art. 70-900C	470 USD	38	594	34
Art. 70-901C	430 USD	38	594	34
Art. 70-900MK	490 USD	26	420	25
Art. 70-901MK	430 USD	26	420	24
Free-standing				
Art. 71-900	740 USD	57	851	40
Art. 71-901	610 USD	57	851	40

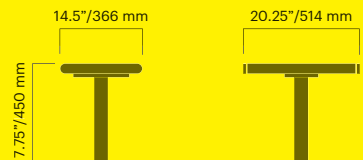

April chair

Anchoring A, B, C or MK		kg CO ₂ e	MJ	lbs
Art. 74-900A	630 USD	50	790	45
Art. 74-901A	550 USD	50	790	45
Art. 74-900B	740 USD	50	790	45
Art. 74-901B	640 USD	50	790	45
Art. 74-900C	610 USD	51	801	46
Art. 74-901C	520 USD	51	801	46
Art. 74-900MK	600 USD	39	631	37
Art. 74-901MK	520 USD	39	631	37

Free-standing

Art. 75-900	850 USD	69	1 055	58
Art. 75-901	770 USD	69	1 055	58

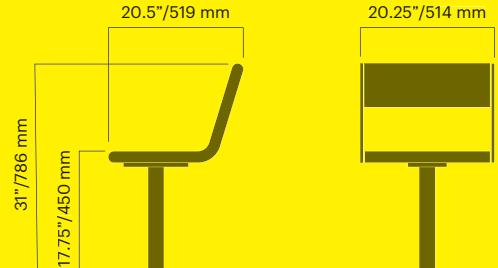

April chair

Anchoring A, B, C or MK		kg CO ₂ e	MJ	lbs
Art. 76-900AT	720 USD	69	1 055	58
Art. 76-901AT	610 USD	69	1 055	58
Art. 76-900BT	820 USD	69	1 057	59
Art. 76-901BT	690 USD	69	1 057	59

Anchoring A, B, C or MK

Art. 76-900CT	700 USD	70	1 069	59
Art. 76-901CT	600 USD	70	1 069	59
Art. 76-900MK	700 USD	45	725	42
Art. 76-901MK	590 USD	45	725	42

Free-standing

Art. 77-900T	950 USD	76	1 154	72
Art. 77-901T	820 USD	76	1 154	72

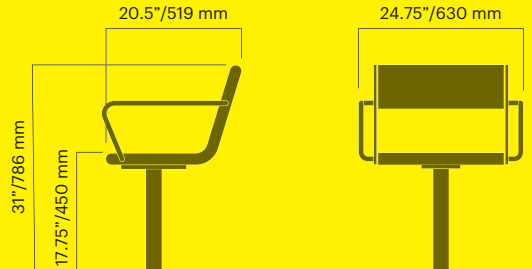

April chair high back

With armrest, anchoring A or C		kg CO ₂ e	MJ	lbs
Art. 763-900A	1 060 USD	71	1 244	77
Art. 763-901A	970 USD	71	1 244	77
Art. 763-900C	1 060 USD	73	1 267	79
Art. 763-901C	950 USD	73	1 267	79

Without armrest, anchoring A or C

Art. 764-900AT	1 350 USD	91	1 520	90
Art. 764-901AT	1 230 USD	91	1 520	90
Art. 764-900CT	1 330 USD	93	1 544	93
Art. 764-901CT	1 210 USD	93	1 544	93

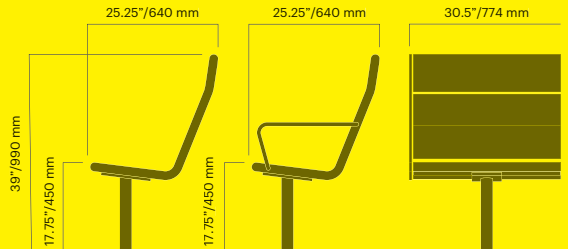

April bar stool

Anchoring A or C		kg CO ₂ e	MJ	lbs
Art. 78-900A	950 USD	70	1 085	61
Art. 78-901A	890 USD	70	1 085	61
Art. 78-900C	930 USD	71	1 100	60
Art. 78-901C	870 USD	71	1 100	60
Free-standing				
Art. 78-900	1 370 USD	129	1 902	93
Art. 78-901	1 280 USD	129	1 902	101

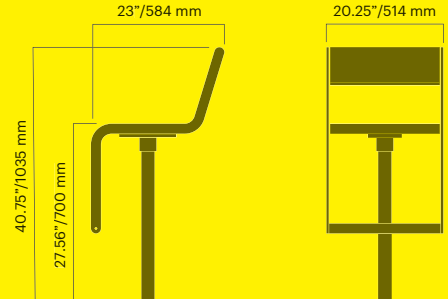

April bar stool

		kg CO ₂ e	MJ	lbs
Art. 79-900A	1 140 USD	38	584	60
Art. 79-901A	980 USD	38	584	60
Art. 79-900C	1 120 USD	38	594	60
Art. 79-901C	950 USD	38	594	60
Art. 79-900	1 480 USD	125	1 845	98
Art. 79-901	1 330 USD	125	1 845	98

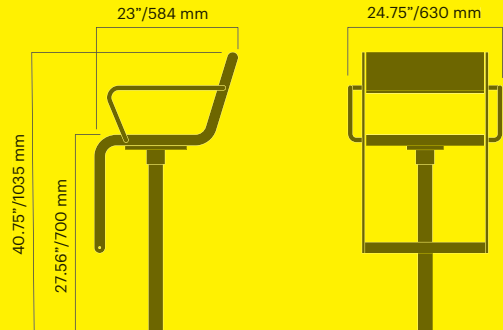

April backless bench

Anchoring A, B, C or MK		kg CO ₂ e	MJ	lbs
Art. 703-900A	850 USD	67	1 134	69
Art. 703-901A	720 USD	67	1 134	69
Art. 703-900B	950 USD	70	1 170	71
Art. 703-901B	820 USD	70	1 170	71
Art. 703-900C	790 USD	69	1 162	71
Art. 703-901C	670 USD	69	1 162	70
Art. 703-900MK	740 USD	44	810	53
Art. 703-901MK	630 USD	44	810	53
Free-standing				
Art. 706-900	970 USD	76	1 260	75
Art. 706-901	860 USD	76	1 260	75

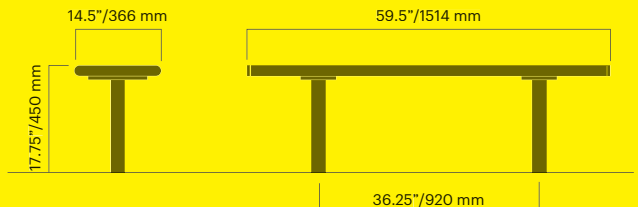

April backless bench

Anchoring A, B, C or MK		kg CO ₂ e	MJ	lbs
Art. 704-900A	1 230 USD	77	1 265	76
Art. 704-901A	1 050 USD	77	1 265	76
Art. 704-900B	1 370 USD	79	1 303	77
Art. 704-901B	1 220 USD	79	1 303	77
Art. 704-900C	1 180 USD	77	1 265	77
Art. 704-901C	990 USD	77	1 265	77
Art. 704-900MK	1 200 USD	53	941	59
Art. 704-901MK	1 020 USD	53	941	76

Free-standing

Art. 707-900	1 370 USD	86	1 396	82
Art. 707-901	1 240 USD	86	1 396	82

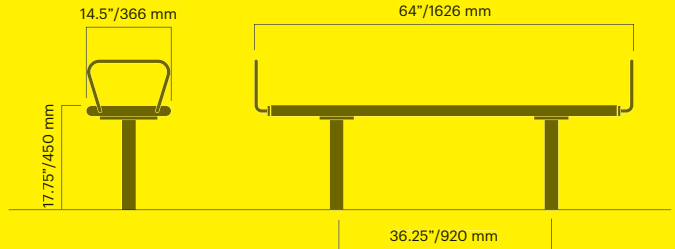

April backed bench

Anchoring A, B, C or MK		kg CO ₂ e	MJ	lbs
Art. 713-900A	980 USD	83	1 446	90
Art. 713-901A	870 USD	83	1 446	90
Art. 713-900B	1 160 USD	83	1 456	91
Art. 713-901B	1 020 USD	83	1 456	91
Art. 713-900C	910 USD	84	1 470	92
Art. 713-901C	800 USD	84	1 470	92
Art. 713-900MK	950 USD	51	799	74
Art. 713-901MK	800 USD	51	799	74

Free-standing

Art. 716-900	1 160 USD	96	1 629	100
Art. 716-901	980 USD	96	1 629	100

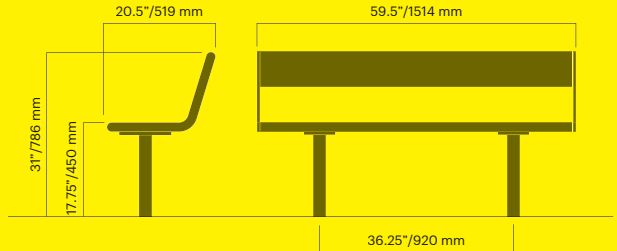

April backed bench

		kg CO ₂ e	MJ	lbs
Art. 714-900A	1 160 USD	89	1 535	95
Art. 714-901A	970 USD	89	1 535	95
Art. 714-900B	1 280 USD	106	1 774	95
Art. 714-901B	1 060 USD	106	1 774	95
Art. 714-900C	1 110 USD	91	1 559	96
Art. 714-901C	930 USD	91	1 559	96
Art. 714-900MK	1 040 USD	59	1 118	79
Art. 714-901MK	870 USD	59	1 118	79

Free-standing

Art. 717-900	1 230 USD	102	1 719	104
Art. 717-901	1 060 USD	102	1 719	104

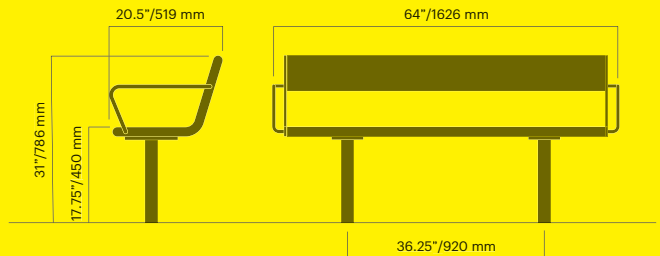

April sun bench

Anchoring A or C		kg CO ₂ e	MJ	lbs
Art. 766-900A	1 950 USD	149	2 588	159
Art. 766-901A	1 740 USD	145	2 546	159
Art. 766-900C	1 900 USD	149	2 588	162
Art. 766-901C	1 690 USD	145	2 546	162

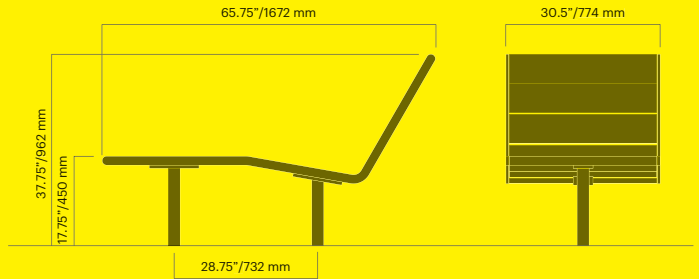

April backed bench high back

Anchoring A or C		kg CO ₂ e	MJ	lbs
Art. 768-900A	1 660 USD	101	1 898	121
Art. 768-901A	1 480 USD	101	1 898	123
Art. 768-900C	1 610 USD	102	1 903	126
Art. 768-901C	1 420 USD	102	1 903	126

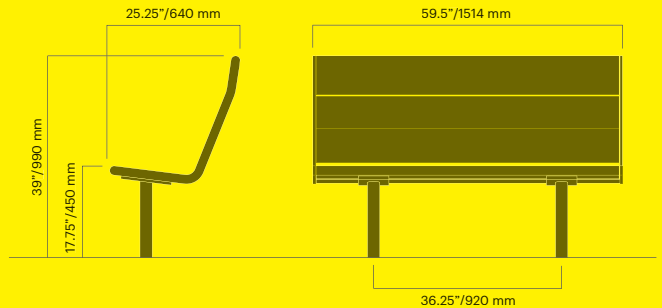

April backed bench high back

Anchoring A or C		kg CO ₂ e	MJ	lbs
Art. 769-900AT	1 990 USD	118	2 128	137
Art. 769-901AT	1 740 USD	118	2 128	137
Art. 769-900CT	1 940 USD	121	2 180	139
Art. 769-901CT	1 690 USD	121	2 180	139

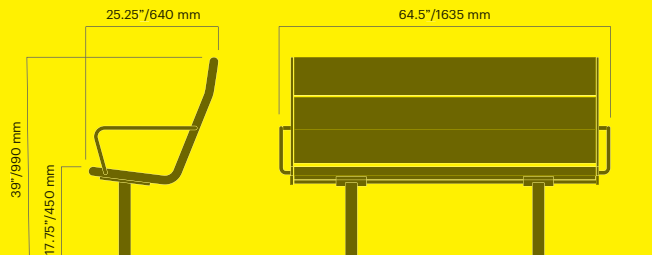

April steel table

Low, anchoring A or C

		kg CO ₂ e	MJ	lbs
Art. 732-900A	440 USD	50	698	35
Art. 732-901A	370 USD	50	698	35
Art. 732-900C	420 USD	51	713	36
Art. 732-901C	350 USD	51	713	36

High, anchoring A or C

Art. 730-900A	450 USD	57	797	37
Art. 730-901A	370 USD	57	797	37
Art. 730-900C	430 USD	59	817	40
Art. 730-901C	350 USD	59	817	40

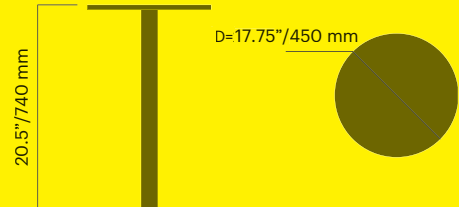

April round table small

Anchoring A or C

		kg CO ₂ e	MJ	lbs
Art. 731-900A	1 020 USD	69	1 096	63
Art. 731-901A	930 USD	69	1 096	63
Art. 731-900C	980 USD	70	1 109	64
Art. 731-901C	900 USD	70	1 109	64

Free-standing

Art. 731-900	1 320 USD	96	1 467	82
Art. 731-901	1 180 USD	96	1 467	82

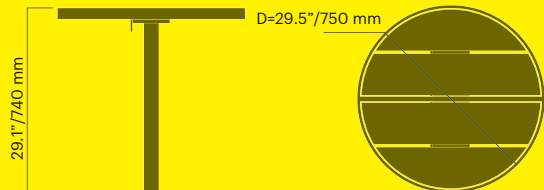

April round table

Anchoring A or C

		kg CO ₂ e	MJ	lbs
Art. 737-900A	1 350 USD	94	1 610	99
Art. 737-901A	1 230 USD	94	1 610	99
Art. 737-900C	1 330 USD	95	1 619	99
Art. 737-901C	1 210 USD	95	1 619	99

Free-standing

Art. 738-900	1 920 USD	31	740	136
Art. 738-901	1 740 USD	31	740	136

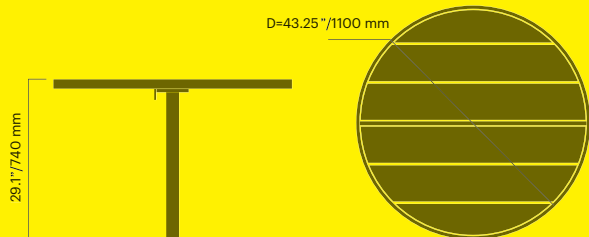

April square table

Anchoring A or C		kg CO ₂ e	MJ	lbs
Art. 734-900A	800 USD	66	1 091	65
Art. 734-901A	710 USD	66	1 091	65
Art. 734-900C	780 USD	67	1 100	66
Art. 734-901C	680 USD	67	1 100	66
Free-standing				
Art. 735-900	1 070 USD	92	1 457	84
Art. 735-901	970 USD	92	1 457	84

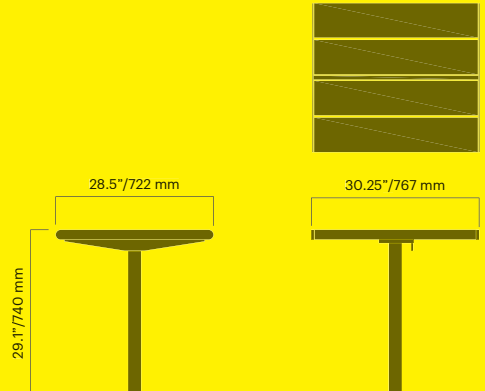

April standard table

Anchoring A or C		kg CO ₂ e	MJ	lbs
Art. 733-900A	1 240 USD	110	1 914	120
Art. 733-901A	1 060 USD	110	1 914	120
Art. 733-900C	1 200 USD	111	1 937	121
Art. 733-901C	1 020 USD	111	1 937	121
Free-standing				
Art. 736-900	1 460 USD	127	2 158	132
Art. 736-901	1 230 USD	127	2 158	132



April standard table

Adapted for wheelchair

Anchoring A or C		kg CO ₂ e	MJ	lbs
Art. 739-900A	1 330 USD	112	1 979	125
Art. 739-901A	1 120 USD	112	1 979	125
Art. 739-900C	1 280 USD	114	2 007	127
Art. 739-901C	1 060 USD	114	2 007	127
Free-standing				
Art. 739-900	1 490 USD	130	2 227	138
Art. 739-901	1 260 USD	130	2 227	138

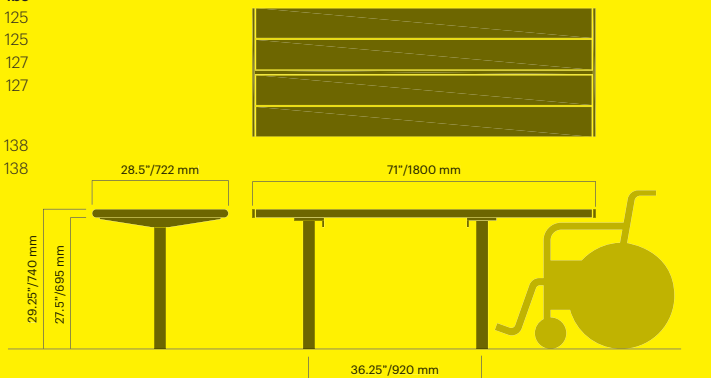

April bar table

		kg CO ₂ e	MJ	lbs
Art. 741-900A	1 070 USD	97	1 632	82
Art. 741-901A	930 USD	97	1 632	79
Art. 741-900C	1 030 USD	98	1 651	82
Art. 741-901C	890 USD	98	1 651	82

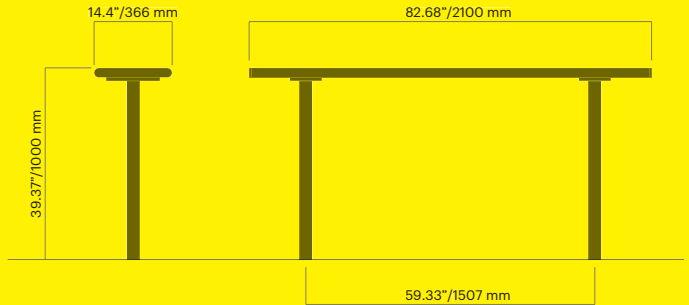

April picnic table

Without backrests		kg CO ₂ e	MJ	lbs
Art. 751-900	2 950 USD	311	4 909	319
Art. 751-901	2 640 USD	311	4 909	274

Backrest one side

Art. 753-900	3 330 USD	326	5 412	340
Art. 753-901	2 880 USD	326	5 412	326

Backrest both sides

Art. 752-900	3 700 USD	339	5 631	362
Art. 752-901	3 080 USD	339	5 631	348

ADA model with backrest one side

Art. 753-900H	3 760 USD	344	5 794	346
Art. 753-901H	3 120 USD	344	5 794	326

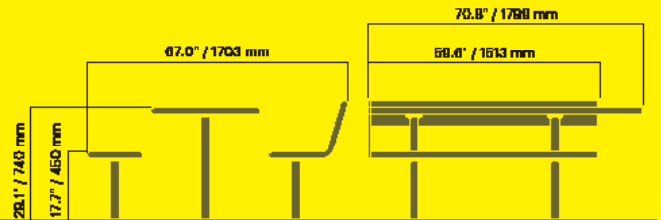

April litter receptacle

20 gallons		kg CO ₂ e	MJ	lbs
Art. 780-900	1 480 USD	112	1 574	78
Art. 780-901	1 240 USD	112	1 574	78

25 gallons

Art. 782-900	1 620 USD	128	1 791	88
Art. 782-901	1 370 USD	128	1 791	88

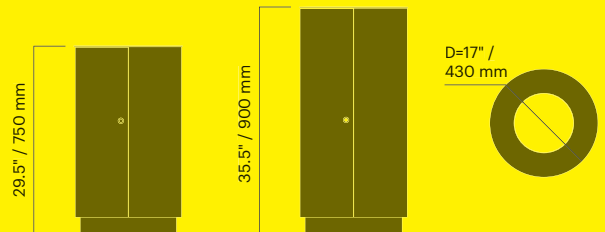

April litter receptacle

38 gallons		kg CO ₂ e	MJ	lbs
Art. 784-900	1 850 USD	154	2 153	108
Art. 784-901	1 610 USD	154	2 153	106
46 gallons		kg CO ₂ e	MJ	lbs
Art. 786-900	2 090 USD	176	2 450	132
Art. 786-901	1 780 USD	176	2 450	132

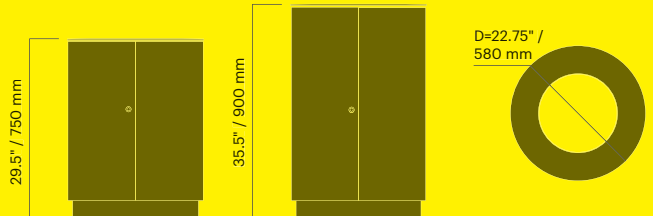

April litter receptacle

20 gallons		kg CO ₂ e	MJ	lbs
Art. 770-900	1 990 USD	184	2 572	86
Art. 770-901	1 780 USD	184	2 572	86
25 gallons		kg CO ₂ e	MJ	lbs
Art. 772-900	2 110 USD	237	3 307	106
Art. 772-901	1 900 USD	237	3 307	106

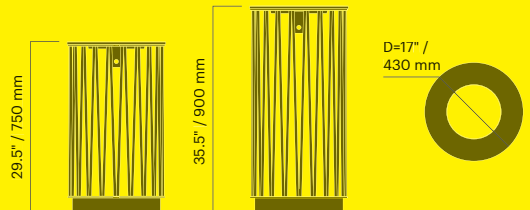

April litter receptacle

38 gallons		kg CO ₂ e	MJ	lbs
Art. 774-900	2 280 USD	180	2 514	123
Art. 774-901	2 050 USD	180	2 514	121
46 gallons		kg CO ₂ e	MJ	lbs
Art. 776-900	2 400 USD	325	4 541	148
Art. 776-901	2 190 USD	325	4 541	148

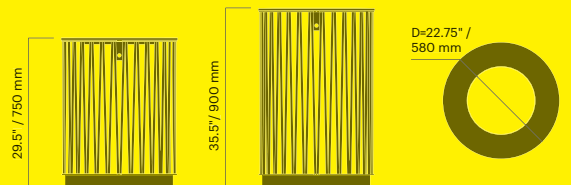

April backless bench

Anchoring A, B, C or MK		kg CO ₂ e	MJ	lbs
Art. 720-900A	900 USD	72	1204	71
Art. 720-901A	780 USD	72	1204	71
Art. 720-900B	960 USD	72	1204	73
Art. 720-901B	990 USD	72	1204	73
Art. 720-900C	850 USD	72	1204	73
Art. 720-901C	730 USD	72	1204	73
Art. 720-900MK	810 USD	47	852	55
Art. 720-901MK	700 USD	47	852	55

Free-standing

Art. 721-900	1 040 USD	79	1298	78
Art. 721-901	910 USD	79	1298	78

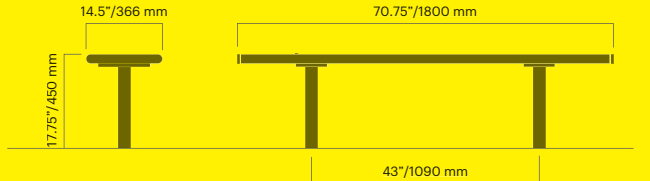

April backless bench

Anchoring A, B, C or MK		kg CO ₂ e	MJ	lbs
Art. 722-900A	1 170 USD	86	1406	79
Art. 722-901A	1 050 USD	86	1406	79
Art. 722-900B	1 230 USD	88	1434	79
Art. 722-901B	1 120 USD	88	1434	79
Art. 722-900C	1 120 USD	88	1434	79
Art. 722-901C	1 000 USD	88	1335	79
Art. 722-900MK	1 060 USD	55	974	79
Art. 722-901MK	1 010 USD	55	974	79

Free-standing

Art. 722-900	1 330 USD	88	1434	110
Art. 722-901	1 210 USD	88	1434	110

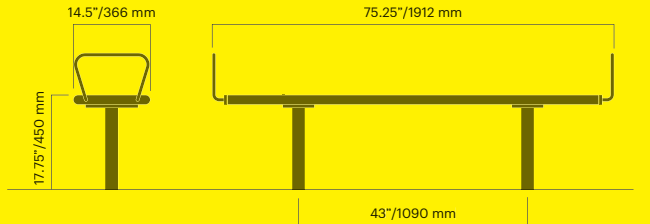

April backed bench

Anchoring A, B, C or MK		kg CO ₂ e	MJ	lbs
Art. 723-900A	1 160 USD	86	1553	99
Art. 723-901A	970 USD	86	1553	99
Art. 723-900B	1 290 USD	87	1557	100
Art. 723-901B	1 110 USD	87	1557	100
Art. 723-900C	1 110 USD	88	1576	101
Art. 723-901C	930 USD	88	1576	101
Art. 723-900MK	1 040 USD	63	1224	83
Art. 723-901MK	900 USD	63	1224	83

Free-standing

Art. 726-900	1 240 USD	99	1735	109
Art. 726-901	1 080 USD	99	1735	109

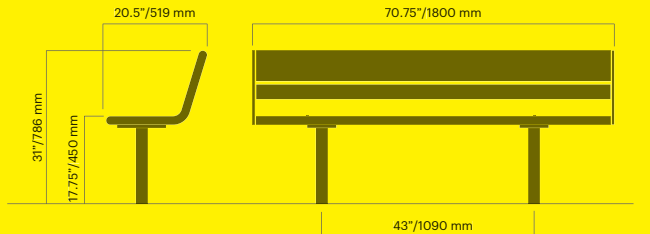

April backed bench

		kg CO ₂ e	MJ	lbs
Art. 724-900A	1 330 USD	93	1 646	104
Art. 724-901A	1 120 USD	93	1 646	104
Art. 724-900B	1 400 USD	93	1 646	104
Art. 724-901B	1 330 USD	93	1 646	104
Art. 724-900C	1 280 USD	95	1 679	105
Art. 724-901C	1 060 USD	95	1 679	105
Art. 724-900MK	1 280 USD	69	1 313	88
Art. 724-901MK	1 060 USD	69	1 313	88

Free-standing

Art. 727-900	1 490 USD	105	1 820	113
Art. 727-901	1 320 USD	105	1 820	154

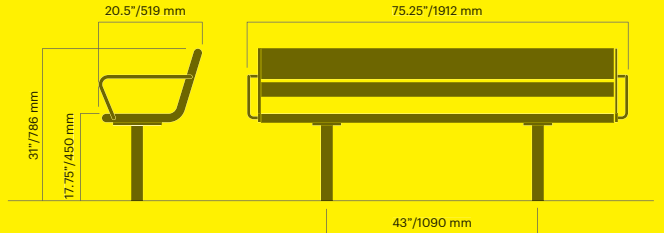

April table

Anchoring A or C

		kg CO ₂ e	MJ	lbs
Art. 743-900A	1 240 USD	112	1 979	125
Art. 743-901A	1 110 USD	112	1 979	125
Art. 743-900C	1 200 USD	114	2 003	127
Art. 743-901C	1 050 USD	114	2 003	127

Free-standing

Art. 746-900	1 460 USD	129	2 223	138
Art. 746-901	1 240 USD	129	2 223	138

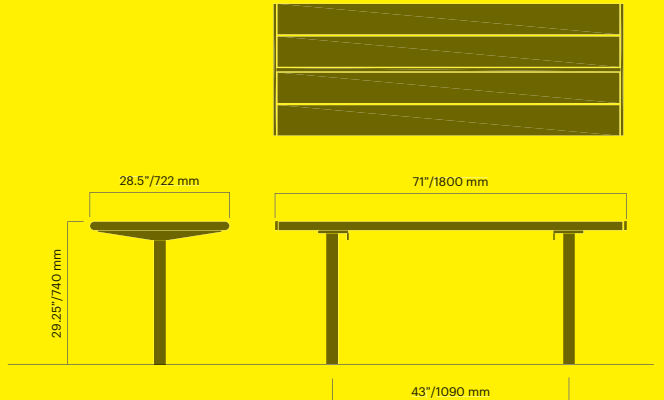

April picnic table

Without backrests

		kg CO ₂ e	MJ	lbs
Art. 755-900	3 370 USD	317	5 248	329
Art. 755-901	2 870 USD	317	5 248	315

Backrest one side

Art. 757-900	3 610 USD	326	5 230	357
Art. 757-901	3 200 USD	326	5 230	344

Backrest both sides

Art. 756-900	3 750 USD	341	5 549	385
Art. 756-901	3 360 USD	341	5 549	398

Without backrests junior size model 14"/22"

Art. 755-900JR	3 200 USD	317	5 248	306
Art. 755-901JR	2 730 USD	317	5 248	313

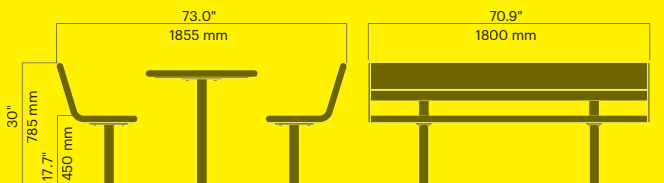



April Go chair

Seat and back in powder-coated aluminium		kg CO ₂ e	MJ	lbs
Art. 7013-330	490 USD	37	553	28
Art. 7013-331	460 USD	37	553	29

Seat and back in wood		kg CO ₂ e	MJ	lbs
Art. 7013-900	520 USD	30	448	28
Art. 7013-901	460 USD	30	448	24

Stackable

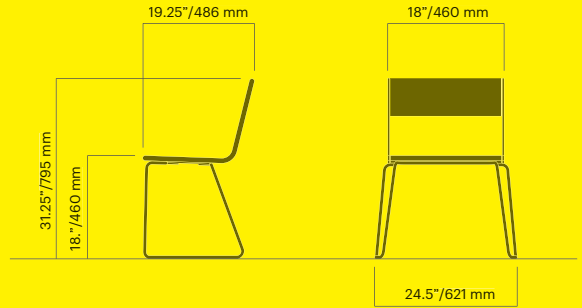

April Go chair

Seat and back in powder-coated aluminium		kg CO ₂ e	MJ	lbs
Art. 7014-330	680 USD	40	612	31
Art. 7014-331	610 USD	40	612	31

Seat and back in wood		kg CO ₂ e	MJ	lbs
Art. 7014-900	690 USD	33	500	30
Art. 7014-901	620 USD	33	500	29

Stackable

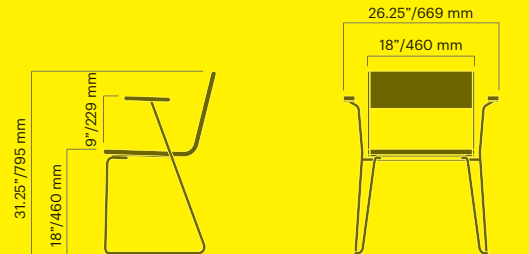

April Go lounge chair

Seat and back in wood		kg CO ₂ e	MJ	lbs
Art. 7064-900	675 USD	32	485	26
Art. 7064-901	565 USD	32	485	28

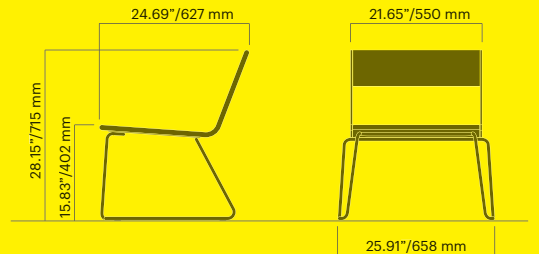

April Go bar stool

Seat and back in wood		kg CO ₂ e	MJ	lbs
Art. 7018-900	675 USD	32	475	31
Art. 7018-901	550 USD	32	475	31

Stackable

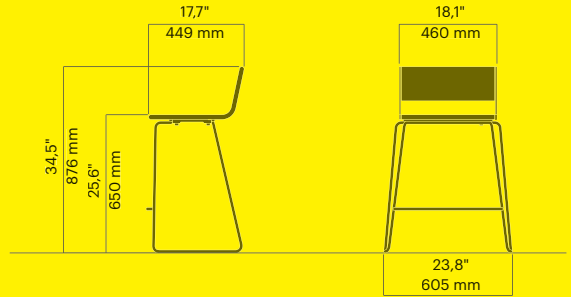

April Go backless bench

Seat in powder-coated aluminium		kg CO ₂ e	MJ	lbs
Art. 7006-330	640 USD	36	572	34
Art. 7006-331	590 USD	36	572	33

Seat in wood		kg CO ₂ e	MJ	lbs
Art. 7006-900	720 USD	36	572	32
Art. 7006-901	620 USD	36	572	34

Stackable

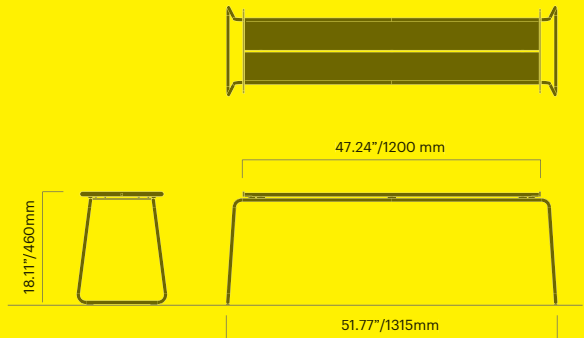

April Go backed bench

Seat and back in powder-coated aluminium		kg CO ₂ e	MJ	lbs
Art. 7015-330	850 USD	60	922	49
Art. 7015-331	720 USD	60	922	49

Seat and back in wood		kg CO ₂ e	MJ	lbs
Art. 7015-900	910 USD	44	708	40
Art. 7015-901	790 USD	44	708	40

With armrest, seat and back in wood		kg CO ₂ e	MJ	lbs
Art. 7016-900	1 090 USD	47	760	43
Art. 7016-901	970 USD	47	760	43

Stackable

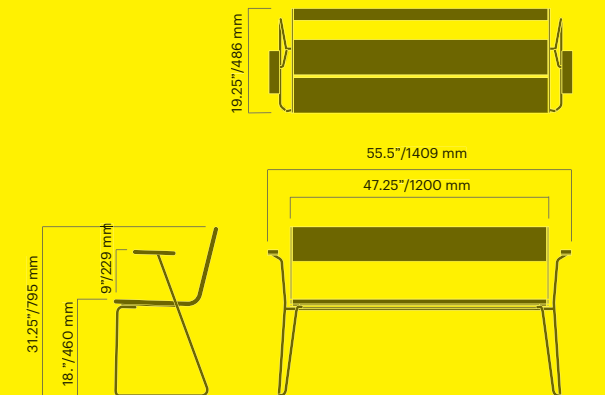

April Go folding table

Table top in wood

		kg CO ₂ e	MJ	lbs
Art. 7033-900	860 USD	38	503	28
Art. 7033-901	840 USD	38	503	27

Table top in powder-coated aluminium

Art. 7033-330	1 090 USD	50	777	36
Art. 7033-331	990 USD	50	777	35

Foldable

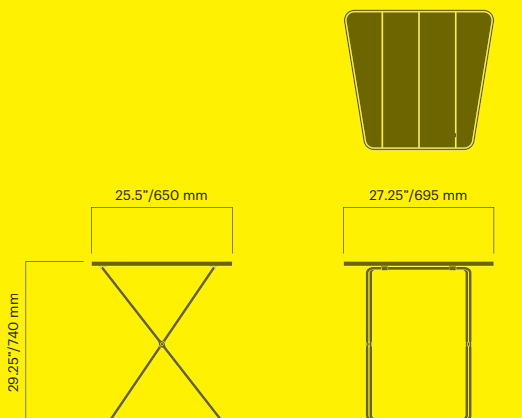

April Go round folding table

Table top in wood

		kg CO ₂ e	MJ	lbs
Art. 7037-900	1 230 USD	47	752	53
Art. 7037-901	1 090 USD	47	752	53

Foldable

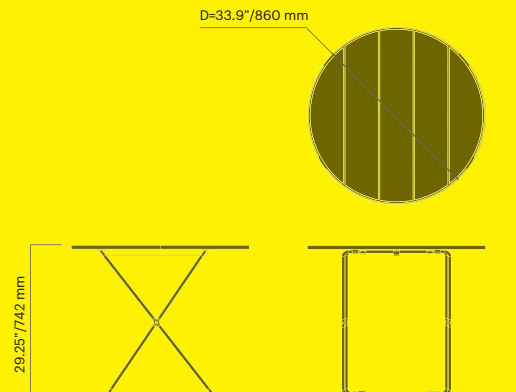

April Go rectangular folding table

Table top in wood

		kg CO ₂ e	MJ	lbs
Art. 7036-330	1 410 USD	64	1 198	79
Art. 7036-331	1 270 USD	64	1 198	79
Art. 7036-900	1 390 USD	64	1 198	59
Art. 7036-901	1 140 USD	64	1 198	59

Foldable



April Go lounge table

Table top in wood		kg CO ₂ e	MJ	lbs
Art. 7030-900	640 USD	37	544	33
Art. 7030-901	540 USD	37	544	33



April Go planter

		kg CO ₂ e	MJ	lbs
H390/D650, 220 gal				
Art. 7080-900	1 010 USD	86	1 202	64
Art. 7080-901	910 USD	86	1 202	64
H570/D650, 331 gal				
Art. 7081-900	1 060 USD	131	1 818	84
Art. 7081-901	970 USD	131	1 818	84
H790/D650, 463 gal				
Art. 7082-900	1 230 USD	162	2 257	132
Art. 7082-901	1 090 USD	162	2 257	132

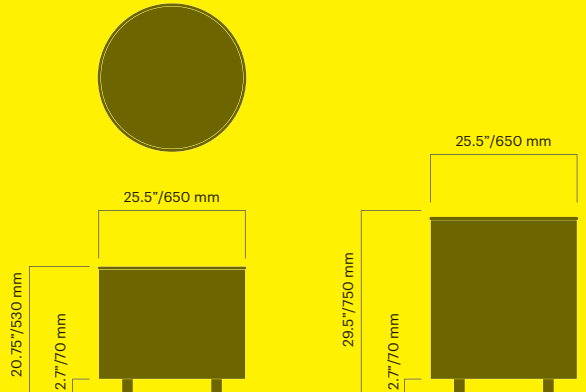

April Go planter

		kg CO ₂ e	MJ	lbs
H15.35"/D35.43", 40 gal				
Art. 7083-900	1 110 USD	165	2 300	107
Art. 7083-901	990 USD	165	2 300	107
H22.44"/D35.43", 79 gal				
Art. 7084-900	1 390 USD	201	2 805	163
Art. 7084-901	1 150 USD	201	2 805	163
H33.07"/D35.43", 122 gal				
Art. 7085-900	1 920 USD	220	3 069	157
Art. 7085-901	1 830 USD	220	3 069	154
H37.00"/D35.43", 211 gal				
Art. 7087-900	3 030 USD	498	6 930	371
Art. 7087-901	2 790 USD	498	6 930	370

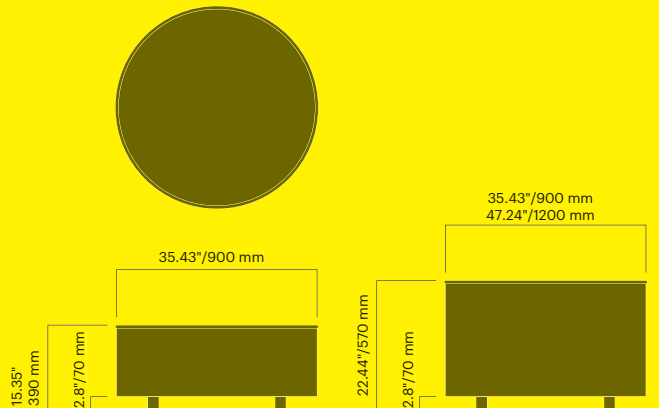



Atlas backless bench

		kg CO ₂ e	MJ	lbs
2-seater				
Art. 4502-900	2 050 USD	159	2 007	154
Art. 4502-901	1 740 USD	159	2 007	154
3-seater				
Art. 4503-900	2 820 USD	225	3 394	186
Art. 4503-901	2 390 USD	225	3 394	185
4-seater				
Art. 4504-900	3 650 USD	290	4 392	287
Art. 4504-901	3 100 USD	290	4 392	287

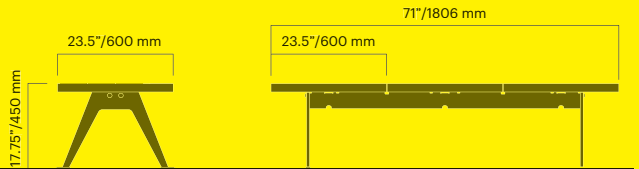

Atlas backed bench

		kg CO ₂ e	MJ	lbs
2-seater				
Art. 4512-900	3 000 USD	235	3 725	198
Art. 4512-901	2 760 USD	235	3 725	198
3-seater				
Art. 4513-900	4 200 USD	198	2 982	293
Art. 4513-901	3 930 USD	198	2 982	293
4-seater				
Art. 4514-900	5 490 USD	434	6 937	384
Art. 4514-901	5 140 USD	434	6 937	384

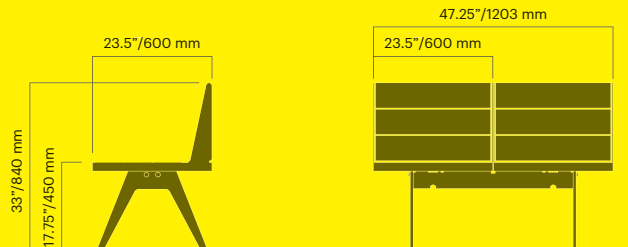

Atlas double backed bench

		kg CO ₂ e	MJ	lbs
Art. 4527-900	7 190 USD	589	9 283	529
Art. 4527-901	6 680 USD	589	9 283	530
With 2 armrests				
Art. 4528-900	7 770 USD	620	9 710	556
Art. 4528-901	7 170 USD	620	9 710	555

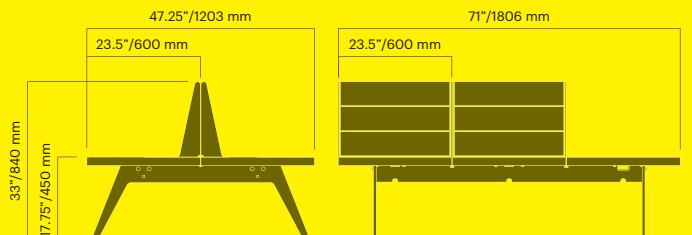

Atlas backless bench

Seat without back

		kg CO ₂ e	MJ	lbs
Art. 4520-900	640 USD	31	523	32
Art. 4520-901	550 USD	31	523	32

Seat curved

Art. 4530-900	1 290 USD	86	1 391	82
Art. 4530-901	1 210 USD	86	1 391	82

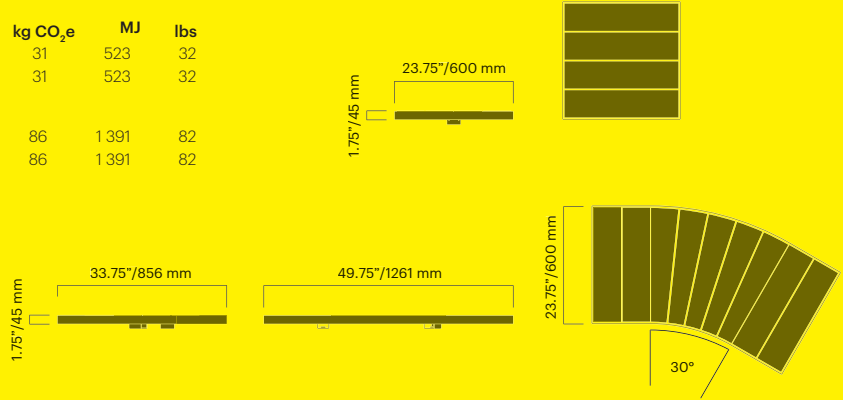

Atlas backed bench

		kg CO ₂ e	MJ	lbs
Art. 4521-900	1 100 USD	67	1 157	72
Art. 4521-901	1 060 USD	67	1 157	72

With wide armrest left (V) or right (H)

Art. 4526-900V	1 300 USD	83	1 392	84
Art. 4526-901V	1 210 USD	83	1 392	84
Art. 4526-900H	1 300 USD	83	1 392	84
Art. 4526-901H	1 210 USD	83	1 392	84

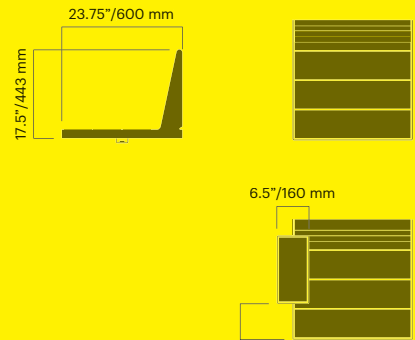

Atlas leg structure

Frame 2-seater

		kg CO ₂ e	MJ	lbs
Art. 4550-900	770 USD	101	1 407	71
Art. 4550-901	630 USD	101	1 407	71

Frame 3-seater

Art. 4551-900	900 USD	131	1 864	91
Art. 4551-901	740 USD	131	1 864	91

Frame 4-seater

Art. 4552-900	1 080 USD	165	2 296	115
Art. 4552-901	900 USD	165	2 296	115

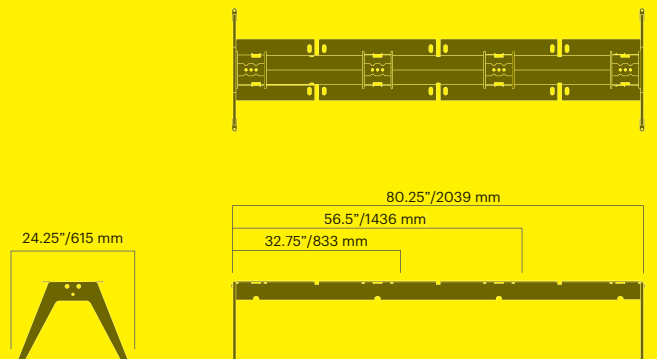

Atlas leg structure

Frame 4-seater (2+2)

		kg CO ₂ e	MJ	lbs
Art. 4560-900	1 290 USD	193	2 697	139
Art. 4560-901	1 120 USD	193	2 697	139

Frame 6-seater (3+3)

Art. 4561-900	1 640 USD	258	3 593	180
Art. 4561-901	1 340 USD	258	3 593	180

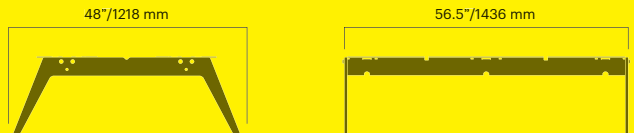
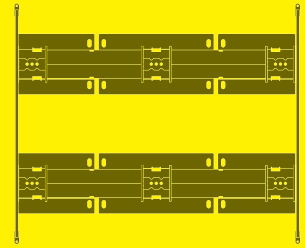

Berg



Berg picnic table

		kg CO ₂ e	MJ	lbs
Art. 322-900	1 990 USD	106	1 934	128
Art. 322-901	1 780 USD	106	1 934	128

Adapted for wheelchair

Art. 322-900HC	2 110 USD	136	2 465	143
Art. 322-901HC	1 880 USD	136	2 465	143

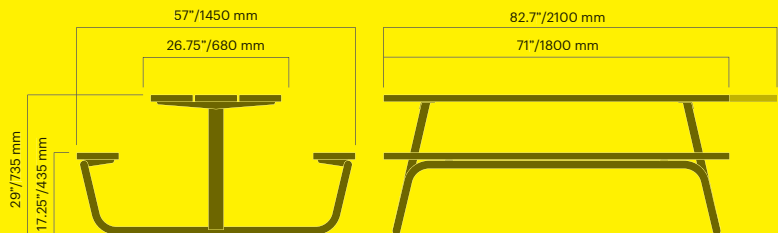

Berg bike rack

For 6 bikes

		kg CO ₂ e	MJ	lbs
Art. 393-900	1 030 USD	110	1 534	66
Art. 393-901	870 USD	110	1 534	66

For 8 bikes

Art. 395-900	1 280 USD	150	2 083	68
Art. 395-901	1 100 USD	150	2 083	68

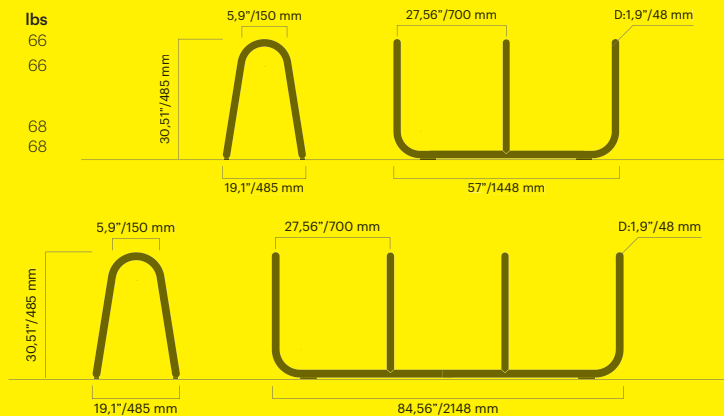

Berlin



Berlin chair

Anchoring A or C		kg CO ₂ e	MJ	lbs
Art. 3713-900A	1 400 USD	74	1150	61
Art. 3713-901A	1 280 USD	74	1150	58
Art. 3713-900C	1 370 USD	77	1192	65
Art. 3713-901C	1 230 USD	77	1192	65

Anchoring A or C with armrests		kg CO ₂ e	MJ	lbs
Art. 3717-900A	1 590 USD	90	1371	77
Art. 3717-901A	1 490 USD	90	1371	77
Art. 3717-900C	1 580 USD	92	1398	75
Art. 3717-901C	1 460 USD	92	1398	75

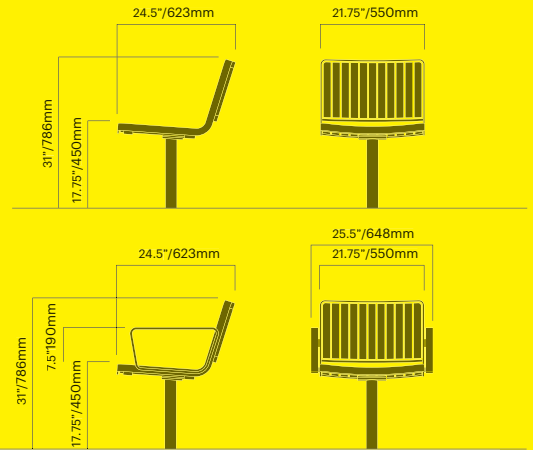

Berlin chair

Free-standing		kg CO ₂ e	MJ	lbs
Art. 3718-900	1 700 USD	93	1405	70
Art. 3718-901	1 570 USD	93	1405	70

Free-standing with armrests		kg CO ₂ e	MJ	lbs
Art. 3717-900	1 810 USD	97	1464	79
Art. 3717-901	1 660 USD	97	1464	79

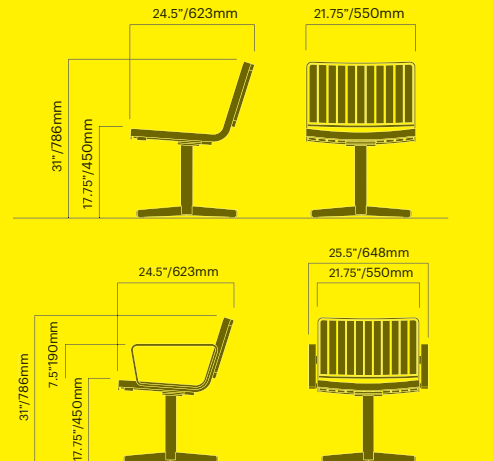

Berlin small table

Anchoring A or C		kg CO ₂ e	MJ	lbs
Art. 3731-900A	740 USD	64	896	43
Art. 3731-901A	610 USD	64	896	43
Art. 3731-900C	720 USD	65	905	43
Art. 3731-901C	590 USD	65	905	43

Free-standing		kg CO ₂ e	MJ	lbs
Art. 3731-900	870 USD	72	999	49
Art. 3731-901	740 USD	72	999	47

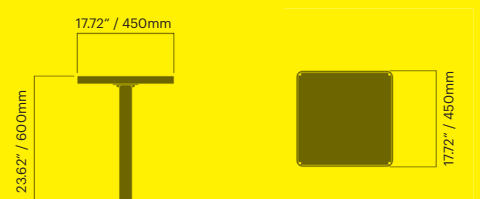

Berlin large table

Anchoring A or C		kg CO ₂ e	MJ	lbs
Art. 3733-900A	1 120 USD	141	1 965	100
Art. 3733-901A	980 USD	141	1 965	100
Art. 3733-900C	1 060 USD	142	1 975	98
Art. 3733-901C	960 USD	142	1 975	99
Free-standing				
Art. 3733-900	1 240 USD	147	2 054	103
Art. 3733-901	1 110 USD	147	2 054	103

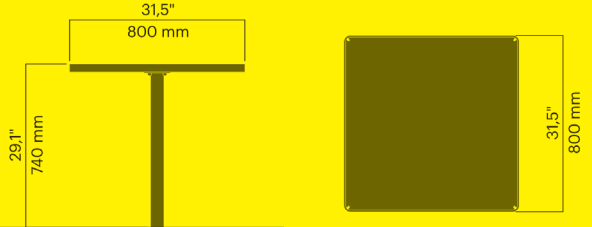

Bloc



Bloc chair

		kg CO ₂ e	MJ	lbs
Art. 1503-900	1 480 USD	180	2 672	143
Art. 1503-901	1 230 USD	180	2 672	143
With armrests				
Art. 1504-900	1 620 USD	199	2 934	156
Art. 1504-901	1 320 USD	199	2 934	156

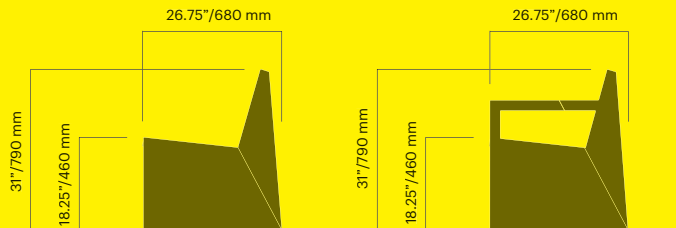
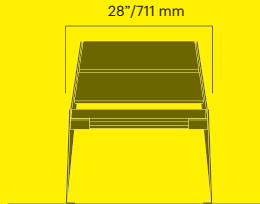

Bloc barchair without backrests

		kg CO ₂ e	MJ	lbs
Art. 1521-900	1 460 USD	144	2 285	123
Art. 1521-901	1 300 USD	144	2 285	123

* GWP & MJ proxy based on 1506-900

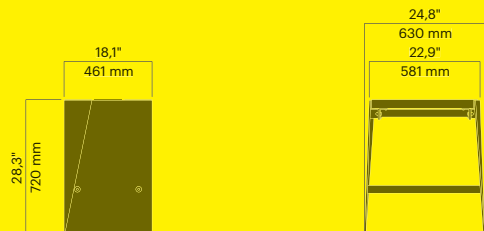

Bloc barchair with backrests

		kg CO ₂ e	MJ	lbs
Art. 1523-900	1 810 USD	234	3 478	168
Art. 1523-901	1 460 USD	234	3 478	168

* GWP & MJ proxy based on 1503-900

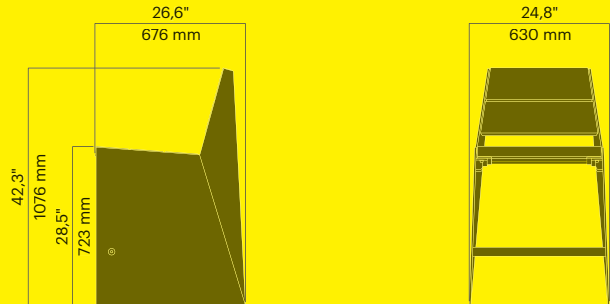

Bloc backless bench

		kg CO ₂ e	MJ	lbs
Art. 1506-900	1 270 USD	145	2 304	132
Art. 1506-901	1 140 USD	145	2 304	132

Start module

Art. 1507-901	1 230 USD	152	2 398	136
Art. 1507-900	1 400 USD	152	2 398	136

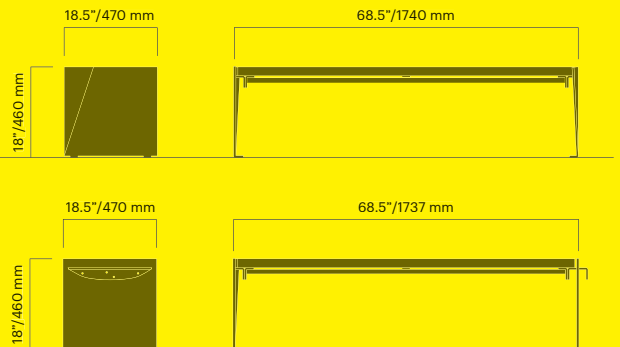

Bloc backless bench

		kg CO ₂ e	MJ	lbs
Art. 1508-901	950 USD	99	1 665	101
Art. 1508-900	1 070 USD	99	1 665	101

End module

Art. 1509-900	1 020 USD	94	1 590	97
Art. 1509-901	890 USD	94	1 590	97

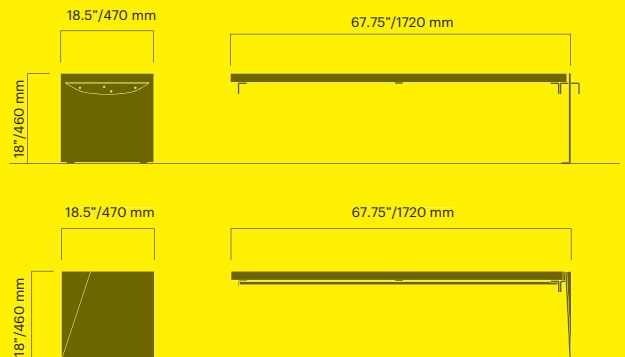

Bloc backed bench

		kg CO ₂ e	MJ	lbs
Art. 1516-900	1 740 USD	201	3 273	194
Art. 1516-901	1 500 USD	201	3 273	193

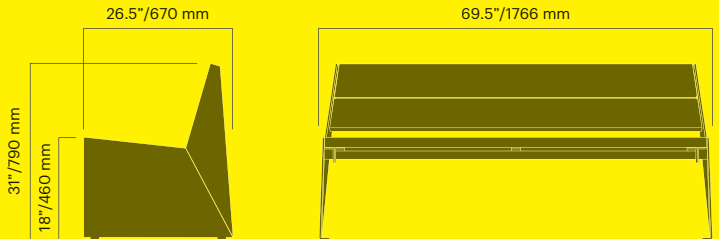

Bloc backed bench start module

		kg CO ₂ e	MJ	lbs
Art. 1553-900	1 980 USD	209	3 374	197
Art. 1553-901	1 680 USD	209	3 374	197

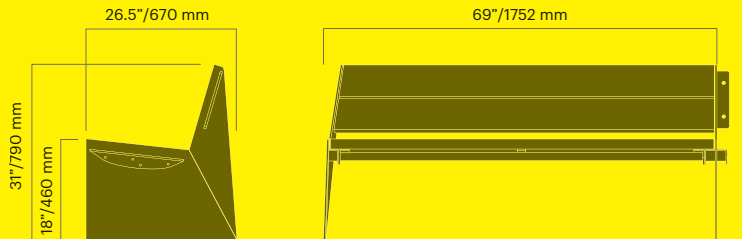

Bloc backed bench add-on module

		kg CO ₂ e	MJ	lbs
Art. 1554-900	1 560 USD	134	2 351	146
Art. 1554-901	1 350 USD	134	2 351	146

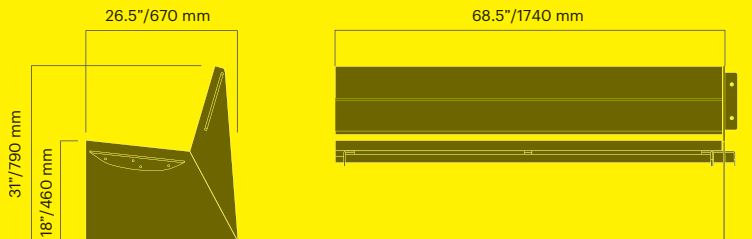

Bloc backed bench end module

		kg CO ₂ e	MJ	lbs
Art. 1555-900	1 460 USD	127	2 230	139
Art. 1555-901	1 240 USD	127	2 230	139

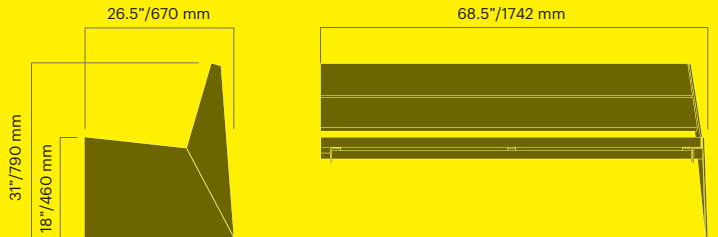

Bloc backed bench

With armrests		kg CO ₂ e	MJ	lbs
Art. 1517-900	1 980 USD	221	3 546	206
Art. 1517-901	1 610 USD	221	3 546	207

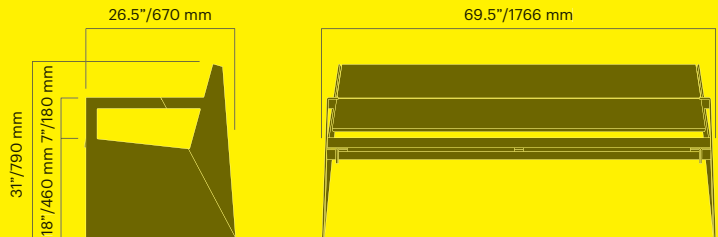

Bloc backed bench start module

With armrests		kg CO ₂ e	MJ	lbs
Art. 1556-900	2 090 USD	218	3 505	204
Art. 1556-901	1 720 USD	218	3 505	204

With 2 armrests for connection

Art. 1559-900	2 120 USD	218	3 505	211
Art. 1559-901	1 750 USD	218	3 505	212

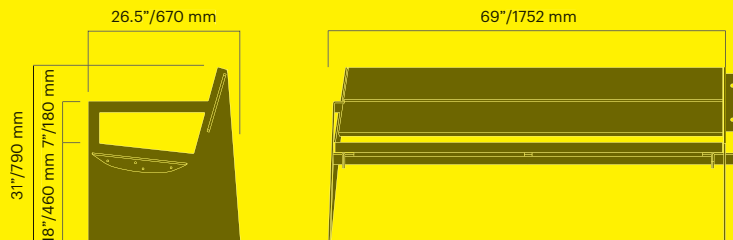

Bloc backed bench add-on module

With armrests		kg CO ₂ e	MJ	lbs
Art. 1557-900	1 570 USD	144	2 478	150
Art. 1557-901	1 410 USD	144	2 478	150

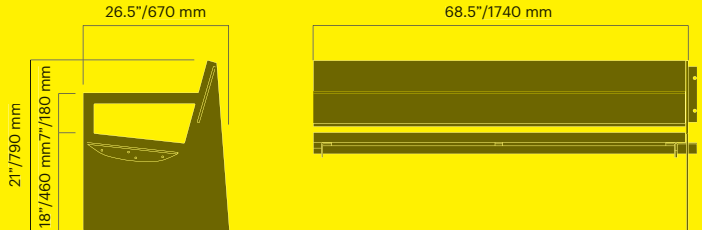

Bloc backed bench end module

With armrests		kg CO ₂ e	MJ	lbs
Art. 1558-900	1 510 USD	136	2 361	146
Art. 1558-901	1 280 USD	136	2 361	146

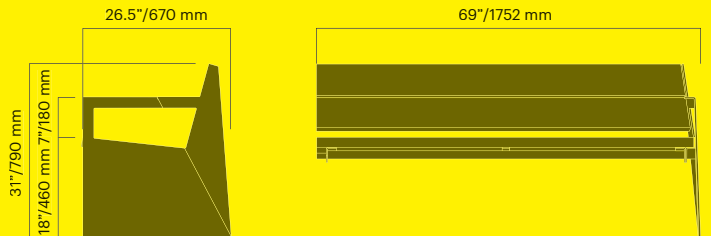

Bloc backed bench double back to back

Complete backed bench back to back		kg CO ₂ e	MJ	lbs
Art. 1532-900	4 270 USD	442	7 201	423
Art. 1532-901	3 560 USD	442	7 201	423

Start module back to back

Art. 1574-900	4 250 USD	456	7 381	432
Art. 1574-901	3 700 USD	456	7 381	432

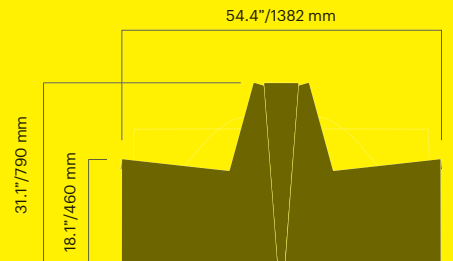

Bloc backed bench double back to back

		kg CO ₂ e	MJ	lbs
Complete backed bench back to back with armrests				
Art. 1534-900	4 440 USD	480	7 730	449
Art. 1534-901	3 750 USD	480	7 730	449
Start module back to back with armrests at the end				
Art. 1571-900	4 270 USD	476	7 655	445
Art. 1571-901	3 810 USD	476	7 655	445
Start module back to back with armrests for connection				
Art. 1570-900	4 440 USD	476	7 655	458
Art. 1570-901	3 800 USD	476	7 655	459

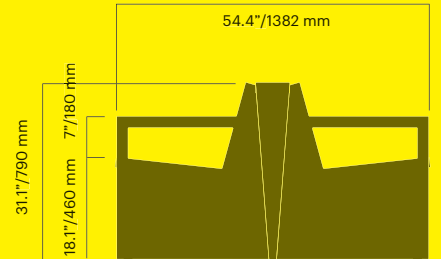

Bloc backed bench back to back add-on modules

		kg CO ₂ e	MJ	lbs
Without armrests				
Art. 1572-900	2 810 USD	282	4 779	290
Art. 1572-901	2 710 USD	282	4 779	290
With armrests				
Art. 1533-900	2 920 USD	300	5 032	302
Art. 1533-901	2 650 USD	300	5 032	302



Bloc backed bench back to back end modules

		kg CO ₂ e	MJ	lbs
Without armrests				
Art. 1575-900	3 320 USD	274	4 849	305
Art. 1575-901	2 810 USD	274	4 849	305
With armrests				
Art. 1573-900	3 360 USD	385	5 832	318
Art. 1573-901	2 910 USD	385	5 832	318

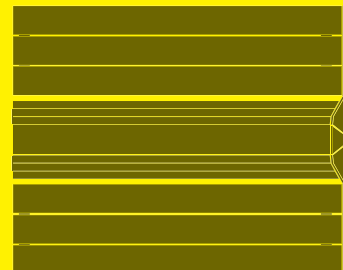

Bloc sun bench

		kg CO ₂ e	MJ	lbs
Art. 1566-900	2 810 USD	303	4 970	296
Art. 1566-901	2 310 USD	303	4 970	295

Narrow model

Art. 1565-900	2 680 USD	303	4 970	265
Art. 1565-901	2 220 USD	303	4 970	265

Optional wheels for moving 410 USD

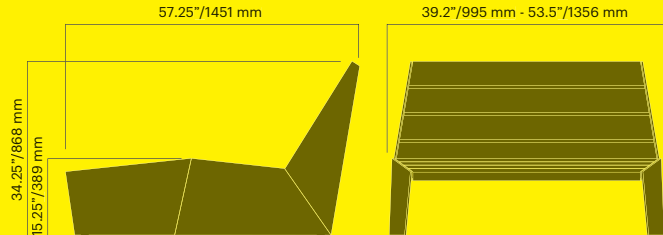

Bloc sun bench start module

		kg CO ₂ e	MJ	lbs
Art. 1567-900	3 040 USD	316	5 173	306
Art. 1567-901	2 470 USD	316	5 173	306

Connection module for short seat

Art. 1567-900K	2 910 USD	312	5 115	306
Art. 1567-901K	2 430 USD	312	5 115	306

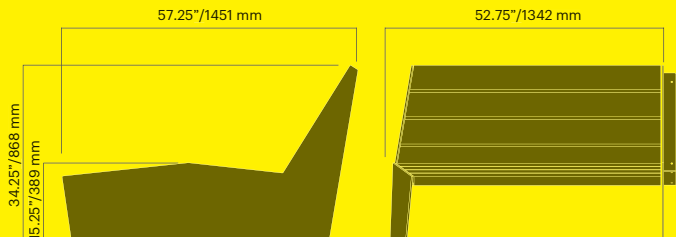

Bloc sun bench add-on module

		kg CO ₂ e	MJ	lbs
Art. 1568-900	2 330 USD	187	3 347	214
Art. 1568-901	2 160 USD	187	3 347	214

Connection module for short seat

Art. 1568-900K	2 270 USD	183	3 288	203
Art. 1568-901K	2 110 USD	183	3 288	203

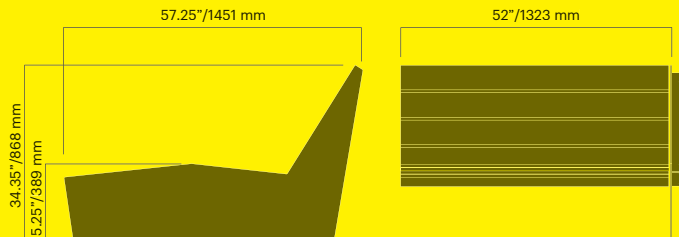

Bloc sun bench end module

		kg CO ₂ e	MJ	lbs
Art. 1569-900	2 090 USD	175	3 180	208
Art. 1569-901	1 780 USD	175	3 180	208

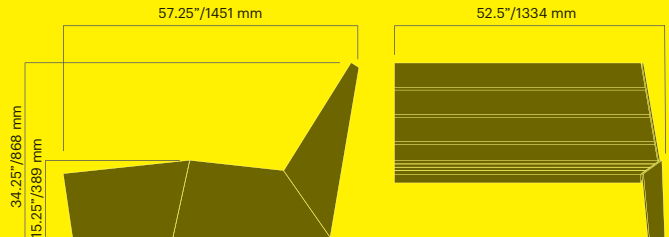

Bloc sun bench back connection

		kg CO ₂ e	MJ	lbs
Art. 1560-901	980 USD	67	1 009	55
Art. 1560-900	1 120 USD	67	1 009	55

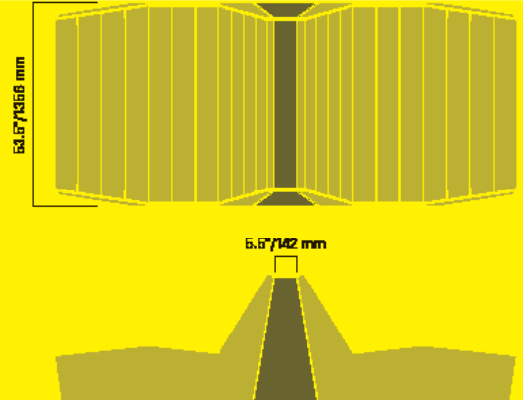

Bloc sun bench back connection

Start module

		kg CO ₂ e	MJ	lbs
Art. 1561-901	980 USD	127	1 849	44
Art. 1561-900	1 120 USD	127	1 849	44

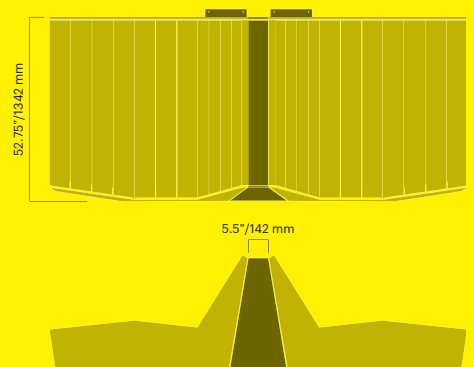

Bloc sun bench back connection

Add-on module

		kg CO ₂ e	MJ	lbs
Art. 1562-900	730 USD	63	957	93
Art. 1562-901	600 USD	63	957	93

End module

Art. 1563-900	730 USD	67	1 009	53
Art. 1563-901	600 USD	67	1 009	53

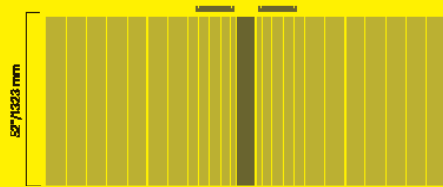

Bloc short sun bench

		kg CO ₂ e	MJ	lbs
Art. 1576-900	1 990 USD	194	3 185	189
Art. 1576-901	1 730 USD	194	3 185	189

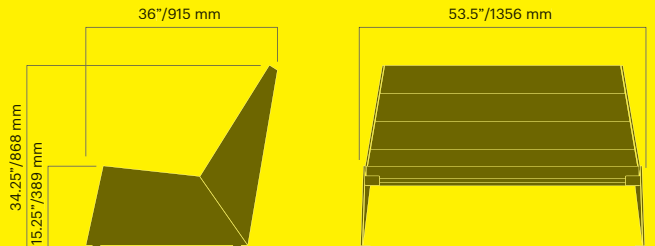

Bloc short sun bench start module

		kg CO ₂ e	MJ	lbs
Art. 1577-900	2 110 USD	239	3 816	287
Art. 1577-901	1 900 USD	239	3 816	287

Connection module for long seat

Art. 1577-900K	2 490 USD	274	4 367	287
Art. 1577-901K	2 230 USD	274	4 367	287

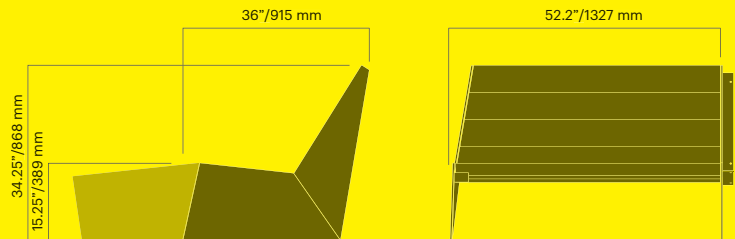

Bloc short sun bench add-on module

		kg CO ₂ e	MJ	lbs
Art. 1578-900	1 560 USD	152	2 454	143
Art. 1578-901	1 350 USD	152	2 454	143

Connection module for long seat

Art. 1578-900K	1 810 USD	181	3 005	143
Art. 1578-901K	1 570 USD	181	3 005	143

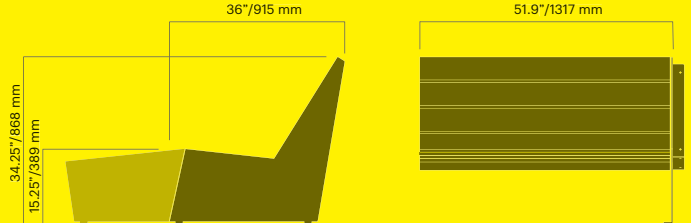

Bloc short sun bench end module

		kg CO ₂ e	MJ	lbs
Art. 1579-900	1 480 USD	108	1 862	157
Art. 1579-901	1 350 USD	108	1 862	157

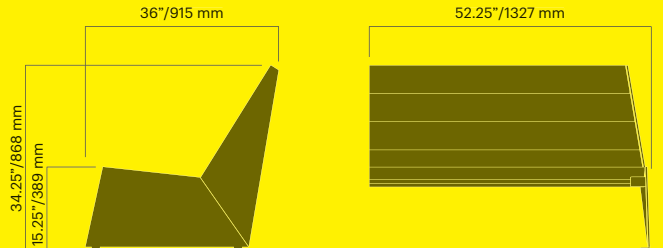

Bloc low table

		kg CO ₂ e	MJ	lbs
Art. 1530-900	1 420 USD	155	2 372	131
Art. 1530-901	1 340 USD	155	2 372	131

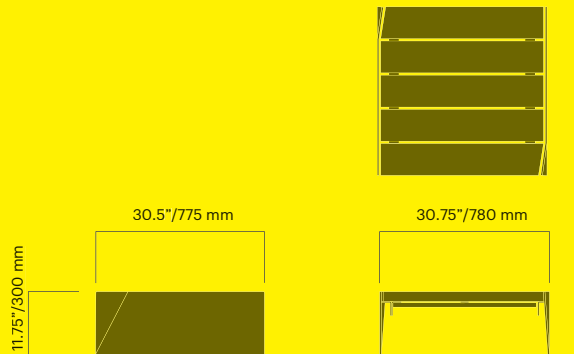

Bloc table

		kg CO ₂ e	MJ	lbs
Art. 1536-900	1 980 USD	273	4 180	226
Art. 1536-901	1 730 USD	273	4 180	226

Start module

Art. 1537-900	1 980 USD	273	4 180	232
Art. 1537-901	1 700 USD	273	4 180	245

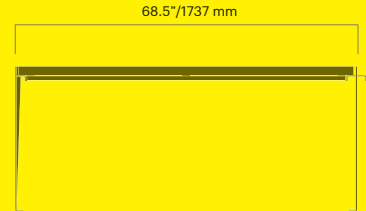
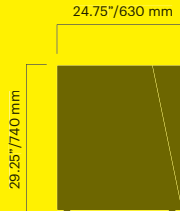
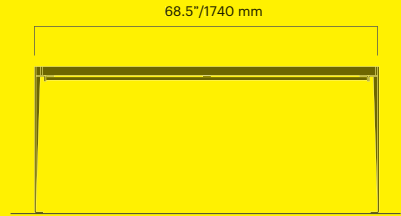

Bloc table add-on module

		kg CO ₂ e	MJ	lbs
Art. 1538-900	1 420 USD	166	2 697	158
Art. 1538-901	1 290 USD	166	2 697	159

Bloc table end module

Art. 1539-900	1 420 USD	158	2 575	152
Art. 1539-901	1 230 USD	158	2 575	152

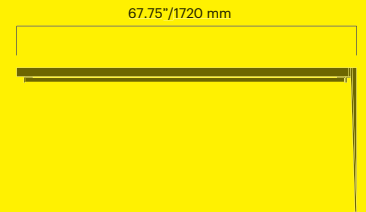
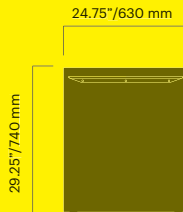
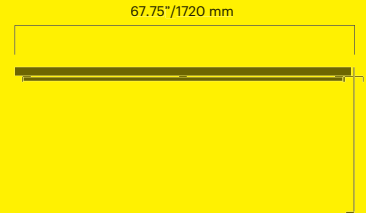

Bloc bar table

		kg CO ₂ e	MJ	lbs
Art. 1531-900	2 260 USD	359	5 500	225
Art. 1531-901	1 920 USD	359	5 500	225

* GWP & MJ proxy based on 1531-900

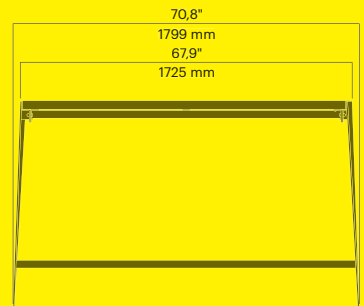
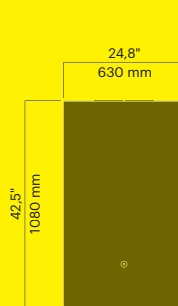

119 kg / 262.5 lb

Bloc litter receptacle

26 gallons

		kg CO ₂ e	MJ	lbs
Art. 1546-900	1 570 USD	164	2 290	113
Art. 1546-901	1 320 USD	164	2 290	113

For wall mounting

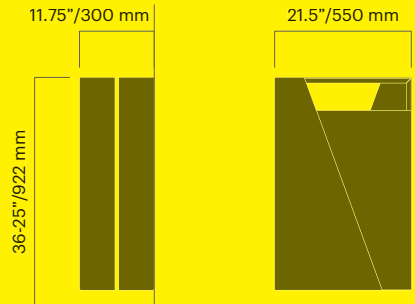

Bloc litter receptacle

26 gallons

		kg CO ₂ e	MJ	lbs
Art. 1542-900	1 700 USD	229	3 236	159
Art. 1542-901	1 480 USD	229	3 236	159

With ashtray

Art. 1543-900	1 940 USD	231	3 232	162
Art. 1543-901	1 690 USD	231	3 232	164

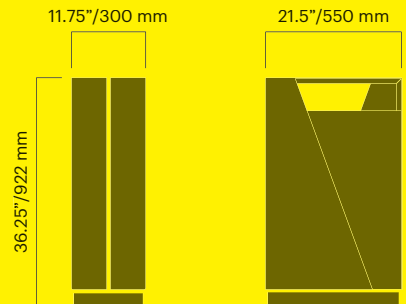

Bloc litter receptacle

36 gallons

		kg CO ₂ e	MJ	lbs
Art. 1544-900	2 360 USD	355	4 958	229
Art. 1544-901	2 110 USD	355	4 958	229

With ashtray

Art. 1545-900	2 700 USD	329	4 596	231
Art. 1545-901	2 400 USD	329	4 596	231

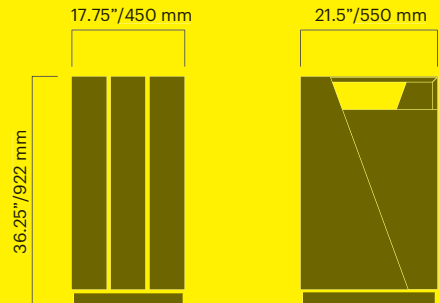

Bloc recycling

2 x 26,4		kg CO ₂ e	MJ	lbs
Art. 1548-900	3 060 USD	331	4 672	227
Art. 1548-901	2 610 USD	331	4 672	227
3 x 26,4				
Art. 1549-900	4 550 USD	497	7 019	339
Art. 1549-901	3 860 USD	497	7 019	339
2 x 26,4				
Art. 1548-900L	3 840 USD	353	4 982	240
Art. 1548-901L	3 380 USD	353	4 982	240
3 x 26,4				
Art. 1549-900L	5 690 USD	529	7 475	361
Art. 1549-901L	5 010 USD	529	7 475	361

* GWP & MJ proxy based on 1542-900

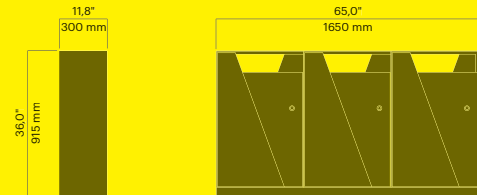
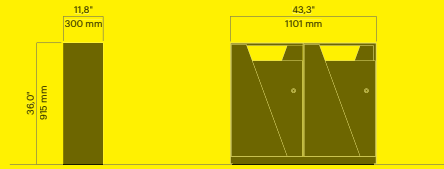

Bloc liner

		kg CO ₂ e	MJ	lbs
Art. 15991-901	330 USD	22	308	15
Art. 15992-901	390 USD	18	260	15

* GWP & MJ proxy based on 1542-900

Bloc planter

12 gallons		kg CO ₂ e	MJ	lbs
Art. 1581-900	1 200 USD	187	2 601	131
Art. 1581-901	1 030 USD	187	2 601	131
53 gallons				
Art. 1582-900	2 130 USD	408	5 677	285
Art. 1582-901	1 850 USD	408	5 677	285

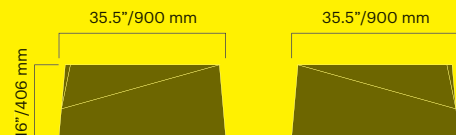
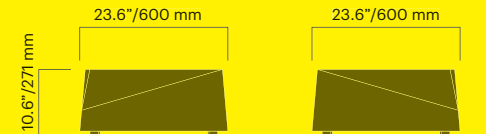

Bloc planter

137 gallons

		kg CO ₂ e	MJ	lbs
Art. 1583-900	3 430 USD	715	9 952	500
Art. 1583-901	2 910 USD	715	9 952	500

330 gallons

Art. 1584-900	4 830 USD	1193	16 618	836
Art. 1584-901	4 070 USD	1193	16 618	827

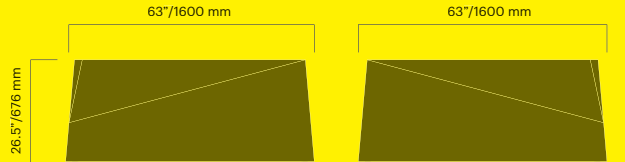
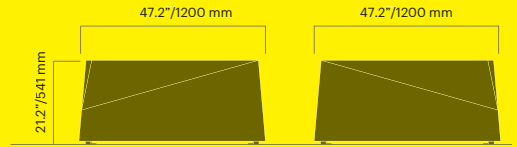

Boboli



Boboli planter

40 gallons

		kg CO ₂ e	MJ	lbs
Art. bob 065-070	1 030 USD	-	-	99
Art. bob 065-070RAL	1 030 USD	-	-	99

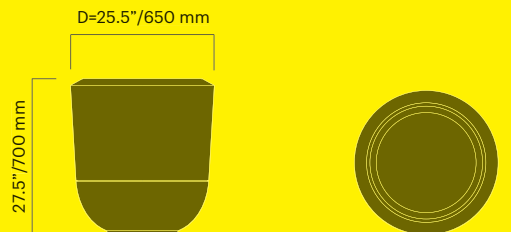

Boboli planter

45 gallons

Art. bob 090-038	1 080 USD	-	-	77
------------------	------------------	---	---	----

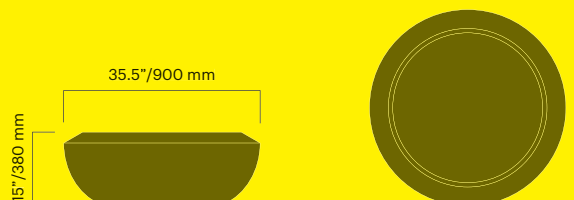

Boboli planter

100 gallons

Art. bob 090-070

1 580 USD

kg CO₂e

-

MJ

-

lbs

143

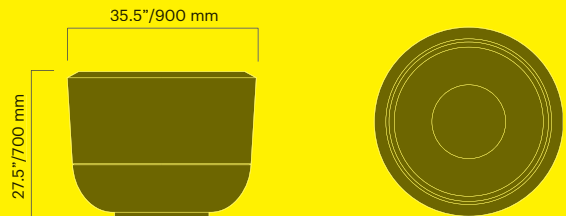

Boboli planter

132 gallons

Art. bob 090-090

1 700 USD

kg CO₂e

-

MJ

-

lbs

176

Art. bob 090-090RAL

1 700 USD

-

-

176

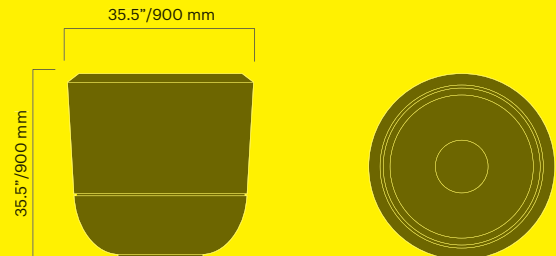

Boboli planter

148 gallons

Art. bob 120-070

2 070 USD

kg CO₂e

-

MJ

-

lbs

176



Boboli planter

201 gallons
 Art. bob 180-038 2 110 USD kg CO₂e MJ lbs
 - - 154

Irrigation system on request. Also available with drainage holes at no extra cost.

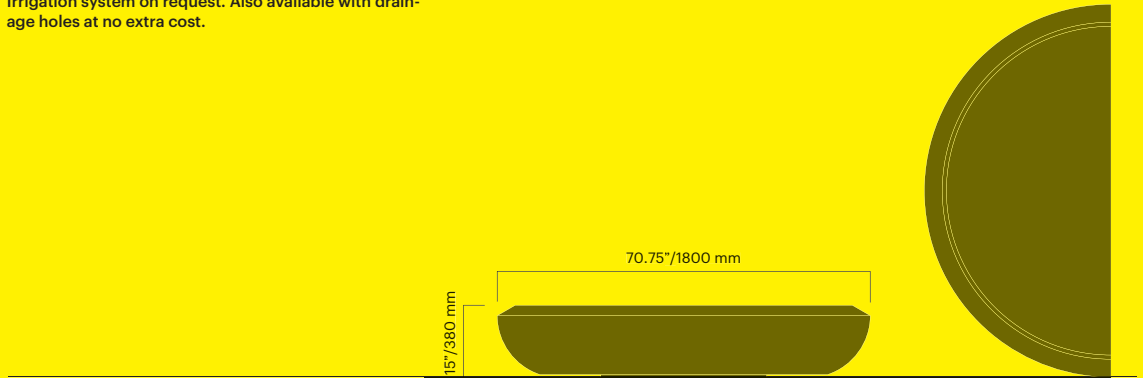

Boboli planter

201 gallons
 Art. bob 130-038 1 430 USD kg CO₂e MJ lbs
 - - 772

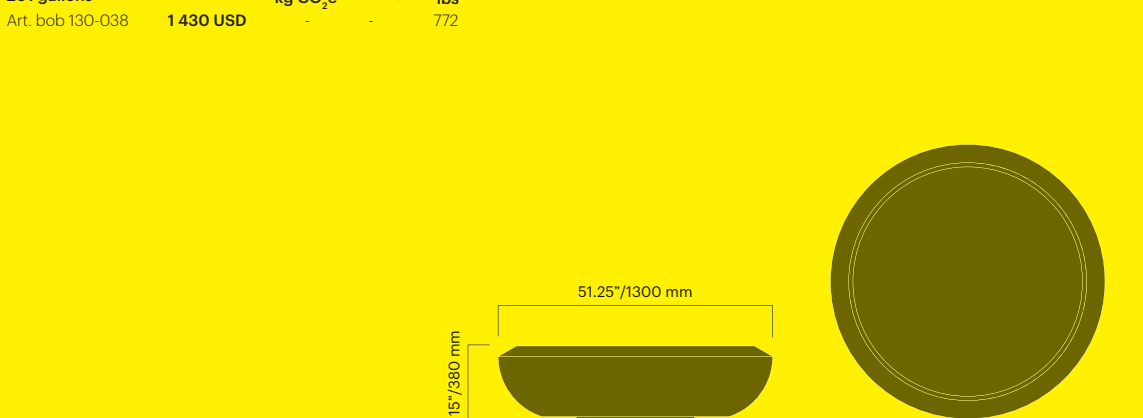

Bøy



Bøy bike rack

For 2 bikes
 Art. 388-900 360 USD kg CO₂e MJ lbs
 37 512 26
 Art. 388-901 290 USD 37 512 26

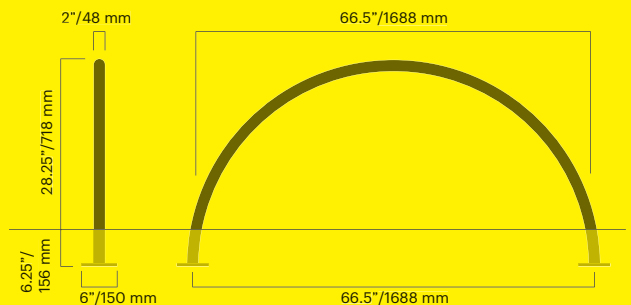



Briskeby backless bench

		kg CO ₂ e	MJ	lbs
Art. 6006-900	1 700 USD	139	2 252	135
Art. 6006-901	1 460 USD	139	2 252	134
Art. 6006-960	3 310 USD	139	2 252	128

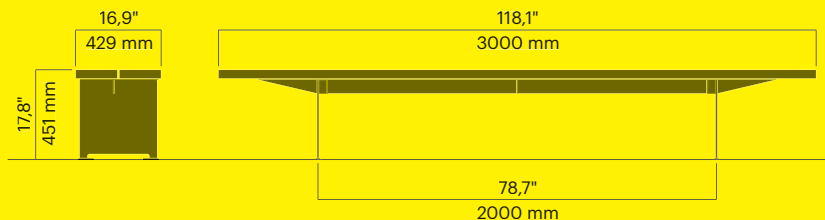

Briskeby backless bench with armrests

With armrests		kg CO ₂ e	MJ	lbs
Art. 6007-900	1 970 USD	139	2 252	141
Art. 6007-901	1 730 USD	150	2 404	141
Art. 6007-960	3 750 USD	150	2 404	141

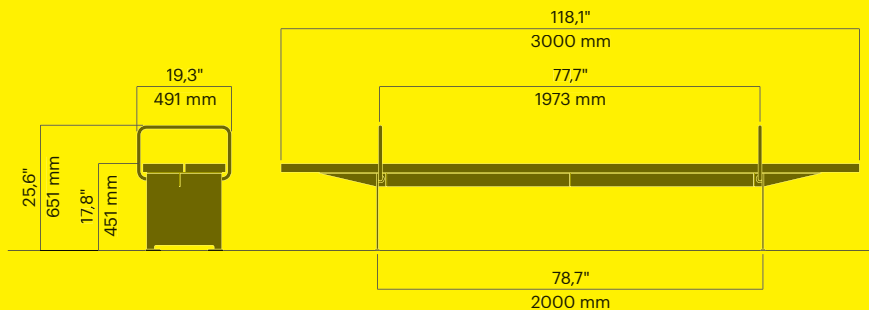

Briskeby short backed bench

		kg CO ₂ e	MJ	lbs
Art. 6013-900	1 930 USD	150	2 460	148
Art. 6013-901	1 700 USD	150	2 460	148
Art. 6013-960	3 770 USD	150	2 460	141

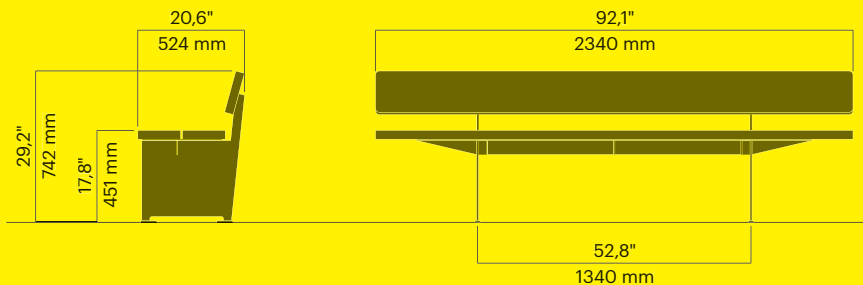

Briskeby backed bench

		kg CO ₂ e	MJ	lbs
Art. 6016-900	2 060 USD	163	2 737	172
Art. 6016-901	1 780 USD	163	2 737	172
Art. 6016-960	4 550 USD	163	2 737	172

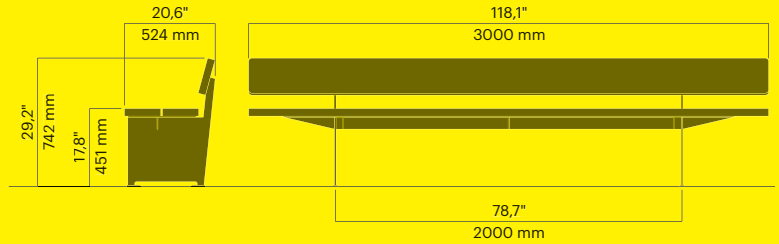

Briskeby backed bench with armrests

With armrests		kg CO ₂ e	MJ	lbs
Art. 6017-900	2 320 USD	189	3 123	183
Art. 6017-901	2 090 USD	189	3 123	183
Art. 6017-960	5 120 USD	189	3 123	161

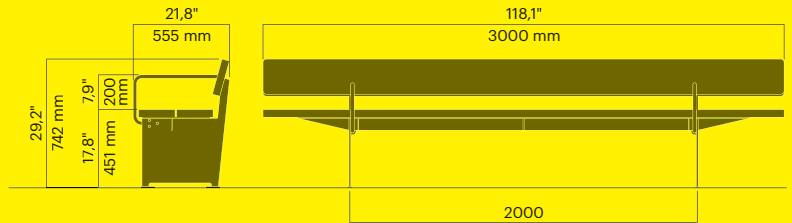

Buzz



Buzz picnic table

Table top and seats in high pressure laminate (HPL), with optional graphic printing (at additional cost)

		kg CO ₂ e	MJ	lbs
Art. 3316-900	3 360 USD	149	2 337	153
Art. 3316-901	2 870 USD	149	2 337	155

Table top in steel and seats in wood

Art. 3317-900	3 000 USD	244	3 489	179
Art. 3317-901	2 310 USD	244	3 489	179

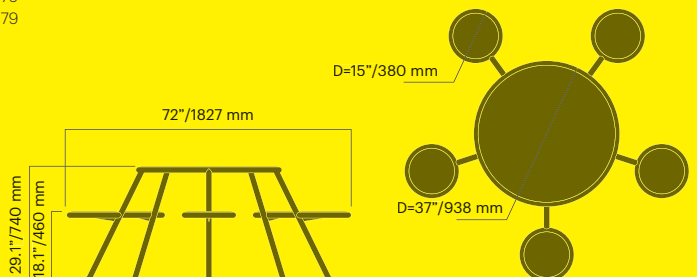

Buzz picnic table adapted for wheelchair

Table top and seats in high pressure laminate (HPL),
with optional graphic printing (at additional cost)

		kg CO ₂ e	MJ	lbs
Art. 3316-900H	3 000 USD	144	2 247	133
Art. 3316-901H	2 480 USD	144	2 247	132

Table top in steel and seats in wood

Art. 3317-900H	2 810 USD	223	3 171	162
Art. 3317-901H	2 120 USD	223	3 171	161

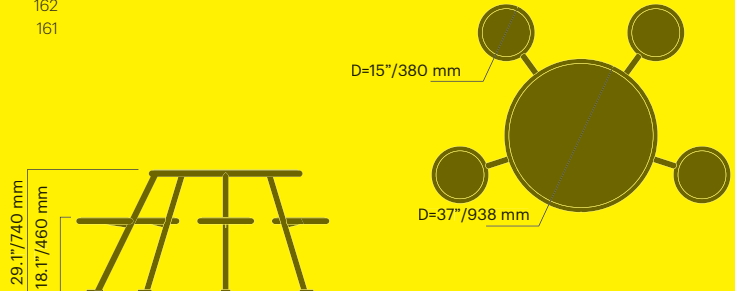

City



City litter receptacle

For mounting on a pole or wall
13 gallons

		kg CO ₂ e	MJ	lbs
With flat top				
Art. 241-900	990 USD	91	1 274	55
Art. 241-901	860 USD	91	1 274	53
With domed top				
Art. 251-900	1 170 USD	101	1 409	66
Art. 251-901	1 030 USD	101	1 409	68
With ashtray				
Art. 259-900	1 400 USD	102	1 428	64
Art. 259-901	1 220 USD	102	1 428	64

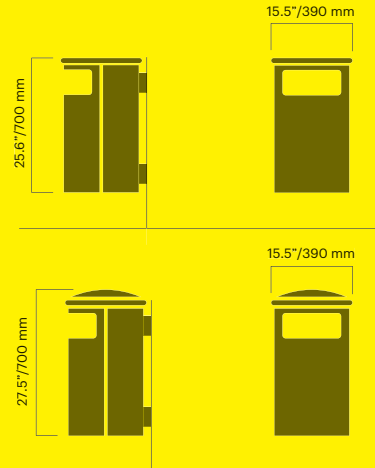

City litter receptacle split opening

13 gallons

		kg CO ₂ e	MJ	lbs
With flat top				
Art. 244-900	1 040 USD	98	1 366	55
Art. 244-901	700 USD	98	1 366	55
With domed top				
Art. 254-900	1 190 USD	99	1 387	62
Art. 254-901	1 040 USD	99	1 387	62
With ashtray				
Art. 255-900	1 410 USD	98	1 366	64
Art. 255-901	1 010 USD	98	1 366	64

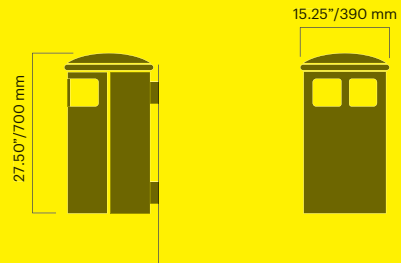

City mounting pole

Anchoring A or C		kg CO ₂ e	MJ	lbs
Art. 292-900A	240 USD	25	352	20
Art. 292-901A	210 USD	25	352	18
Art. 292-900C	230 USD	29	399	21
Art. 292-901C	180 USD	29	399	18
Pole D=76/60				
Art. 293-900	240 USD	25	344	24
Art. 293-901	210 USD	25	344	24

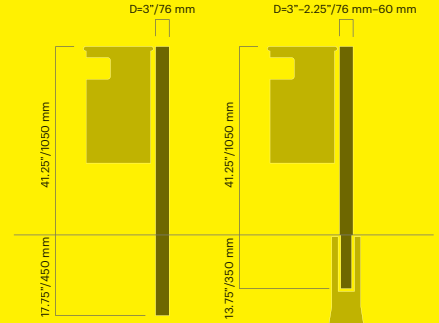

City fasteners

For 5" pole D 127		kg CO ₂ e	MJ	lbs
Art. 290-900	140 USD	7	94	7
Art. 290-901	100 USD	7	94	7
For 4" pole D 101				
Art. 291-900	140 USD	7	99	5
Art. 291-901	100 USD	7	99	5

Set



City litter receptacle

18 gallons

With flat top		kg CO ₂ e	MJ	lbs
Art. 242-900	1 110 USD	106	1 474	71
Art. 242-901	980 USD	106	1 474	71
With domed top				
Art. 252-900	1 600 USD	115	1 605	77
Art. 252-901	1 410 USD	115	1 605	77
With ashtray				
Art. 243-900	1 360 USD	119	1 658	79
Art. 243-901	1 080 USD	119	1 658	79

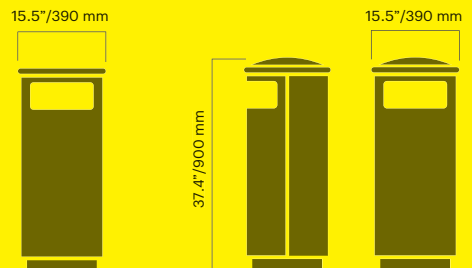

City litter receptacle

48 gallons

		kg CO ₂ e	MJ	lbs
With flat top				
Art. 247-900	1 340 USD	139	1 931	108
Art. 247-901	1 160 USD	139	1 931	108
With domed top				
Art. 257-900	1 580 USD	132	1 920	117
Art. 257-901	1 400 USD	132	1 920	119
With ashtray				
Art. 261-900	1 800 USD	132	1 920	119
Art. 261-901	1 630 USD	132	1 920	130

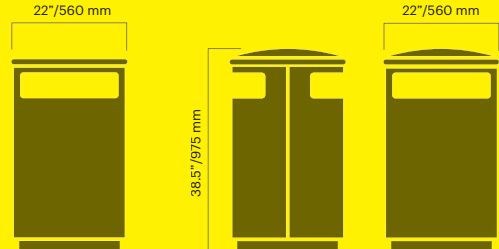

City litter receptacle split opening

40 gallons

		kg CO ₂ e	MJ	lbs
With domed top				
Art. 277-900	1 560 USD	159	2 214	119
Art. 277-901	1 370 USD	159	2 214	117
With ashtray				
Art. 278-900	1 850 USD	164	2 290	121
Art. 278-901	1 460 USD	164	2 290	121
With recycling for empty bottles				
Art. 279-900	1 420 USD	178	2 477	128
Art. 279-901	1 250 USD	178	2 477	128
With ashtray and recycling for empty bottles				
Art. 280-900	1 850 USD	183	2 552	130
Art. 280-901	1 660 USD	183	2 552	130

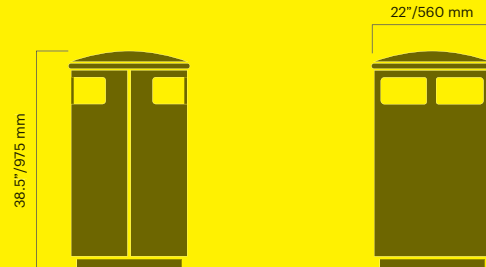

City litter receptacle

48 gallons

		kg CO ₂ e	MJ	lbs
With flat top				
Art. 248-900	1 380 USD	157	2 184	121
Art. 248-901	1 200 USD	157	2 184	118
With domed top				
Art. 258-900	1 620 USD	176	2 453	134
Art. 258-901	1 430 USD	176	2 453	134
With ashtray				
Art. 262-900	1 870 USD	181	2 521	134
Art. 262-901	1 680 USD	181	2 521	137

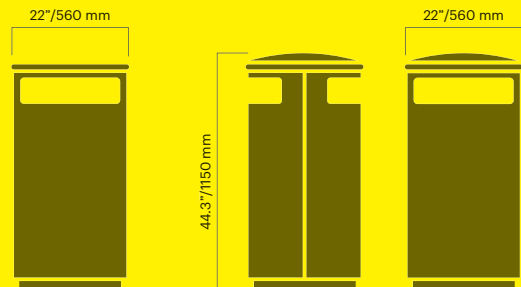

City litter receptacle split opening

With flat top		kg CO ₂ e	MJ	lbs
Art. 276-900	1 430 USD	177	2 472	121
Art. 276-901	920 USD	177	2 472	121
With domed top				
Art. 275-900	1 670 USD	177	2 472	134
Art. 275-901	1 160 USD	177	2 472	134
With ashtray				
Art. 274-900	1 890 USD	182	2 535	134
Art. 274-901	1 720 USD	182	2 535	121

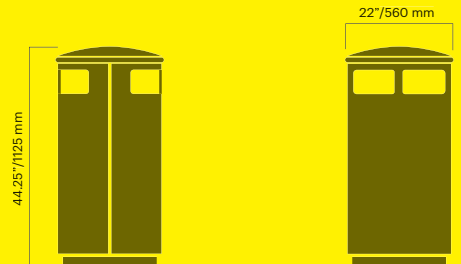

City recycling receptacle for empty bottles

48 gallons

With flat top		kg CO ₂ e	MJ	lbs
Art. 270-900	1 910 USD	194	2 704	126
Art. 270-901	1 710 USD	194	2 704	126
With domed top				
Art. 272-900	2 090 USD	194	2 704	139
Art. 272-901	1 780 USD	194	2 704	139
With ashtray				
Art. 271-900	2 290 USD	194	2 704	143
Art. 271-901	2 130 USD	194	2 704	143

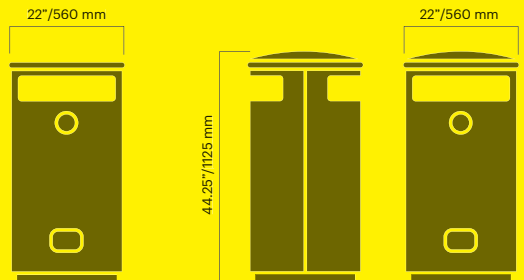

City ashtray

Wall-mounted		kg CO ₂ e	MJ	lbs
Art. 265-900	420 USD	18	253	11
Art. 265-901	390 USD	18	253	11
For mounting pole				
Art. 266-900	430 USD	20	286	13
Art. 266-901	420 USD	20	286	13

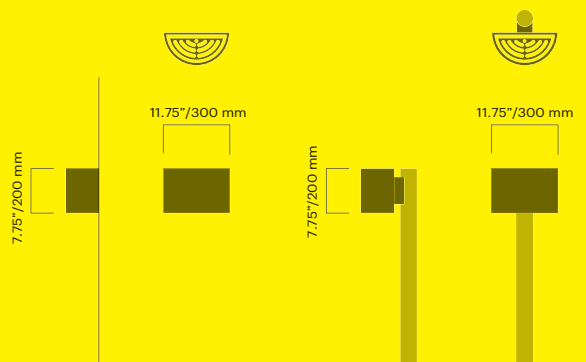

City ashtray

With domed top and receptable 4 gallons

H: 630		kg CO ₂ e	MJ	lbs
Art. 263-900	1 020 USD	121	1 346	62
Art. 263-901	910 USD	121	1 346	82
H: 930		kg CO ₂ e	MJ	lbs
Art. 264-900	1 150 USD	152	1 766	99
Art. 264-901	1 030 USD	152	1 766	99

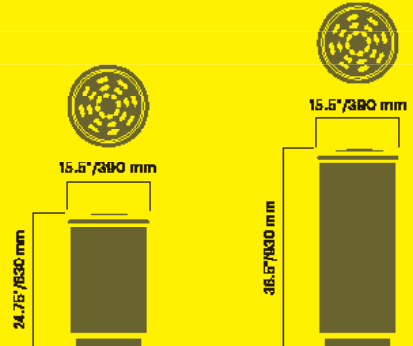

City ashtray

With flat top 16 gallons

With flat top 16 gallons		kg CO ₂ e	MJ	lbs
Art. 267-900	1 090 USD	82	1 190	71
Art. 267-901	980 USD	82	1 190	71

With flat top 32 gallons

Art. 268-900	1 250 USD	109	1 601	62
Art. 268-901	1 160 USD	109	1 601	77

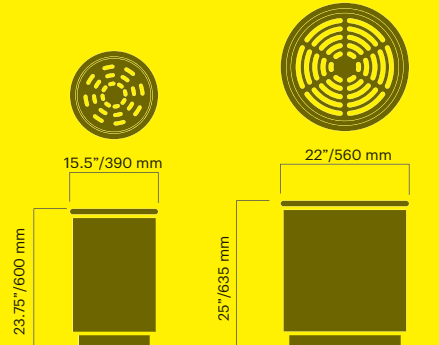

City bike bollard

Complete with foundation

For 2 bikes		kg CO ₂ e	MJ	lbs
Art. 286-800	560 USD	82	1 270	44

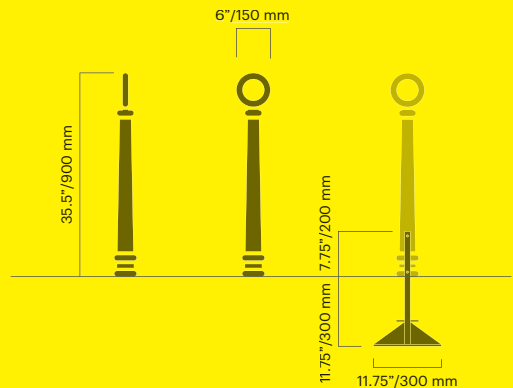



Coast backless backed bench made of recycled ownerless marine plastic

Rental model only. Pricing available on request	kg CO ₂ e	MJ	lbs
Art. 5506-530	-	-	-
Art. 5506-530	-	-	-
Model with wood seat			
Art. 5506-900 2 480 USD	193	2 973	165
Art. 5506-901 2 130 USD	193	2 973	165

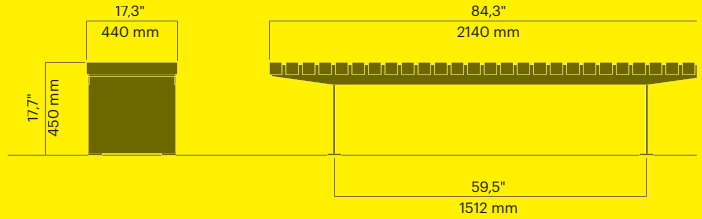

Code



Code module backless bench

Complete basic module	kg CO ₂ e	MJ	lbs
Art. 2616-900 1 500 USD	137	2 226	132
Art. 2616-901 1 340 USD	137	2 226	130
Base module, without wood			
Art. 2617-900 780 USD	100	1 393	69
Art. 2617-901 620 USD	100	1 393	69
Wooden seat			
Art. 2620-900 580 USD	20	492	37
Art. 2620-901 550 USD	20	492	37
Wooden front			
Art. 2624-900 390 USD	17	349	12
Art. 2624-901 360 USD	17	349	13
Armrest			
Art. 2628-900 540 USD	42	586	29
Art. 2628-901 490 USD	42	586	29

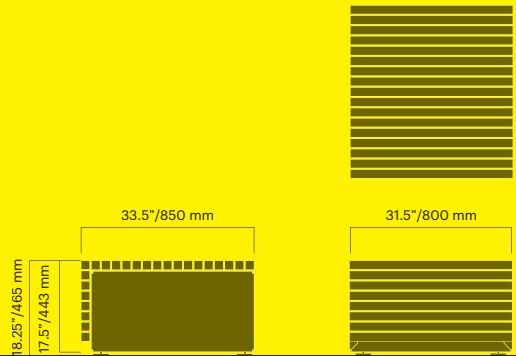

Code planter

66 gallons

		kg CO ₂ e	MJ	lbs
Art. 2640-900	1 430 USD	182	2 530	149
Art. 2640-901	1 240 USD	182	2 530	128

132 gallons

Art. 2646-900	1 850 USD	285	3 975	224
Art. 2646-901	1 620 USD	285	3 975	203

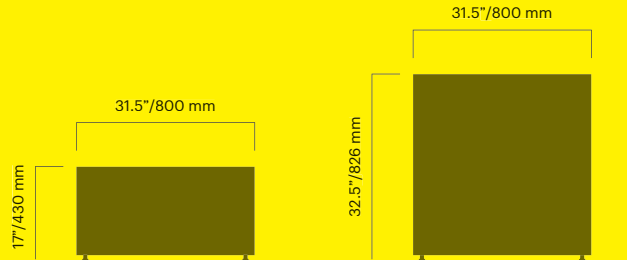

Corner



Corner backless bench for wall top

		kg CO ₂ e	MJ	lbs
Art. 4103-900MK	1 490 USD	79	1 384	86
Art. 4103-901MK	1 370 USD	79	1 384	86

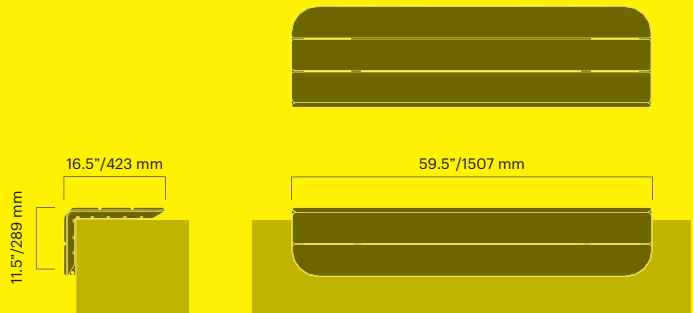

Corner single backless bench for wall top

		kg CO ₂ e	MJ	lbs
Art. 4104-900MK	1 230 USD	37	585	33
Art. 4104-901MK	1 120 USD	37	585	33

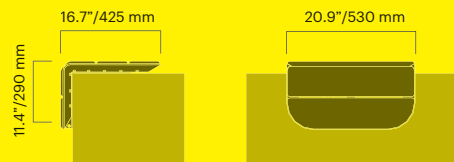

Cover



Cover roof

With steel

		kg CO ₂ e	MJ	lbs
Art. 4701-900A	13 900 USD	1945	27 166	1362
Art. 4701-901A	12 290 USD	1945	27 166	1362

With glass

Art. 4702-900A	14 500 USD	1446	21 065	1286
Art. 4702-901A	13 470 USD	1446	21 065	1286

With sedum

Art. 4703-900A	14 500 USD	1880	29 113	1385
Art. 4703-901A	13 800 USD	1880	29 113	1385

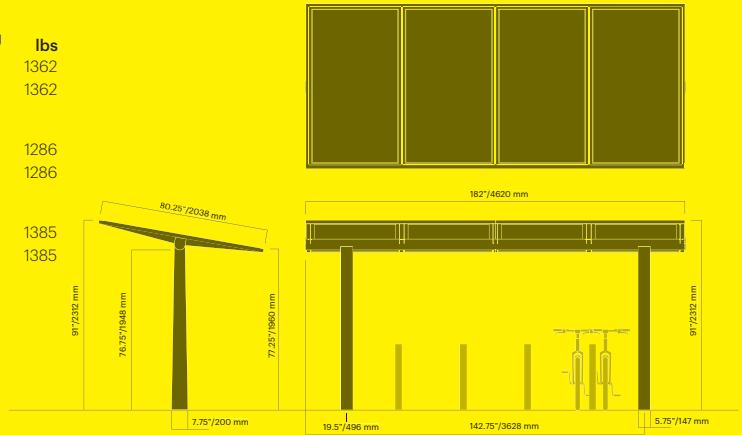

Cycle



Cycle bike rack for 2 bikes

Anchoring with base plate

		kg CO ₂ e	MJ	lbs
Art. 4886-900A	600 USD	52	718	36
Art. 4886-901A	940 USD	52	718	36

Concreting in place

Art. 4886-900C	950 USD	47	657	32
Art. 4886-901C	920 USD	47	657	35

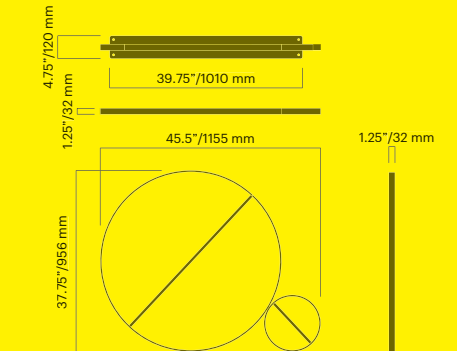

Dialog



Dialog backless bench

Kebony Clear		kg CO ₂ e	MJ	lbs
Art. 1406-932	3 730 USD	29	884	77
Oak				
Art. 1406-942	3 730 USD	21	1 115	77

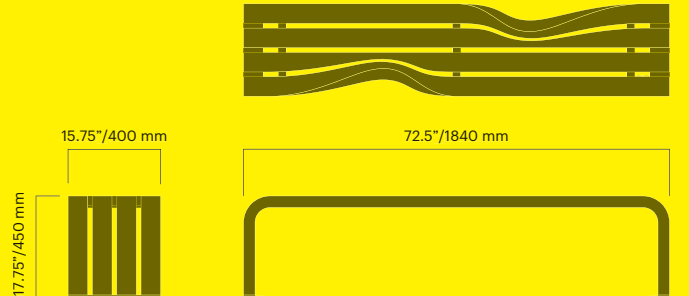

Dialog litter receptacle

26 gallons		kg CO ₂ e	MJ	lbs
Art. 1442-900	1 730 USD	178	2 444	186
Art. 1442-901	1 520 USD	178	2 444	186

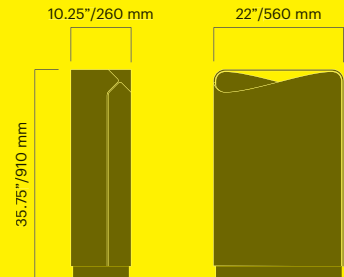

Dialog recycling receptacle

3 x 15 gallons		kg CO ₂ e	MJ	lbs
Art. 1448-900	2 810 USD	282	3 932	197
Art. 1448-901	2 570 USD	282	3 932	197
3 x 24 gallons				
Art. 1444-900	2 810 USD	113	1 579	231
Art. 1444-901	2 570 USD	113	1 579	231

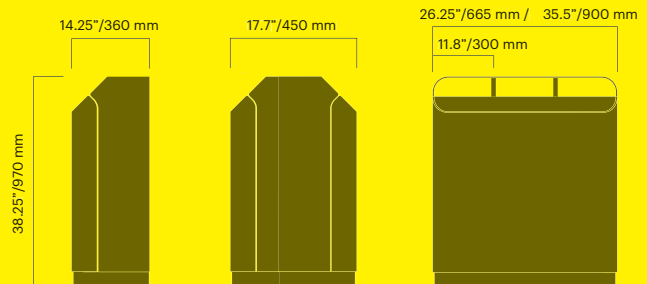



Edo backless bench with marble table

Kebony, oak and ash		kg CO ₂ e	MJ	lbs
Art. 4308-930	3 110 USD	55	1 383	66
Art. 4308-940	3 110 USD	18	1 076	66
Art. 4308-950	3 110 USD	18	1 076	66

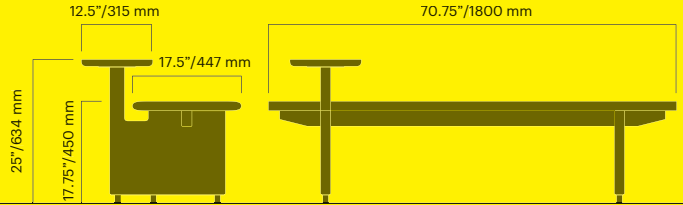

Edo solid wood backed bench

Kebony, oak and ash		kg CO ₂ e	MJ	lbs
Art. 4316-930	3 730 USD	57	1 427	88
Art. 4316-940	3 730 USD	14	1 079	88
Art. 4316-950	3 730 USD	14	1 079	88

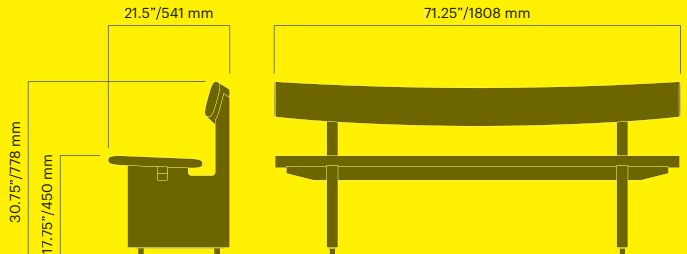

Edo backed bench with steel frame

		kg CO ₂ e	MJ	lbs
Art. 4315-930	3 020 USD	155	2 834	152
Art. 4315-931	2 860 USD	155	2 834	152

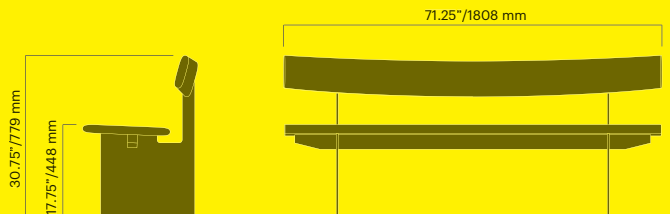



Folk backless bench with armrests

Concreting in place		kg CO ₂ e	MJ	lbs
Art. 4904-904C	1 200 USD	50	983	55
Anchoring with base plate				
Art. 4904-904A	1 350 USD	61	1168	59
Free-standing				
Art. 4904-904	1 480 USD	41	839	50

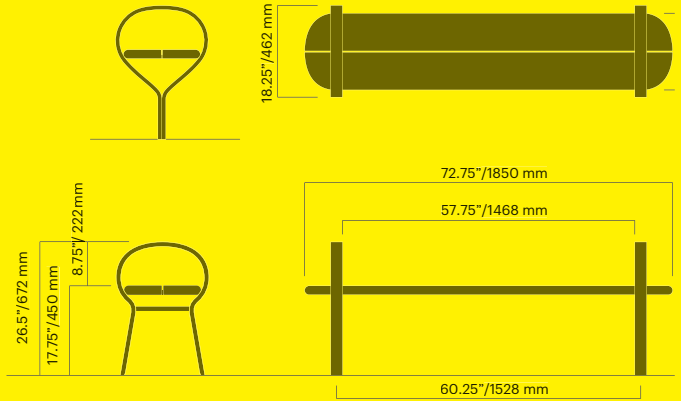

Folk backed bench with armrests

Concreting in place		kg CO ₂ e	MJ	lbs
Art. 4914-904C	1 430 USD	67	1347	72
Anchoring with base plate				
Art. 4914-904A	1 740 USD	77	1521	84
Free-standing				
Art. 4914-904	1 620 USD	52	1095	67

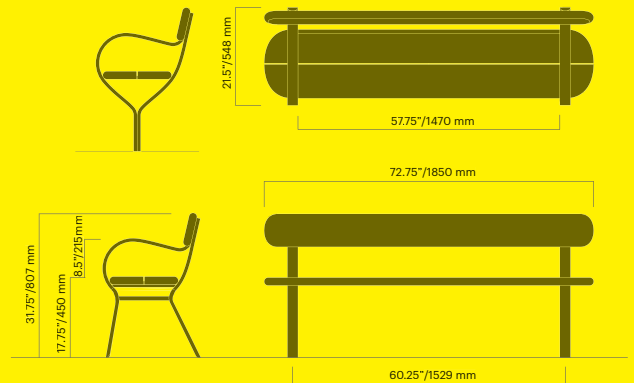

Folk table

Concreting in place		kg CO ₂ e	MJ	lbs
Art. 4933-904C	1 400 USD	96	1908	86
Anchoring with base plate				
Art. 4933-904A	1 620 USD	108	2104	87
Free-standing				
Art. 4933-904	1 620 USD	54	1201	76

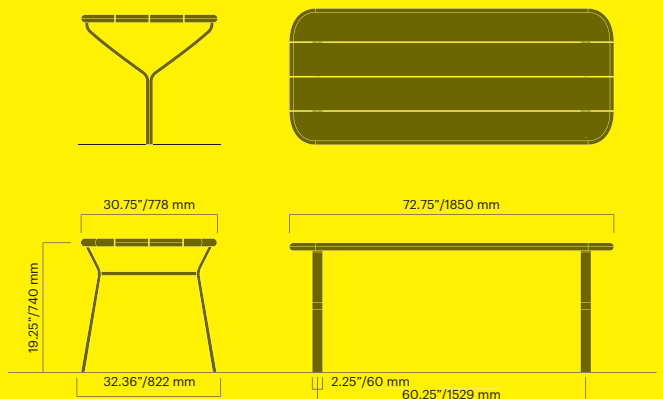

Folk litter receptacle

Flat top, concreting in place

Art. 4942-904C **1 480 USD** kg CO₂e MJ lbs
134 1944 66

Flat top, anchoring with base plate

Art. 4942-904A **1 610 USD** 134 1944 66

Oblique top, concreting in place

Art. 4943-904C **1 490 USD** 106 1568 64

Oblique top, anchoring with base plate

Art. 4943-904A **1 610 USD** 106 1568 65

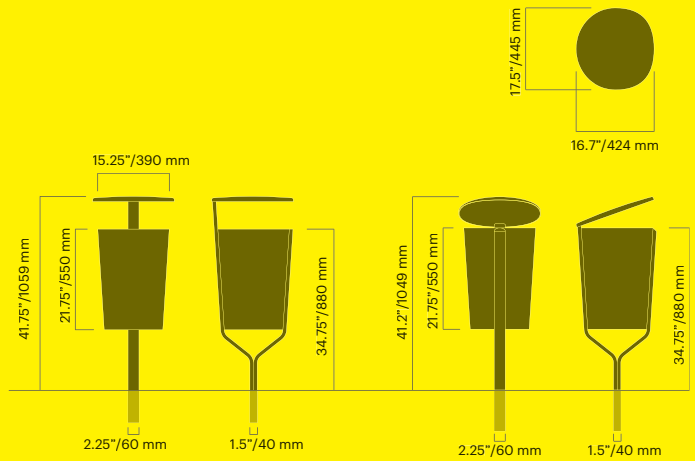

Folk litter receptacle

Free-standing

Art. 4944-904 **1 980 USD** kg CO₂e MJ lbs
212 3 039 149

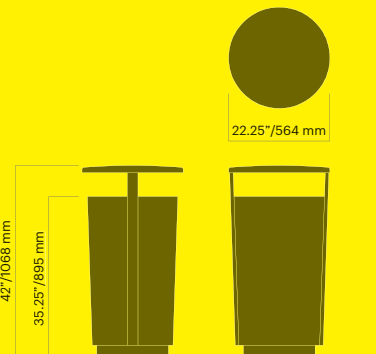

Folk bike rack

Small, concreting in place

Art. 4987-904C **330 USD** kg CO₂e MJ lbs
22 371 16

Small, anchoring with base plate

Art. 4987-904A **430 USD** 28 469 17

Large, anchoring with base plate

Art. 4986-904A **440 USD** 28 464 20

Large, concreting in place

Art. 4986-904C **340 USD** 22 371 17

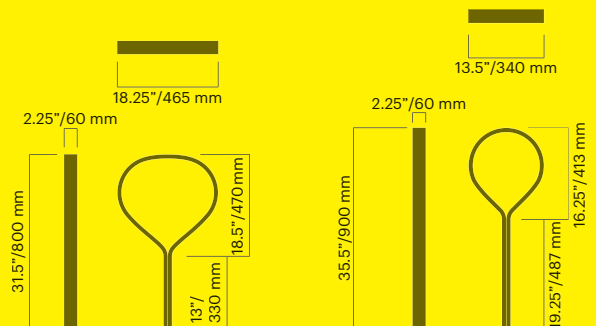



Forum backless bench

Anchoring A or C

		kg CO ₂ e	MJ	lbs
Art. 2502-900A	1 280 USD	120	1 831	101
Art. 2502-901A	1 120 USD	120	1 831	101
Art. 2502-900C	1 230 USD	132	1 996	110
Art. 2502-901C	1 060 USD	132	1 996	110

Free-standing

Art. 2502-900	1 520 USD	150	2 249	123
Art. 2502-901	1 400 USD	150	2 249	123

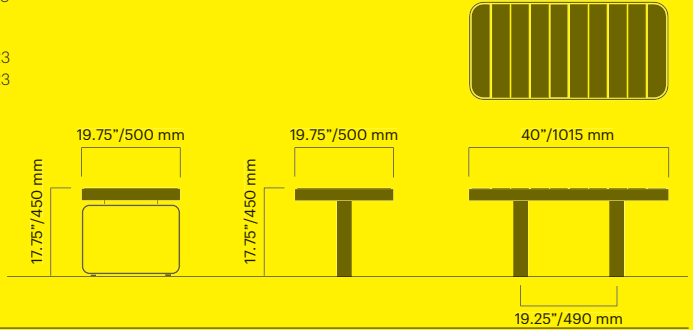

Forum backless bench

Anchoring A or C

		kg CO ₂ e	MJ	lbs
Art. 2503-900A	1 900 USD	196	3 056	150
Art. 2503-901A	1 680 USD	196	3 056	150
Art. 2503-900C	1 850 USD	177	2 793	159
Art. 2503-901C	1 620 USD	177	2 793	159

Free-standing

Art. 2503-900	2 280 USD	196	3 056	172
Art. 2503-901	1 990 USD	196	3 056	172

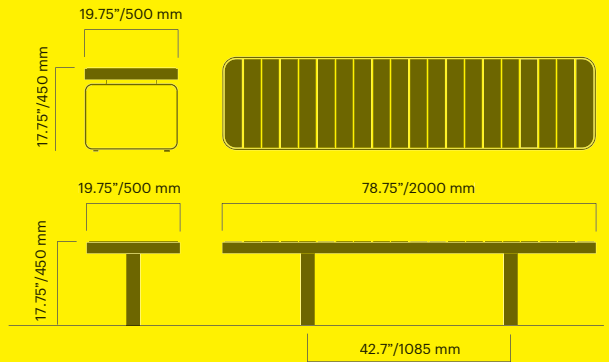

Forum backless bench

Anchoring A or C

		kg CO ₂ e	MJ	lbs
Art. 2504-900A	2 490 USD	215	3 497	205
Art. 2504-901A	2 080 USD	215	3 497	205
Art. 2504-900C	2 450 USD	227	3 666	214
Art. 2504-901C	2 020 USD	227	3 666	214

Free-standing

Art. 2504-900	2 810 USD	246	3 929	227
Art. 2504-901	2 480 USD	246	3 929	227

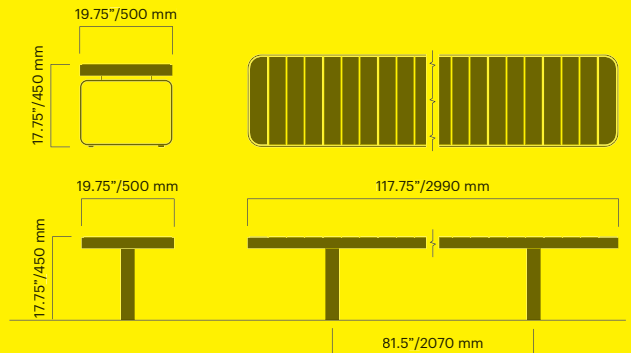

Forum armrests and back

Backrest for 2 and 3 meter bench		kg CO ₂ e	MJ	lbs
Art. 2522-900	710 USD	31	498	29
Art. 2522-901	550 USD	31	498	26
Armrest				
Art. 2525-900	190 USD	10	133	7
Art. 2525-901	160 USD	10	133	7

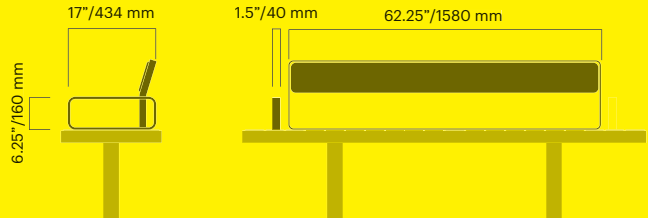

Forum table

38,4"

Free-standing		kg CO ₂ e	MJ	lbs
Art. 2532-900	1 610 USD	173	2 571	139
Art. 2532-901	1 480 USD	173	2 571	137

Anchoring A or C

Art. 2532-900A	1 320 USD	135	2 041	112
Art. 2532-901A	1 160 USD	135	2 041	112
Art. 2532-900C	1 240 USD	146	2 200	121
Art. 2532-901C	1 060 USD	146	2 200	121

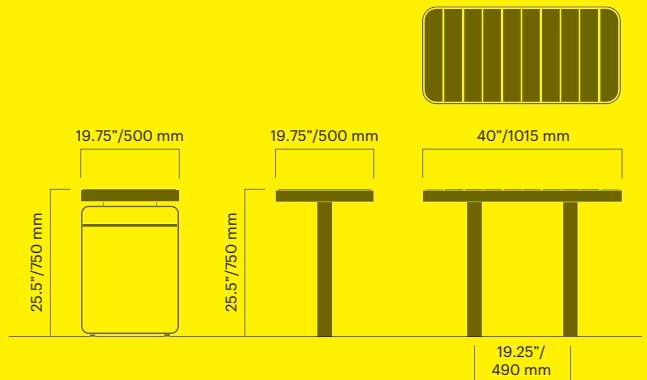

Forum table

78,7"

Free-standing		kg CO ₂ e	MJ	lbs
Art. 2533-900	2 480 USD	221	3 413	190
Art. 2533-901	2 230 USD	221	3 413	192

Anchoring A or C

Art. 2533-900A	2 110 USD	180	2 841	161
Art. 2533-901A	1 740 USD	180	2 841	161
Art. 2533-900C	2 030 USD	204	3 174	170
Art. 2533-901C	1 700 USD	204	3 174	170

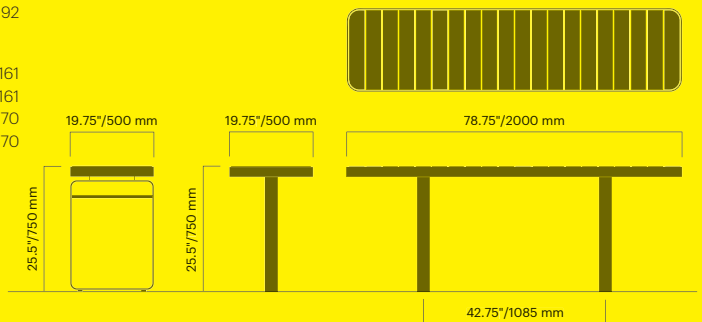

Forum table

118 "

Free-standing, W500

		kg CO ₂ e	MJ	lbs
Art. 2534-900	3 060 USD	267	4 213	245
Art. 2534-901	2 610 USD	267	4 213	247

Free-standing, W750

Art. 2536-900	3 750 USD	387	6 135	265
Art. 2536-901	3 070 USD	387	6 135	265

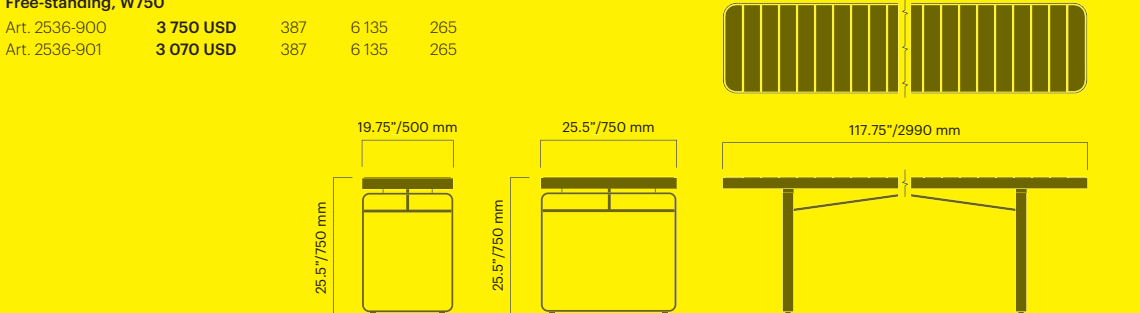

Forum table

Anchoring A or C, W500

		kg CO ₂ e	MJ	lbs
Art. 2534-900A	2 540 USD	230	3 708	216
Art. 2534-901A	2 230 USD	230	3 708	216
Art. 2534-900C	2 460 USD	242	3 868	225
Art. 2534-901C	2 130 USD	242	3 868	225

Anchoring A or C, W750

Art. 2536-900A	3 200 USD	272	4 531	175
Art. 2536-901A	2 960 USD	272	4 531	175
Art. 2536-900C	3 170 USD	269	4 493	173
Art. 2536-901C	2 870 USD	269	4 493	173

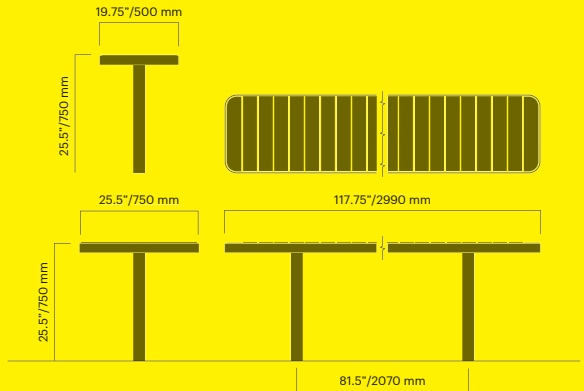

Forum litter receptacle

34 gallons

		kg CO ₂ e	MJ	lbs
Art. 2542-900	2 120 USD	180	2 475	188
Art. 2542-901	1 780 USD	180	2 475	188
Art. 2543-900	2 120 USD	183	2 521	191
Art. 2543-901	1 780 USD	183	2 521	191
Art. 2544-900	2 120 USD	174	2 394	188
Art. 2544-901	1 780 USD	174	2 394	188
Art. 2545-900	2 120 USD	175	2 404	186
Art. 2545-901	1 780 USD	175	2 404	186

With opening from the side

Art. 2546-900	2 120 USD	203	2 802	208
Art. 2546-901	1 780 USD	203	2 802	208

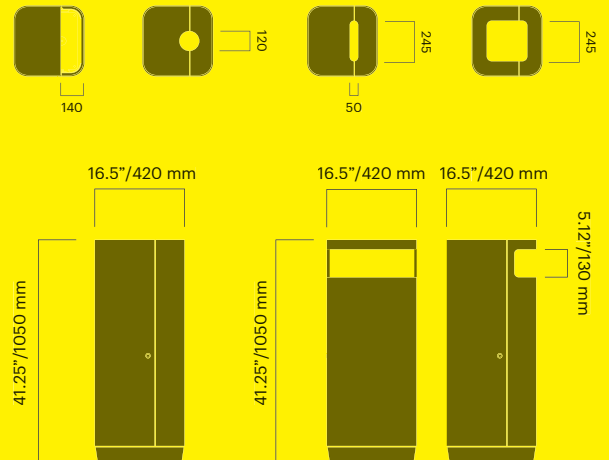

Forum bike rack for 2 bikes

Anchoring A or C

		kg CO ₂ e	MJ	lbs
Small				
Art. 2584-904A	440 USD	18	309	22
Art. 2584-904C	410 USD	21	361	11
Large				
Art. 2586-904A	580 USD	28	464	20
Art. 2586-904C	440 USD	21	361	28

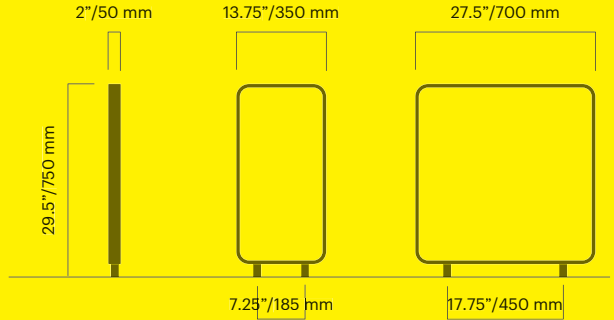

Hill



Hill litter receptacle

		kg CO ₂ e	MJ	lbs
Split-stream				
Art. 6342-900	1 930 USD	203	2 828	142
Art. 6342-901	1 700 USD	203	2 828	139
Single-stream				
Art. 6344-900	1 830 USD	200	2 793	141
Art. 6344-901	1 590 USD	200	2 793	138

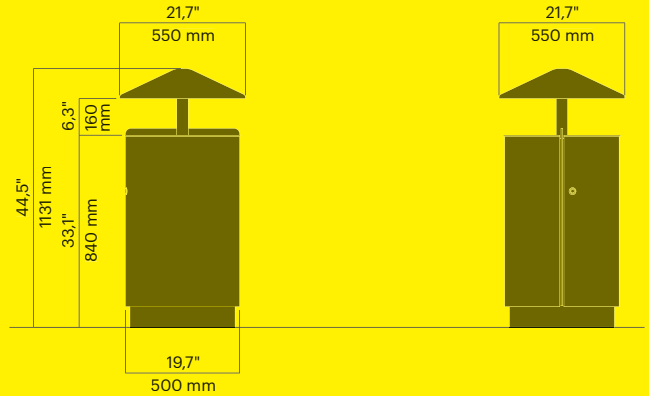

Hvilan



Hvilan backless bench

		kg CO ₂ e	MJ	lbs
Art. 106-900	990 USD	107	1 680	97
Art. 106-901	850 USD	107	1 680	95

Option: Extended legs for concreting in place		kg CO ₂ e	MJ	lbs
Art. 101-901	70 USD	5	71	4

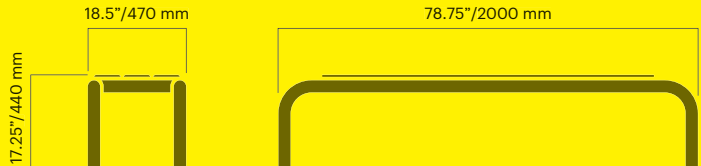

Hvilan backed bench

		kg CO ₂ e	MJ	lbs
Art. 116-900	1 600 USD	140	2 284	130
Art. 116-901	1 260 USD	140	2 284	130

Option: Extended legs for concreting in place		kg CO ₂ e	MJ	lbs
Art. 101-901	70 USD	5	71	4

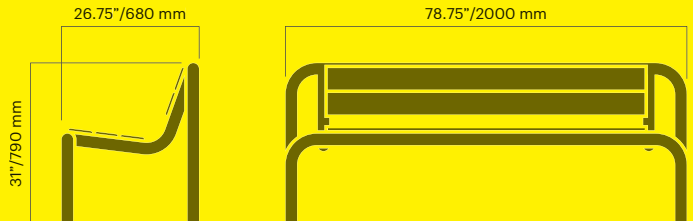

Hvilan table

		kg CO ₂ e	MJ	lbs
Art. 133-900	1 340 USD	134	2 194	130
Art. 133-901	1 140 USD	134	2 194	130

Option: Extended legs for concreting in place		kg CO ₂ e	MJ	lbs
Art. 101-901	70 USD	5	71	4

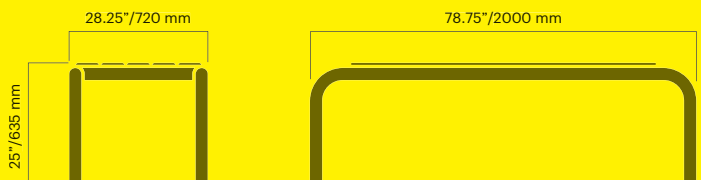

Hvilan picnic table

		kg CO ₂ e	MJ	lbs
Art. 122-900	2 050 USD	161	2 868	153
Art. 122-901	1 940 USD	161	2 868	153

Adapted for wheelchair

Art. 122-900HC	2 170 USD	140	2 754	167
Art. 122-901HC	1 980 USD	140	2 754	167



Hvilan tree barrier

D900

		kg CO ₂ e	MJ	lbs
Art. 153-900	1 040 USD	129	1 797	95
Art. 153-901	800 USD	129	1 797	95

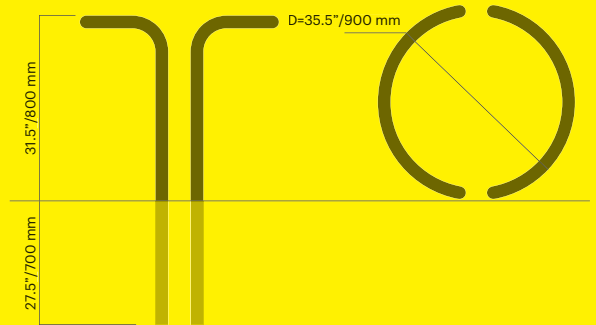

Hvilan bollard

Model A and C are dimensioned to stop 3.5 tons at 18 mph

Anchoring A		kg CO ₂ e	MJ	lbs
Art. 185-900A	1 350 USD	154	2 149	176
Art. 185-901A	1 240 USD	154	2 149	176

Anchoring C		kg CO ₂ e	MJ	lbs
Art. 185-900C	990 USD	154	2 149	137
Art. 185-901C	800 USD	154	2 149	137

Demountable		kg CO ₂ e	MJ	lbs
Art. 185-900D	1 360 USD	157	2 191	128
Art. 185-901D	1 240 USD	157	2 191	128

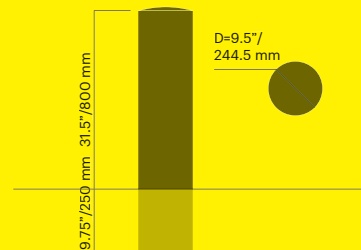



Kong cube

Free-standing

		kg CO ₂ e	MJ	lbs
Art. 4010-900	1 570 USD	74	1 336	84
Art. 4010-901	1 350 USD	74	1 336	84

Concreting in place

Art. 4010-900C	1 620 USD	88	1 529	95
Art. 4010-901C	1 400 USD	88	1 529	95

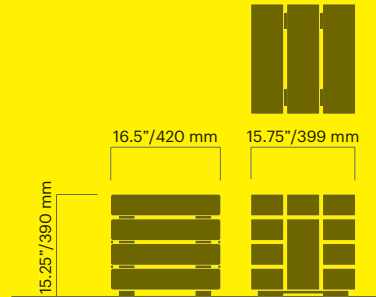

Kong backless bench

Anchoring A or C

		kg CO ₂ e	MJ	lbs
Art. 4003-900A	2 130 USD	166	3 289	225
Art. 4003-901A	1 850 USD	166	3 289	225
Art. 4003-900C	2 230 USD	203	3 797	251
Art. 4003-901C	1 900 USD	203	3 797	251

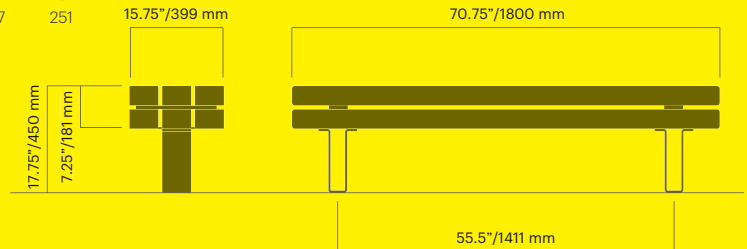

Kong backrest

		kg CO ₂ e	MJ	lbs
Art. 4021-900	970 USD	50	888	56
Art. 4021-901	900 USD	50	888	56

Armrest

		kg CO ₂ e	MJ	lbs
Art. 4025-900	260 USD	16	229	11
Art. 4025-901	240 USD	16	229	11

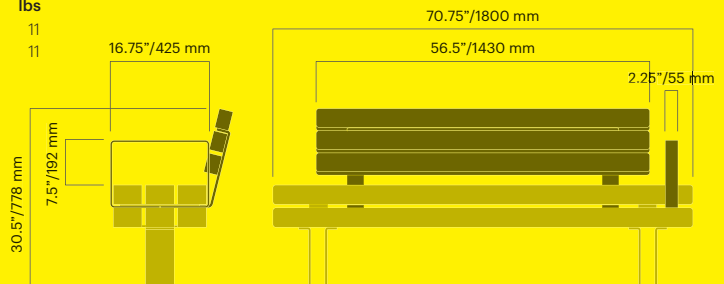

Kong sun bench

Anchoring A or C		kg CO ₂ e	MJ	lbs
Art. 4066-900A	4 990 USD	335	5 662	359
Art. 4066-901A	4 720 USD	335	5 662	359
Art. 4066-900C	4 990 USD	407	6 661	402
Art. 4066-901C	4 720 USD	407	6 661	402

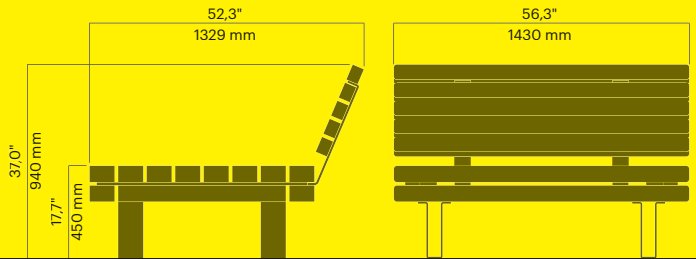

Kong table

Anchoring A or C		kg CO ₂ e	MJ	lbs
Art. 4033-900A	2 310 USD	340	5 128	276
Art. 4033-901A	2 080 USD	340	5 128	276
Art. 4033-900C	2 460 USD	396	5 898	317
Art. 4033-901C	2 200 USD	396	5 898	317

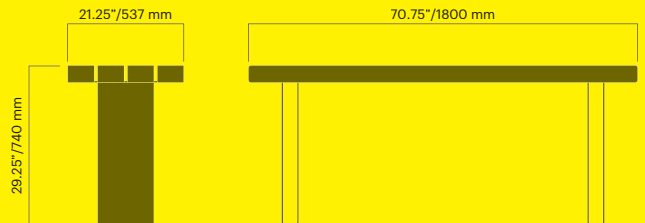

Kyoto



Kyoto backless bench

		kg CO ₂ e	MJ	lbs
Art. 2206-004	2 110 USD	39	1 399	364

Armrest pair for bench

Art. 2226-900	490 USD	16	221	11
Art. 2226-901	430 USD	16	221	11

Bolting to the ground recommended

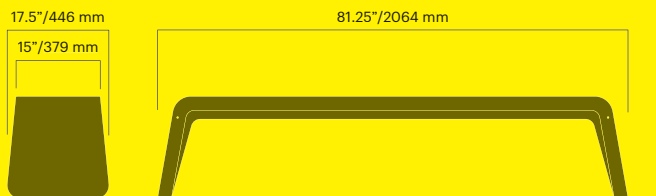

Kyoto backed bench

		kg CO ₂ e	MJ	lbs
Art. 2216-004	2 990 USD	72	2 586	672

Armrest pair for bench

Art. 2225-900	490 USD	16	221	42
Art. 2225-901	430 USD	16	221	11

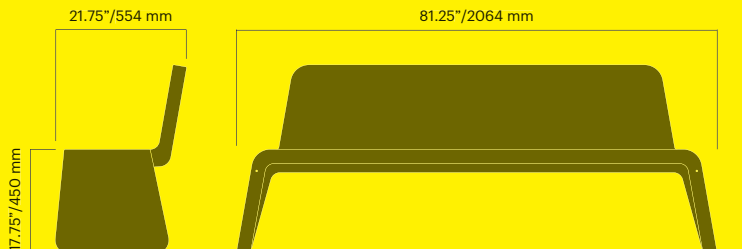

Kyoto table

		kg CO ₂ e	MJ	lbs
Art. 2236-004	3 570 USD	105	3 773	981

Bolting to the ground recommended

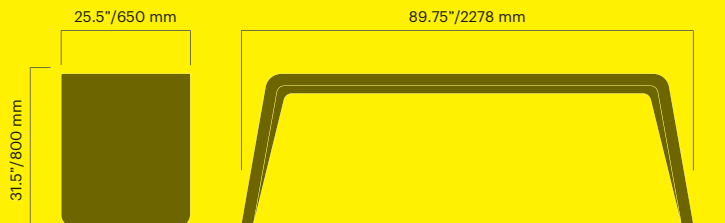



Move backless bench

		kg CO ₂ e	MJ	lbs
Art. 3106-900	2 310 USD	215	3 375	192
Art. 3106-901	2 120 USD	215	3 375	192

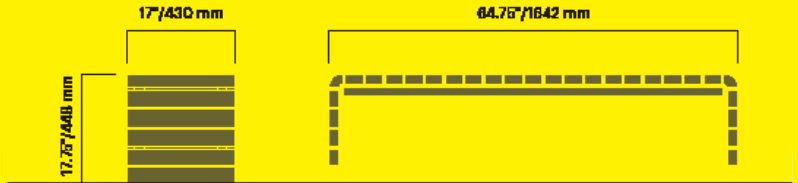

Munch



Munch stackable cafe chair

		kg CO ₂ e	MJ	lbs
Art. 5113-900	450 USD	36	497	24
Art. 5113-901	370 USD	36	497	24

Outdoor cushions available on request

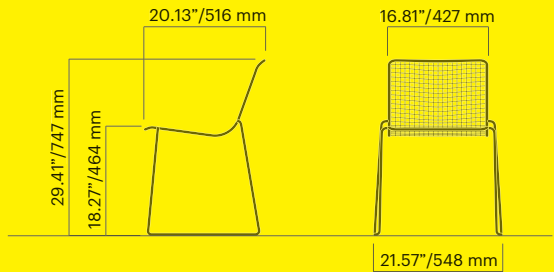

Munch lounge chair

		kg CO ₂ e	MJ	lbs
Art. 5166-900	1 150 USD	73	1 015	51
Art. 5166-901	1 000 USD	73	1 015	51

Outdoor cushions available on request

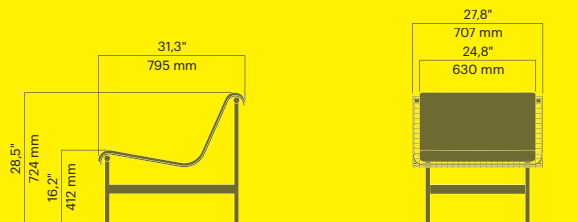

Munch lounge chair

With armrests

		kg CO ₂ e	MJ	lbs
Art. 5167-900	1 500 USD	86	1 205	71
Art. 5167-901	1 230 USD	86	1 205	71

Outdoor cushions available on request

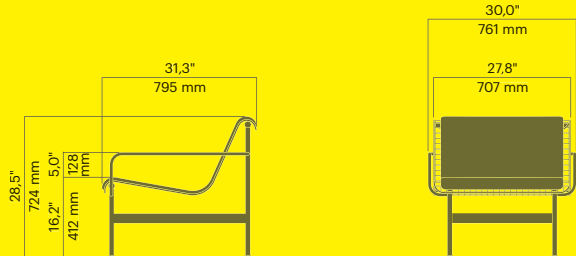
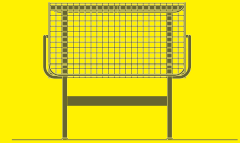

Munch backless bench

3-seater

		kg CO ₂ e	MJ	lbs
Art. 5106-900	1 260 USD	110	1 539	77
Art. 5106-901	1 080 USD	110	1 539	77

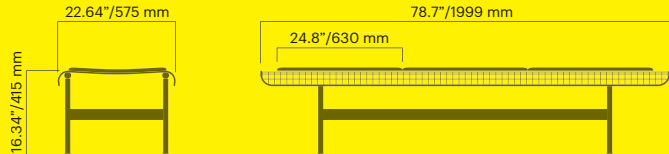

Munch backed bench

3-seater

		kg CO ₂ e	MJ	lbs
Art. 5116-901	1 460 USD	142	1 976	99
Art. 5116-900	1 590 USD	142	1 976	99

Outdoor cushions available on request

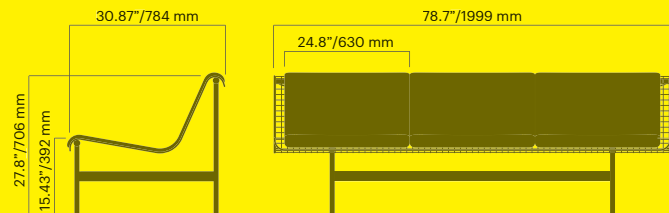
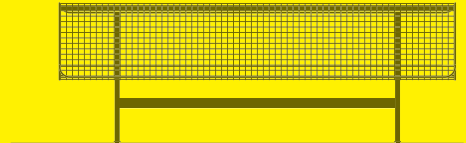

Munch backed bench

3-seater

		kg CO ₂ e	MJ	lbs
Art. 5117-900	1 940 USD	153	2 136	108
Art. 5117-901	1 660 USD	153	2 136	108

Outdoor cushions available on request

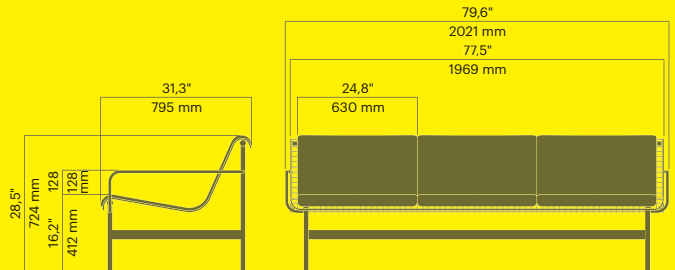
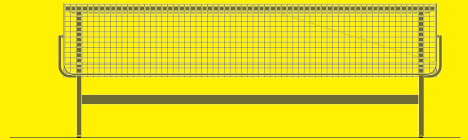

Munch steel table

Round

		kg CO ₂ e	MJ	lbs
Art. 5132-900	610 USD	113	1 577	68
Art. 5132-901	520 USD	113	1 577	68

Square

Art. 5134-900	640 USD	113	1 577	82
Art. 5134-901	560 USD	113	1 577	82

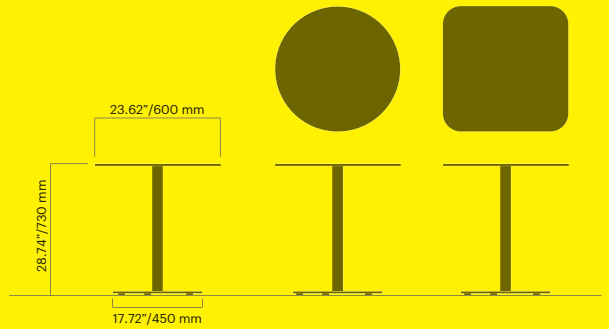

Munch steel table

Round, tall

		kg CO ₂ e	MJ	lbs
Art. 5137-900	630 USD	100	1 394	71
Art. 5137-901	550 USD	100	1 394	71

Square, tall

Art. 5138-900	680 USD	115	1 595	84
Art. 5138-901	600 USD	115	1 595	84

Round, low

Art. 5130-900	590 USD	96	1 340	68
Art. 5130-901	510 USD	96	1 340	68

Square, low

Art. 5131-900	620 USD	112	1 556	80
Art. 5131-901	540 USD	112	1 556	80

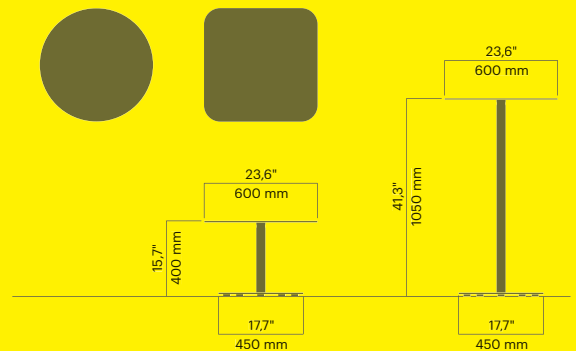



Parc chair

		kg CO ₂ e	MJ	lbs
Art. 2318-900	1 280 USD	48	936	43
Art. 2318-901	1 110 USD	48	936	43

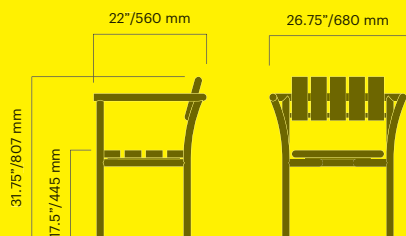

Parc backed bench

		kg CO ₂ e	MJ	lbs
Art. 2317-900	1 840 USD	77	1 594	108
Art. 2317-901	1 680 USD	77	1 594	108

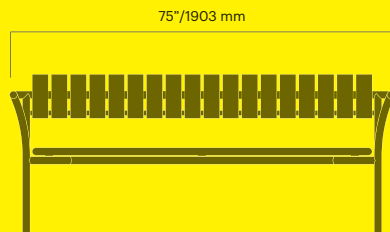

Parc table

		kg CO ₂ e	MJ	lbs
Art. 2336-900	1 460 USD	42	817	78
Art. 2336-901	1 380 USD	42	817	78

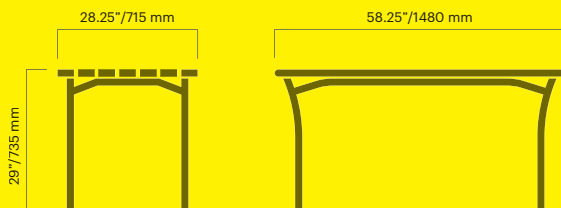

Parklet 2.0



Parklet 2.0 Urban floor

Floor with adjustable feet, fence and transition plate to pavement. Easily placed and moved with forklift.

		kg CO ₂ e	MJ	lbs
Art. 4470-900	11 030 USD	1907	30 345	1733
Art. 4470-901	10 530 USD	1907	30 345	1733

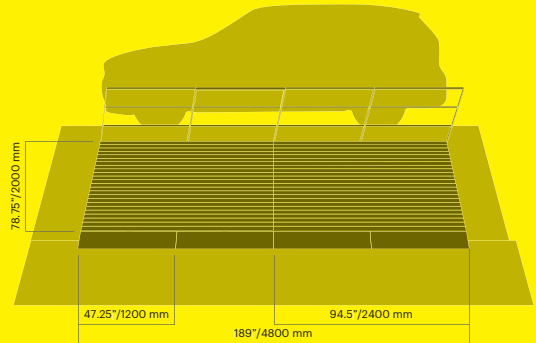

Parklet 2.0 Cozy

Complete with fence, transition plate to pavement, planter and sun benches. Easily placed and moved with forklift.

		kg CO ₂ e	MJ	lbs
Art. 4473-900	16 930 USD	2445	39 355	2338
Art. 4473-901	16 300 USD	2445	39 355	2291

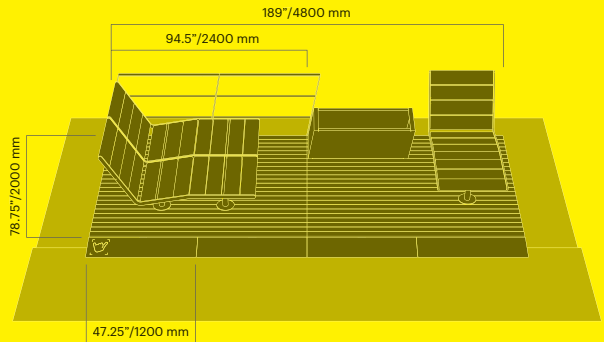

Parklet 2.0 Portal

Complete with transition plate to pavement, seats with armrest and planters. Easily placed and moved with forklift.

		kg CO ₂ e	MJ	lbs
Art. 4472-900	18 170 USD	3071	46 965	3000
Art. 4472-901	17 550 USD	3071	46 965	2606

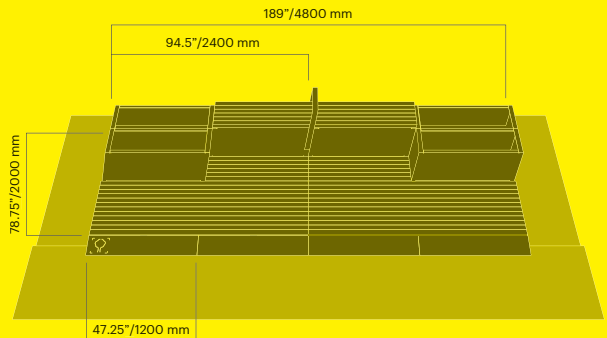

Parklet 2.0 Forest

Combination of small and large planters with integrated seat. Easily placed and moved with forklift.

		kg CO ₂ e	MJ	lbs
Art. 4474-900	18 800 USD	3907	55 326	2719
Art. 4474-901	17 550 USD	3907	55 326	2725

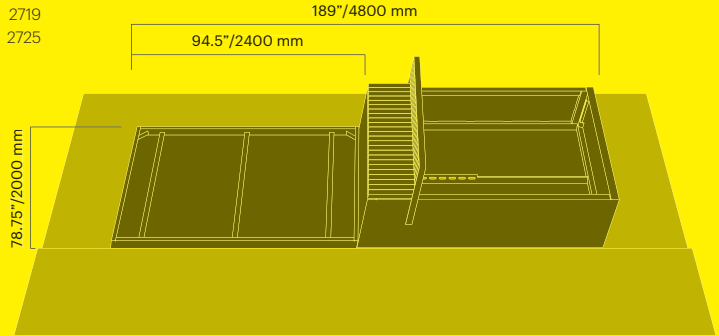

Parklet 2.0 Café

Complete with fence, transition plate to pavement, seats, bar table and planter.

		kg CO ₂ e	MJ	lbs
Art. 4471-900	23 810 USD	3566	52 678	3072
Art. 4471-901	21 380 USD	3566	52 678	3525

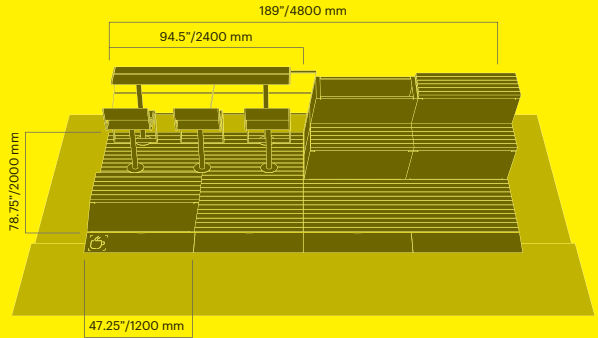

Parklet 2.0 floor and fence

Floor with adjustable feet		kg CO ₂ e	MJ	lbs
Art. 4401-901	3 690 USD	708	11 716	701

Fence length 47.25"		kg CO ₂ e	MJ	lbs
Art. 4454-900	550 USD	44	610	30
Art. 4454-901	430 USD	44	610	30

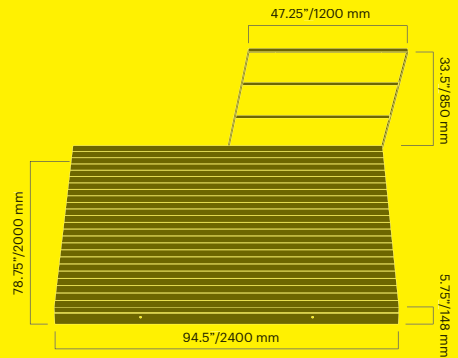

Parklet 2.0 transition plate

Transition plate without icon		kg CO ₂ e	MJ	lbs
Art. 4440-901	450 USD	72	994	52
Transition plate with icon				
Art. 4441-901	450 USD	67	918	48
Art. 4442-901	450 USD	67	923	48
Art. 4443-901	450 USD	67	918	48
Art. 4444-901	450 USD	67	923	48
Art. 4445-901	450 USD	67	923	49

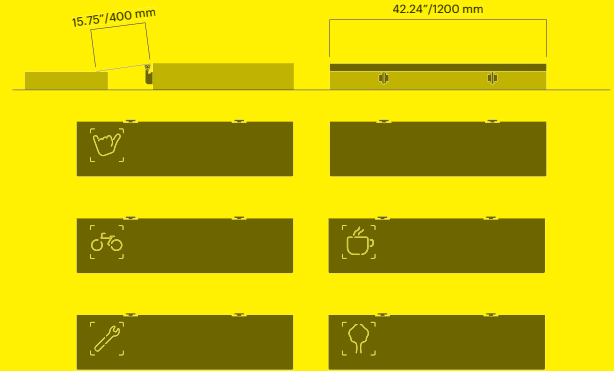

Parklet 2.0 Cycling

Cycle parking with adjustable feet and transition plate to pavement. Easily placed and moved with forklift.

6 bikes		kg CO ₂ e	MJ	lbs
Art. 4475-900	5 270 USD	1273	17 912	891
12 bikes				
Art. 4476-900	10 550 USD	3242	45 515	1782

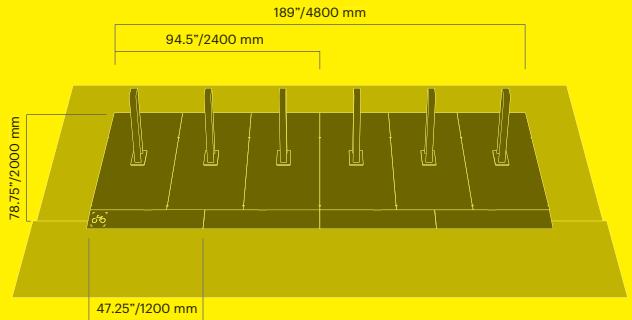

Parklet 2.0 Mech

Floor with adjustable feet, cycle repair stand, seat and transition plate to pavement. Easily placed and moved with forklift.

Art. 4477-900		kg CO ₂ e	MJ	lbs
10 790 USD	1273	17 912	1127	

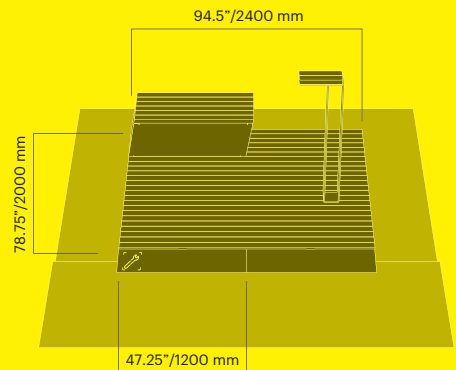

Parklet 2.0 seating module

		kg CO ₂ e	MJ	lbs
Art. 4406-900	1 690 USD	216	3 243	175
Art. 4406-901	1 490 USD	216	3 243	174

With armrest

Art. 4407-900	1 850 USD	229	3 422	254
Art. 4407-901	1 680 USD	229	3 422	254

Without wood

Art. 4403-900	1 120 USD	189	2 630	132
Art. 4403-901	970 USD	189	2 630	132

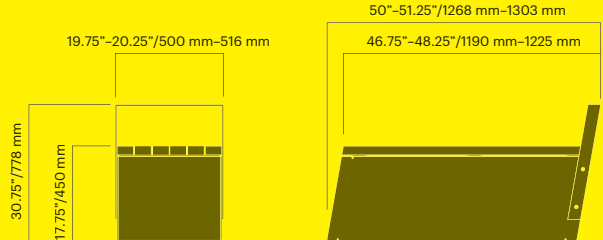

Parklet 2.0 small planter

Integrated water reservoir and drainage

		kg CO ₂ e	MJ	lbs
Art. 4488-900	1 350 USD	227	3 161	159
Art. 4488-901	1 230 USD	227	3 161	159

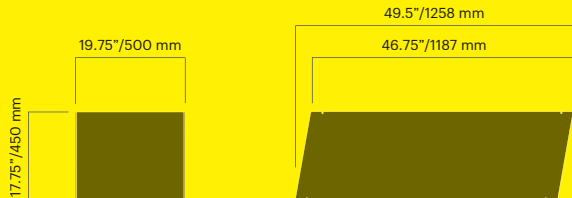

Parklet 2.0 large planter

Low		kg CO ₂ e	MJ	lbs
Art. 4486-901	5 150 USD	1210	16 876	844

High

Art. 4480-900	10 650 USD	2070	28 901	1618
Art. 4480-901	9 770 USD	2070	28 901	1618

Seating

Art. 4420-900MK	1 780 USD	176	2 848	165
Art. 4420-901MK	1 660 USD	176	2 848	168

Backrest

Art. 4421-900	1 350 USD	101	1 607	92
Art. 4421-901	1 220 USD	101	1 607	93

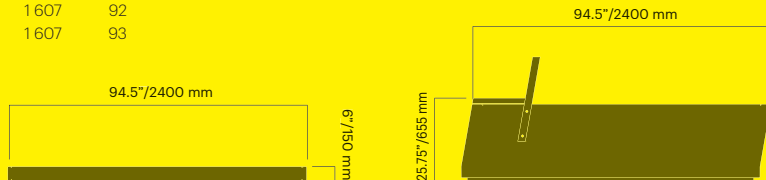



Plinth backless bench

H9.8" anchoring A and C

Art.	Price	kg CO ₂ e	MJ	lbs
Art. 5603-900A	930 USD	63	1 011	75
Art. 5603-901A	800 USD	63	1 011	75
Art. 5603-900c	940 USD	126	1 887	75
Art. 5603-901c	810 USD	126	1 887	75

H17.7" anchoring A and C

Art. 5604-900A	1 190 USD	112	1 690	108
Art. 5604-901A	1 030 USD	112	1 690	108
Art. 5604-900C	1 190 USD	167	2 459	108
Art. 5604-901C	1 030 USD	167	2 459	108

H29.1" anchoring A and C

Art. 5605-900A	1 490 USD	162	2 393	128
Art. 5605-901A	1 290 USD	162	2 393	128
Art. 5605-900C	1 490 USD	227	3 294	128
Art. 5605-901C	1 290 USD	227	3 294	128

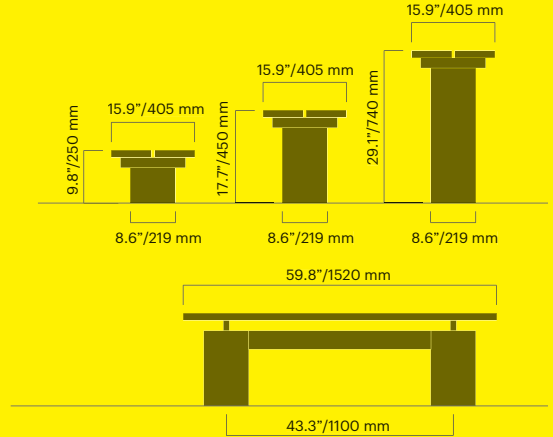

Plinth long backless bench

H9.8" anchoring A and C

Art.	Price	kg CO ₂ e	MJ	lbs
Art. 5606-900A	1 490 USD	91	1 504	110
Art. 5606-901A	1 330 USD	91	1 504	110
Art. 5606-900C	1 490 USD	188	2 860	110
Art. 5606-901C	1 330 USD	188	2 860	110

H17.7" anchoring A and C

Art. 5607-900A	1 740 USD	153	2 367	157
Art. 5607-901A	1 490 USD	153	2 367	157
Art. 5607-900C	1 740 USD	250	3 724	157
Art. 5607-901C	1 490 USD	250	3 724	157

H29.1" anchoring A and C

Art. 5608-900A	1 970 USD	243	3 620	196
Art. 5608-901A	1 690 USD	243	3 620	196
Art. 5608-900C	1 970 USD	340	4 975	196
Art. 5608-901C	1 690 USD	340	4 975	196

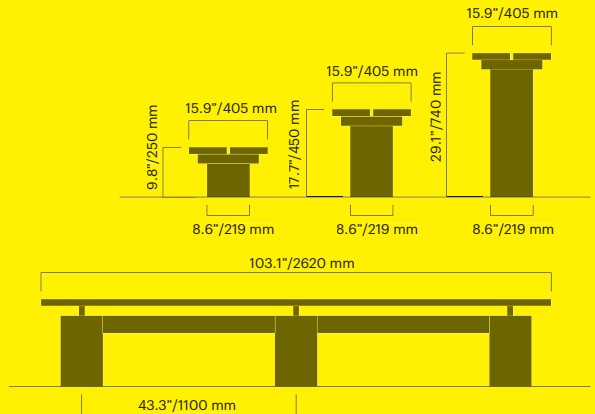

Plinth backed bench

Anchoring A and C

		kg CO ₂ e	MJ	lbs
Art. 5613-900A	1 490 USD	145	2 149	141
Art. 5613-901A	1 240 USD	145	2 149	141
Art. 5613-900C	1 490 USD	214	3 111	165
Art. 5613-901C	1 240 USD	214	3 111	165

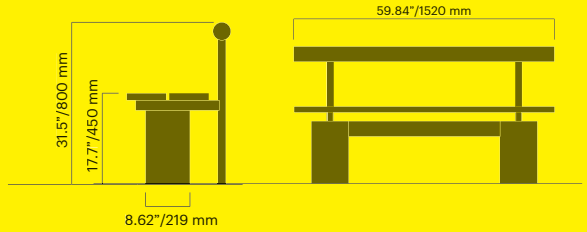

Plinth long backed bench

Anchoring A and C

		kg CO ₂ e	MJ	lbs
Art. 5614-900A	2 480 USD	224	3 353	183
Art. 5614-901A	2 120 USD	224	3 353	183
Art. 5614-900C	2 480 USD	327	4 794	256
Art. 5614-901C	2 120 USD	327	4 794	256

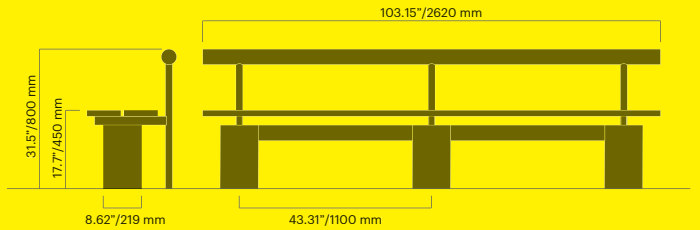

Plinth table

H9.8\" anchoring A and C

		kg CO ₂ e	MJ	lbs
Art. 5632-900A	1 030 USD	66	1 116	75
Art. 5632-901A	900 USD	66	1 116	75
Art. 5632-900C	1 030 USD	131	2 018	143
Art. 5632-901C	900 USD	131	2 018	143

H17.7\" anchoring A and C

Art. 5633-900A	1 270 USD	107	1 689	124
Art. 5633-901A	1 070 USD	107	1 689	123
Art. 5633-900C	1 270 USD	168	2 528	115
Art. 5633-901C	1 070 USD	168	2 528	115

H29.1\" anchoring A and C

Art. 5634-900A	1 490 USD	168	2 528	176
Art. 5634-901A	1 270 USD	168	2 528	176
Art. 5634-900C	1 490 USD	208	3 096	218
Art. 5634-901C	1 270 USD	208	3 096	218

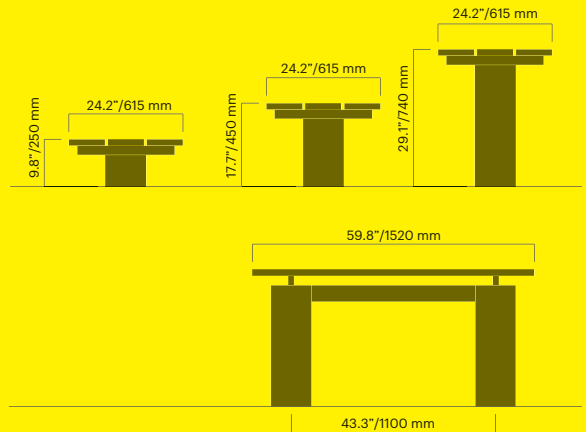

Plinth long table

H9.8" anchoring A and C

		kg CO ₂ e	MJ	lbs
Art. 5635-900A	1 680 USD	100	1 729	130
Art. 5635-901A	1 490 USD	100	1 729	130
Art. 5635-900C	1 670 USD	197	3 085	205
Art. 5635-901C	1 490 USD	197	3 085	205

H17.7" anchoring A and C

Art. 5636-900A	1 900 USD	162	2 592	174
Art. 5636-901A	1 700 USD	162	2 592	174
Art. 5636-900C	1 900 USD	259	3 949	252
Art. 5636-901C	1 700 USD	259	3 949	251

H29.1" anchoring A and C

Art. 5637-900A	2 150 USD	252	3 850	245
Art. 5637-901A	1 850 USD	252	3 850	245
Art. 5637-900C	2 150 USD	349	5 200	282
Art. 5637-901C	1 850 USD	349	5 200	282

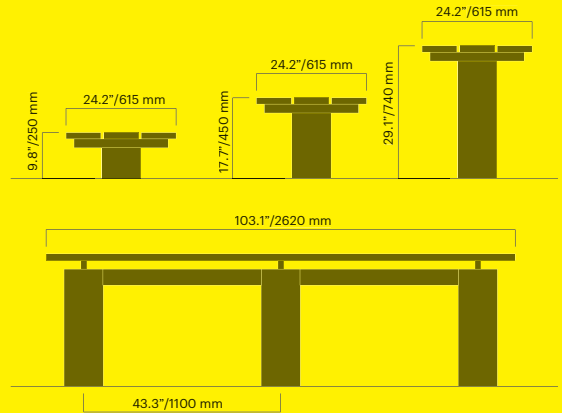

Plinth bike rack

Anchoring A and C

		kg CO ₂ e	MJ	lbs
Art. 5686-900A	480 USD	43	600	32
Art. 5686-901A	320 USD	43	600	33
Art. 5686-900C	480 USD	41	573	32
Art. 5686-901C	410 USD	41	573	29

bike rack long

Art. 5687-900A	540 USD	77	1 079	60
Art. 5687-901A	580 USD	77	1 079	59
Art. 5687-900C	590 USD	69	957	58
Art. 5687-901C	460 USD	69	957	58

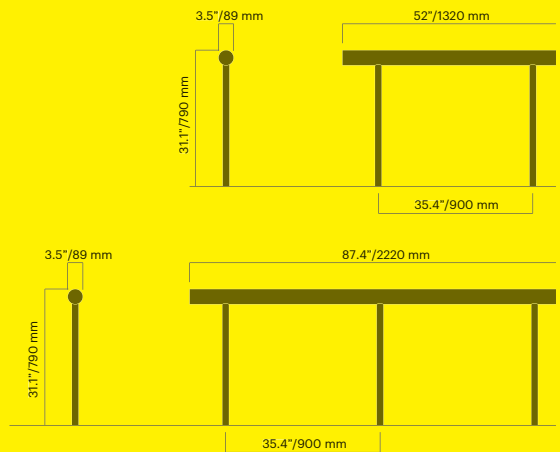

Pop



Pop backless bench

		kg CO ₂ e	MJ	lbs
Art. 3806-900	990 USD	63	910	53
Art. 3806-901	730 USD	63	910	53

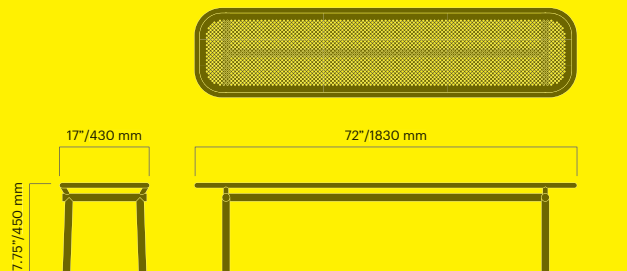

Pop backed bench

		kg CO ₂ e	MJ	lbs
Art. 3816-900	1 550 USD	101	1 462	81
Art. 3816-901	1 190 USD	101	1 462	82

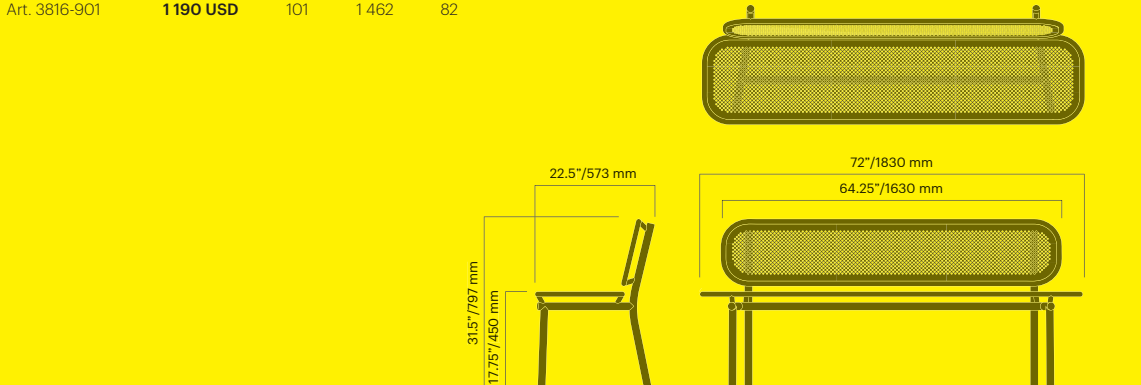

Pop backed bench with armrests

		kg CO ₂ e	MJ	lbs
Art. 3817-900	1 750 USD	108	1 565	81
Art. 3817-901	1 400 USD	108	1 565	81

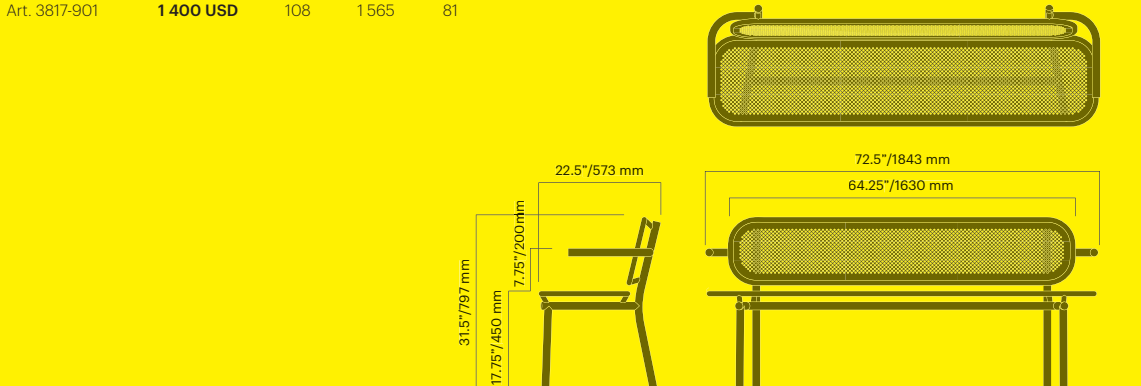

Pop table

		kg CO ₂ e	MJ	lbs
Art. 3836-900	1 090 USD	88	1 286	93
Art. 3836-901	920 USD	88	1 286	93

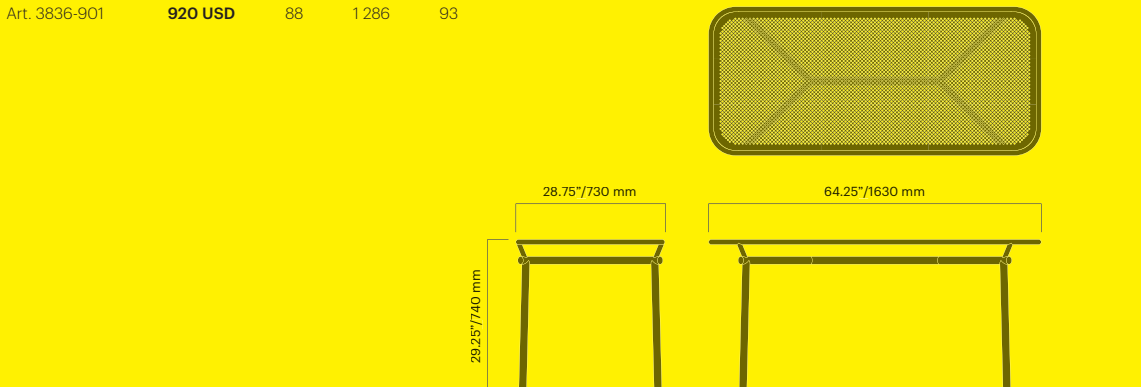

Pop planter

27 gallons

		kg CO ₂ e	MJ	lbs
Low				
Art. 3880-900	1 360 USD	277	3 857	189
Art. 3880-901	1 140 USD	277	3 857	189
High				
Art. 3882-900	1 930 USD	457	6 357	282
Art. 3882-901	1 700 USD	457	6 357	282

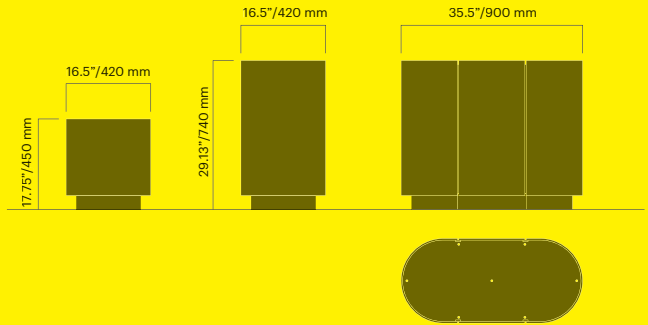

Pop planter

63 gallons

		kg CO ₂ e	MJ	lbs
Low				
Art. 3884-900	2 450 USD	567	7 892	326
Art. 3884-901	2 320 USD	567	7 892	326
High				
Art. 3886-900	3 140 USD	819	11 401	542
Art. 3886-901	2 770 USD	819	11 401	542

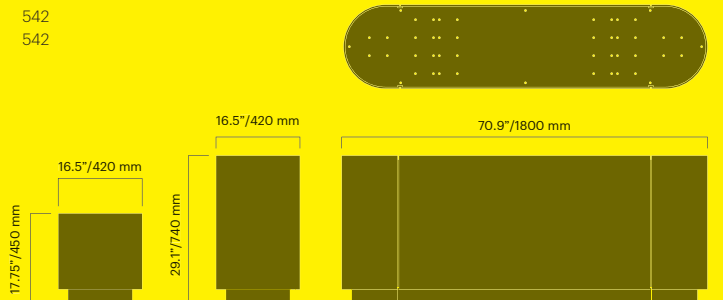

Pop urban screen #1

		kg CO ₂ e	MJ	lbs
Art. 3870-900A	1 530 USD	114	1 681	77
Art. 3870-901A	1 300 USD	114	1 681	77

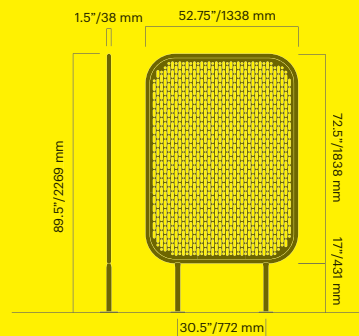

Pop urban screen #2

		kg CO ₂ e	MJ	lbs
Art. 3872-900A	1 740 USD	128	1 899	101
Art. 3872-901A	1 480 USD	128	1 899	101

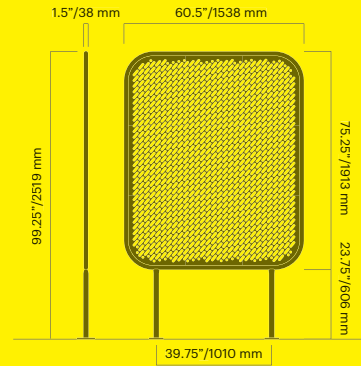

Pop urban screen #3

		kg CO ₂ e	MJ	lbs
Art. 3874-900A	1 640 USD	128	1 881	97
Art. 3874-901A	1 390 USD	128	1 881	97

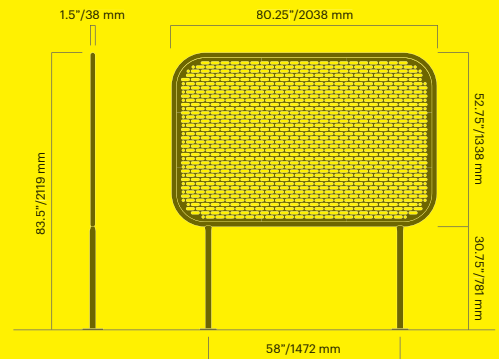

Porto



Porto backless bench A

Free-standing		kg CO ₂ e	MJ	lbs
Art. 401-900	2 880 USD	135	2 931	201
Art. 401-901	2 700 USD	135	2 931	201

For wall top		kg CO ₂ e	MJ	lbs
Art. 401-901MK	2 310 USD	78	2 122	162

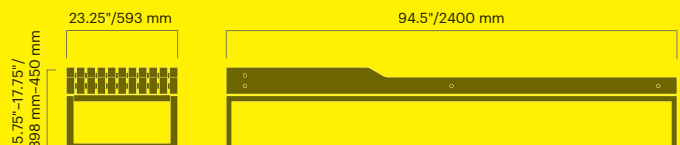

Porto backless bench B

Free-standing		kg CO ₂ e	MJ	lbs
Art. 402-900	2 880 USD	149	3 428	238
Art. 402-901	2 700 USD	149	3 428	238
For wall top				
Art. 402-901MK	2 310 USD	90	2 604	198

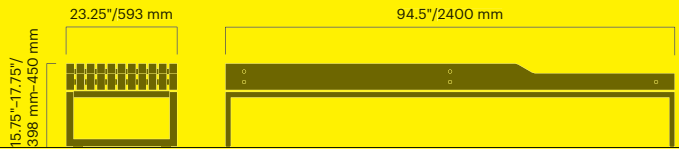

Porto backless bench C

Free-standing		kg CO ₂ e	MJ	lbs
Art. 403-900	2 880 USD	149	3 429	235
Art. 403-901	2 700 USD	149	3 429	235
For wall top				
Art. 403-901MK	2 310 USD	91	2 590	190

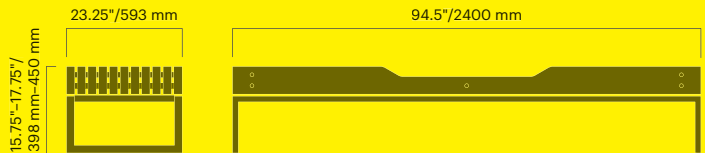

Porto backless bench D

Free-standing		kg CO ₂ e	MJ	lbs
Art. 404-900	2 880 USD	137	2 981	202
Art. 404-901	2 700 USD	137	2 981	202
For wall top				
Art. 404-901MK	2 310 USD	79	2 173	198

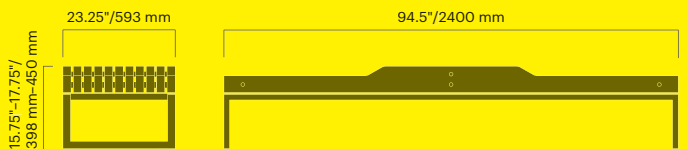

Porto backless bench E

Free-standing		kg CO ₂ e	MJ	lbs
Art. 405-900	2 090 USD	126	2 636	176
Art. 405-901	1 860 USD	126	2 636	176
For wall top				
Art. 405-901MK	1 380 USD	69	1 827	137

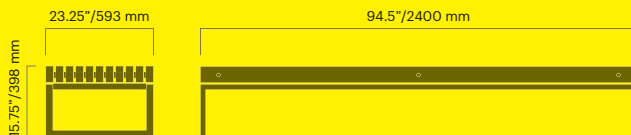

Porto backless bench F

Free-standing		kg CO ₂ e	MJ	lbs
Art. 406-900	2 740 USD	156	3 595	252
Art. 406-901	2 580 USD	156	3 595	248
For wall top				
Art. 406-901MK	2 110 USD	98	2 787	209

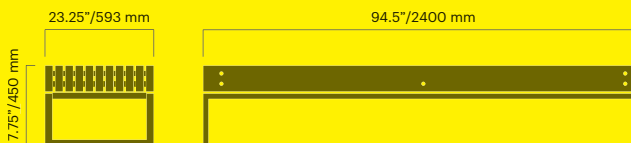

Porto backless bench K

Free-standing		kg CO ₂ e	MJ	lbs
Art. 407-900	4 270 USD	151	3 505	246
Art. 407-901	4 190 USD	151	3 505	246
For wall top				
Art. 407-901MK	3 860 USD	95	2 718	211

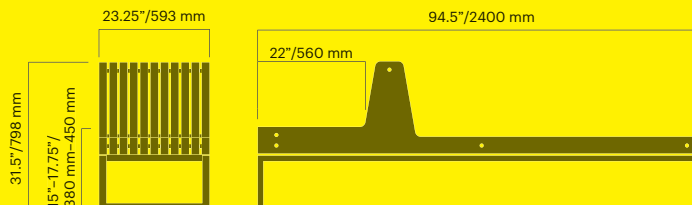

Porto backless bench

For wall top

H: 5.25"		kg CO ₂ e	MJ	lbs
Art. 420-900MK	990 USD	39	1 020	73
Art. 420-901MK	970 USD	39	1 020	73
H: 7.25"				
Art. 421-900MK	1 150 USD	54	1 523	117
Art. 421-901MK	1 160 USD	54	1 523	113

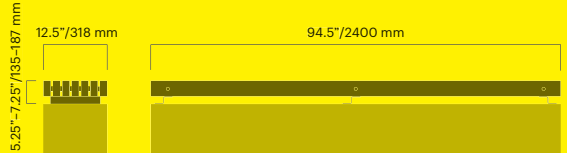

Porto back and armrests

Armrest		kg CO ₂ e	MJ	lbs
Art. 425-900E	260 USD	8	116	6
Art. 425-901E	240 USD	8	116	6
Back				
Art. 423-900E	950 USD	33	748	51
Art. 423-901E	860 USD	33	748	51
Back and armrest complete				
Art. 427-900	600 USD	27	410	22
Art. 427-901	550 USD	27	410	22
Art. 428-900	600 USD	27	410	22
Art. 428-901	550 USD	27	410	22

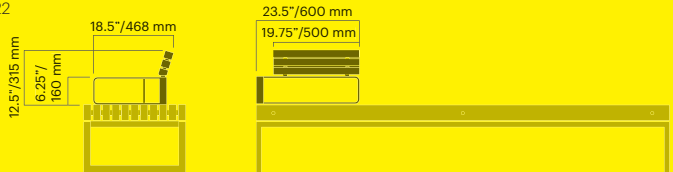

Reale



Reale planter

34 gallons		kg CO ₂ e	MJ	lbs
Art. rea 065-057	1 100 USD	-	-	77



Reale planter

90 gallons

Art. rea 090-090

1 610 USD

kg CO₂e

-

MJ

-

lbs

165

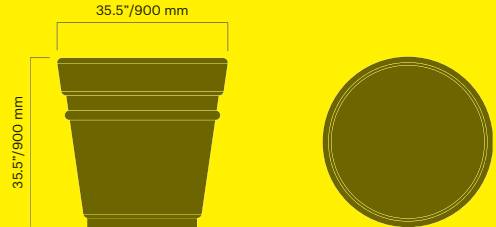

Reale planter

158 gallons

Art. rea 120-070

1 780 USD

kg CO₂e

-

MJ

-

lbs

176

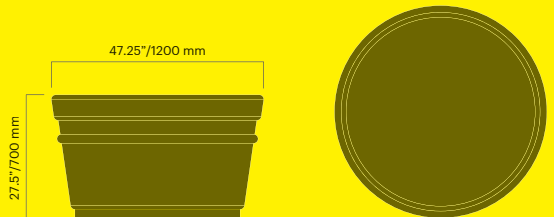

Reale planter

291 gallons

Art. rea 130-130

3 450 USD

kg CO₂e

-

MJ

-

lbs

309

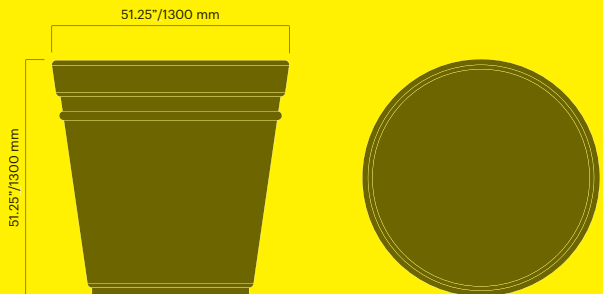



Sinus bike rack

For 5 bikes

Anchoring A or C		kg CO ₂ e	MJ	lbs
Art. 381-900A	570 USD	64	866	40
Art. 381-901A	480 USD	64	866	40
Art. 381-900C	480 USD	65	889	40
Art. 381-901C	430 USD	65	889	40

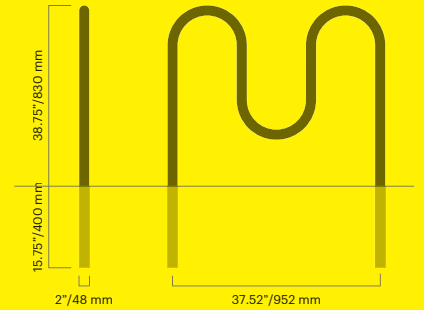

Sinus bike rack

For 7 bikes

Anchoring A or C		kg CO ₂ e	MJ	lbs
Art. 383-900A	660 USD	88	1195	53
Art. 383-901A	590 USD	88	1195	53
Art. 383-900C	590 USD	90	1219	43
Art. 383-901C	480 USD	90	1219	43

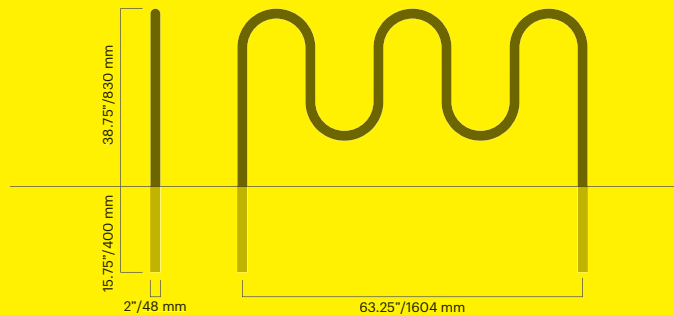

Sinus bike rack

For 9 bikes

Anchoring A or C		kg CO ₂ e	MJ	lbs
Art. 385-900A	800 USD	114	1553	68
Art. 385-901A	650 USD	114	1553	68
Art. 385-900C	720 USD	116	1572	55
Art. 385-901C	570 USD	116	1572	55

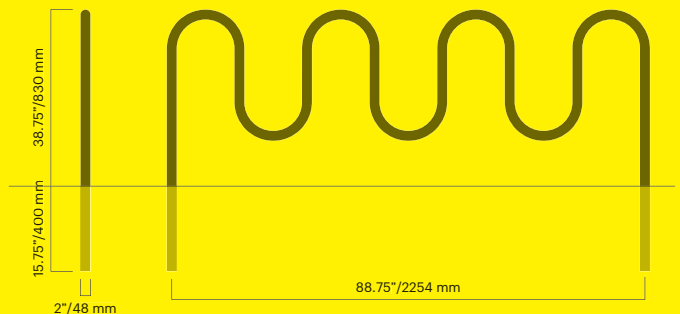



Stones module #1

Backless bench H17.7"

		kg CO ₂ e	MJ	lbs
Art. 5202-900	4 270 USD	315	4 971	247
Art. 5202-901	3 500 USD	315	4 971	247

Backless bench H23.6"

Art. 5204-900	4 540 USD	347	5 164	276
Art. 5204-901	3 690 USD	347	5 164	276

Planter H15.7", 85 gallons

Art. 5280-900	3 350 USD	373	5 197	269
Art. 5280-901	2 490 USD	373	5 197	269

Planter H21.6", 132 gallons

Art. 5282-900	3 500 USD	373	5 197	300
Art. 5282-901	2 710 USD	373	5 197	300

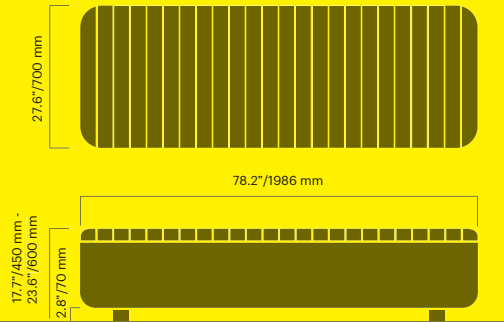

Stones module #2

Backless bench H17.7"

		kg CO ₂ e	MJ	lbs
Art. 5206-900	3 840 USD	261	3 951	216
Art. 5206-901	3 080 USD	261	3 951	216

Backless bench H23.6"

Art. 5208-900	4 120 USD	314	4 685	254
Art. 5208-901	3 200 USD	314	4 685	254

Planter H15.7", 85 gallons

Art. 5284-900	3 100 USD	326	4 545	240
Art. 5284-901	2 350 USD	326	4 545	240

Planter H21.6", 132 gallons

Art. 5286-900	3 460 USD	375	5 220	278
Art. 5286-901	2 580 USD	375	5 220	278

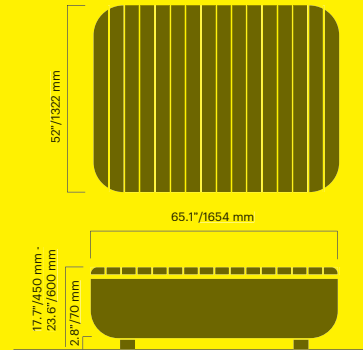

Stones module #3

Backless bench H17.7"

		kg CO ₂ e	MJ	lbs
Art. 5210-900	4 620 USD	348	5 352	298
Art. 5210-901	3 760 USD	348	5 352	298

Backless bench H23.6"

Art. 5212-900	4 830 USD	415	6 290	346
Art. 5212-901	4 050 USD	415	6 290	346

Planter H15.7", 85 gallons

Art. 5288-900	3 620 USD	460	6 412	344
Art. 5288-901	2 870 USD	460	6 412	344

Planter H21.6", 132 gallons

Art. 5290-900	3 860 USD	524	7 294	390
Art. 5290-901	3 080 USD	524	7 294	390

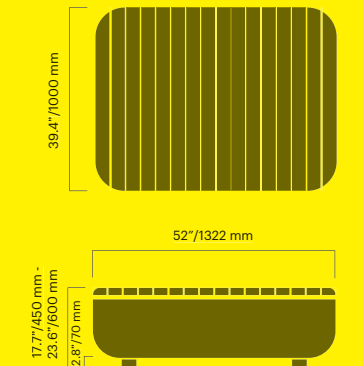

Stoop



Stoop mini

		kg CO ₂ e	MJ	lbs
Art. 2413-900	3 750 USD	507	7 275	311
Art. 2413-901	3 130 USD	507	7 275	311

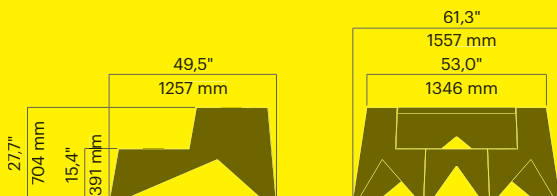

Stoop backed bench

		kg CO ₂ e	MJ	lbs
Art. 2417-900	5 270 USD	615	9 168	497
Art. 2417-901	4 250 USD	615	9 168	497

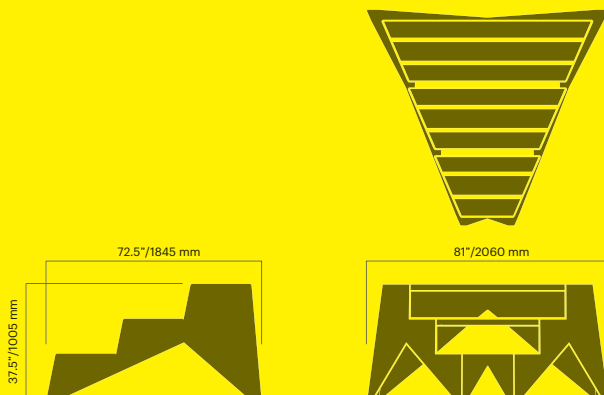

Stoop picnic table

		kg CO ₂ e	MJ	lbs
Art. 2422-900	4 060 USD	442	6 898	456
Art. 2422-901	3 690 USD	442	6 898	456

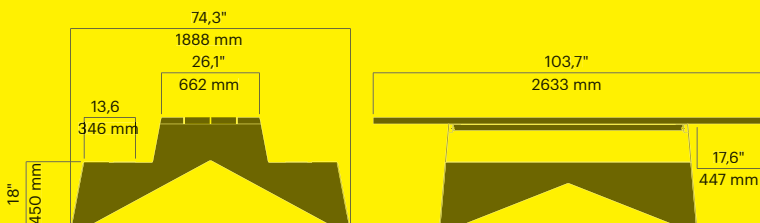



Stripes backless bench rectangular

		kg CO ₂ e	MJ	lbs
Art. 3606-900	2 690 USD	151	2 713	176
Art. 3606-901	2 480 USD	151	2 713	175

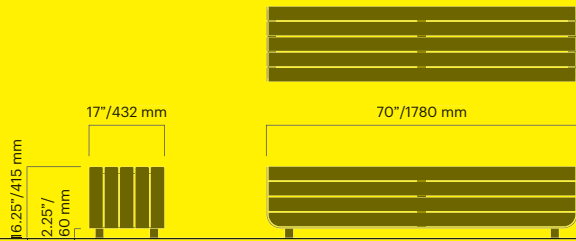

Stripes backless bench start and end module

Start and end		kg CO ₂ e	MJ	lbs
Art. 3607-900	2 280 USD	142	2 413	149
Art. 3607-901	2 030 USD	142	2 413	149

Add-on module

Art. 3608-900	1 830 USD	136	2 165	123
Art. 3608-901	1 560 USD	136	2 165	123

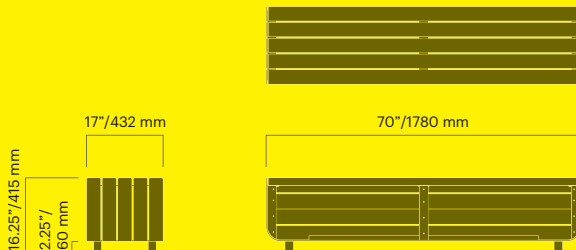

Stripes backless bench start and end module with aperture

Start and end		kg CO ₂ e	MJ	lbs
Art. 3607-900V	2 960 USD	180	2 932	164
Art. 3607-901V	2 730 USD	180	2 932	165
Art. 3607-900M	2 960 USD	177	2 885	160
Art. 3607-901M	2 730 USD	177	2 885	169
Art. 3607-900H	2 960 USD	180	2 932	164
Art. 3607-901H	2 730 USD	180	2 932	164

Add-on module

Art. 3608-900V	2 640 USD	172	2 612	138
Art. 3608-901V	2 400 USD	172	2 612	139
Art. 3608-900M	2 640 USD	166	2 528	134
Art. 3608-901M	2 400 USD	166	2 528	132
Art. 3608-900H	2 640 USD	172	2 612	138
Art. 3608-901H	2 400 USD	172	2 612	138

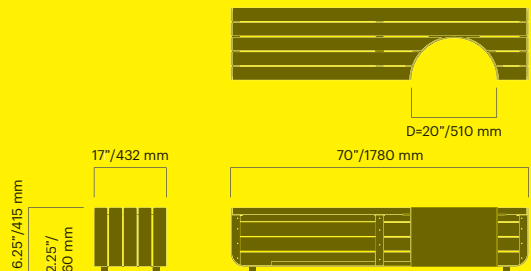

Stripes circle backless bench small

		kg CO ₂ e	MJ	lbs
Art. 3612-900	4 250 USD	324	4 761	238
Art. 3612-901	3 750 USD	324	4 761	238

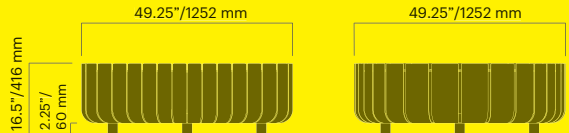
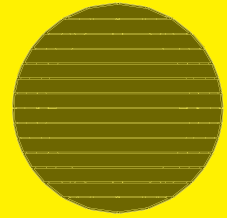

Stripes circle backless bench large

		kg CO ₂ e	MJ	lbs
Art. 3610-900	4 990 USD	459	7 193	406
Art. 3610-901	4 270 USD	459	7 193	407

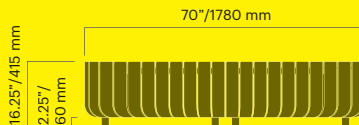
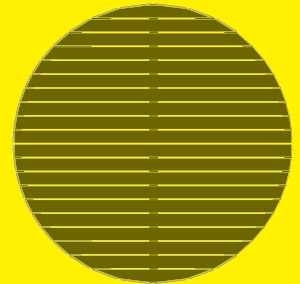

Stripes circle backless bench with plant aperture

		kg CO ₂ e	MJ	lbs
Art. 3611-900HV	7 080 USD	537	8 284	442
Art. 3611-901HV	6 240 USD	537	8 284	467
Art. 3611-900M	7 080 USD	518	8 012	454
Art. 3611-901M	6 240 USD	518	8 012	459

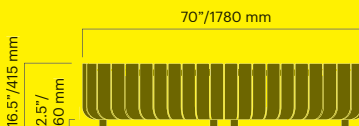
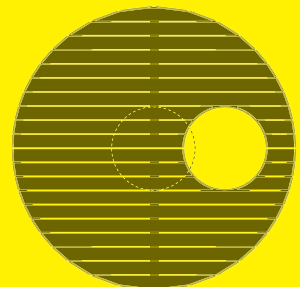

Stripes backless bench semicircle

Open module		kg CO ₂ e	MJ	lbs
Art. 3616-900	2 480 USD	228	3 581	203
Art. 3616-901	2 130 USD	228	3 581	203
Closed module				
Art. 3617-900	2 990 USD	236	3 858	230
Art. 3617-901	2 700 USD	236	3 858	230

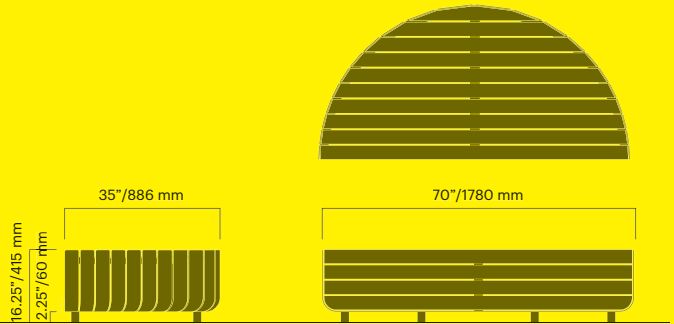

Stripes backed bench open semicircle with plant aperture

		kg CO ₂ e	MJ	lbs
Art. 3616-900V	3 540 USD	269	4 142	208
Art. 3616-901V	3 120 USD	269	4 142	208
Art. 3616-900M	3 540 USD	261	4 058	208
Art. 3616-901M	3 120 USD	261	4 058	209
Art. 3616-900H	3 540 USD	269	4 142	208
Art. 3616-901H	3 120 USD	269	4 142	208

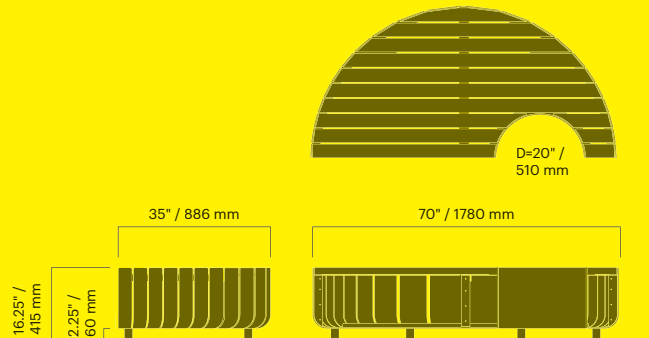

Stripes planter small

Low		kg CO ₂ e	MJ	lbs
Art. 3678-900	3 750 USD	478	6 665	333
Art. 3678-901	3 100 USD	478	6 665	333
High				
Art. 3674-900	4 990 USD	734	10 230	514
Art. 3674-901	4 270 USD	734	0	511

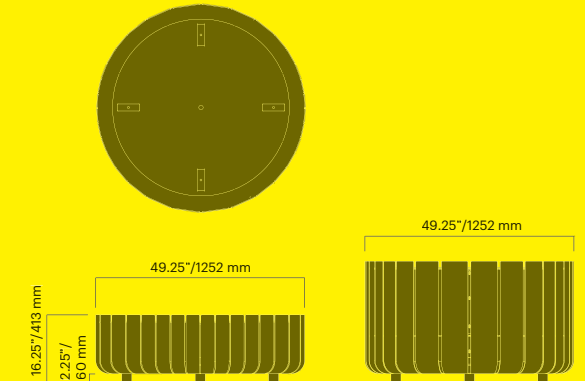

Stripes planter large

119 gallons

		kg CO ₂ e	MJ	lbs
Art. 3684-900	5 960 USD	894	12 457	620
Art. 3684-901	5 330 USD	894	12 457	619

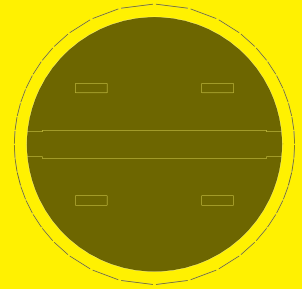

Stripes semicircle planter

Closed module		kg CO ₂ e	MJ	lbs
Art. 3683-900	3 750 USD	515	6 665	352
Art. 3683-901	3 100 USD	515	0	353
Open module for connection				
Art. 3682-900	2 990 USD	454	6 324	315
Art. 3682-901	2 650 USD	454	0	315

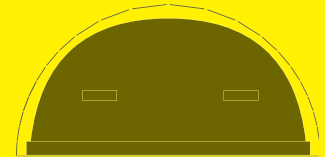

Tour

Tour bike rack

For 2 bikes

Anchoring A or C		kg CO ₂ e	MJ	lbs
Art. 2886-900A	490 USD	75	1 046	53
Anchoring A or C				
Art. 2886-901A	410 USD	75	1 046	53
Art. 2886-900C	470 USD	92	1 276	64
Art. 2886-901C	390 USD	92	1 276	64

Other patterns on request

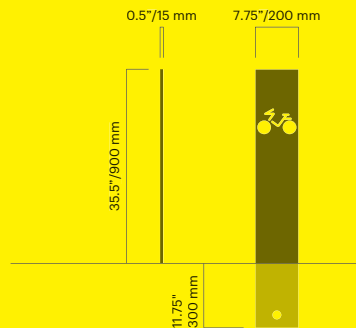



Urban backless bench

Narrow bench, anchoring A or C		kg CO ₂ e	MJ	lbs
Art. 503-900A	1 000 USD	69	1 192	77
Art. 503-901A	880 USD	69	1 192	77
Art. 503-900C	1 000 USD	76	1 286	77
Art. 503-901C	880 USD	76	1 286	77
Wide bench, anchoring A or C		kg CO ₂ e	MJ	lbs
Art. 504-900A	1 110 USD	73	1 306	88
Art. 504-901A	1 020 USD	73	1 306	88
Art. 504-900C	1 110 USD	81	1 409	88
Art. 504-901C	1 020 USD	81	1 409	88

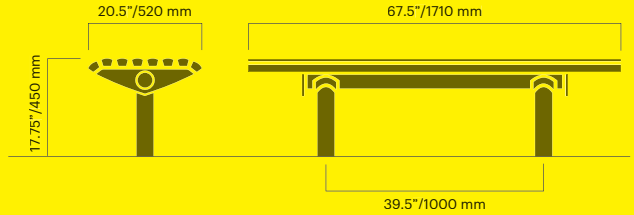

Urban backless bench

Narrow bench, free-standing		kg CO ₂ e	MJ	lbs
Art. 506-900	1 120 USD	80	1 347	79
Art. 506-901	950 USD	80	1 347	79
Wide bench, free-standing		kg CO ₂ e	MJ	lbs
Art. 507-900	1 240 USD	85	1 475	88
Art. 507-901	1 070 USD	85	1 475	88

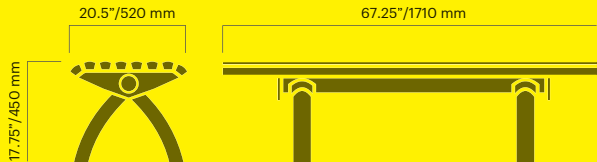

Urban backless bench

Narrow bench, with granite pedestals		kg CO ₂ e	MJ	lbs
Art. 508-900	1 860 USD	87	1 945	220
Art. 508-901	1 690 USD	87	1 945	220
Wide bench, with granite pedestals		kg CO ₂ e	MJ	lbs
Art. 509-900	2 050 USD	92	2 074	229
Art. 509-901	1 820 USD	92	2 074	229

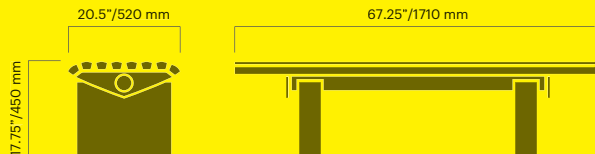

Urban armrests for backless bench

Armrest pair		kg CO ₂ e	MJ	lbs
Art. 526-900	320 USD	17	236	9
Art. 526-901	250 USD	17	236	9

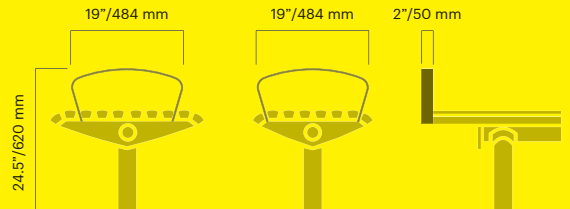

Urban backed bench

Anchoring A,B or C		kg CO ₂ e	MJ	lbs
Art. 513-900A	1260 USD	82	1508	98
Art. 513-901A	1100 USD	82	1508	98
Art. 513-900B	1260 USD	82	1508	98
Art. 513-901B	1100 USD	82	1508	98
Art. 513-900C	1260 USD	87	1424	103
Art. 513-901C	1100 USD	87	1424	102

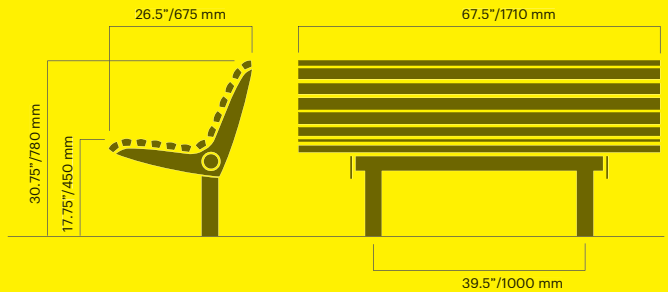

Urban backed bench

Free-standing		kg CO ₂ e	MJ	lbs
Art. 516-900	1620 USD	90	1625	104
Art. 516-901	1470 USD	90	1625	104

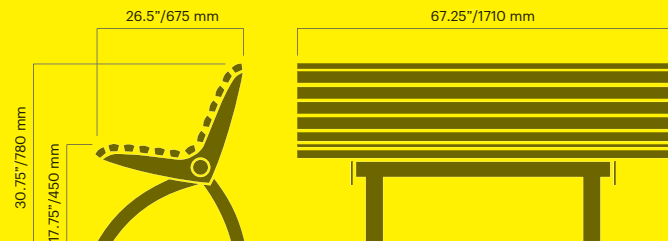

Urban backed bench

With granite pedestals

		kg CO ₂ e	MJ	lbs
Art. 518-900	2 310 USD	84	1 601	222
Art. 518-901	2 190 USD	84	1 601	222

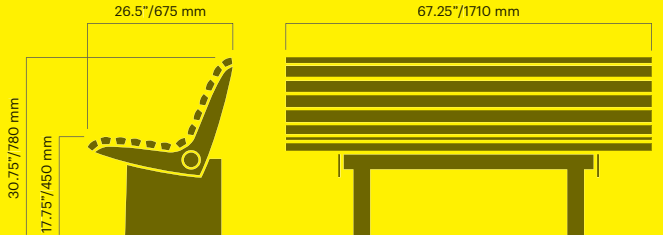

Urban armrests for backed benches

Armrest pair

		kg CO ₂ e	MJ	lbs
Art. 525-900	330 USD	19	259	13
Art. 525-901	280 USD	19	259	13

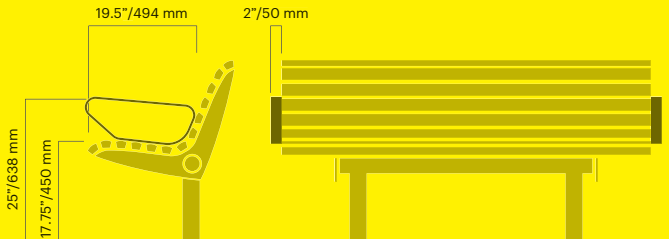

Urban sun bench

Free-standing / for bolting

		kg CO ₂ e	MJ	lbs
Art. 566-900	2 320 USD	167	2 658	192
Art. 566-901	1 990 USD	167	2 658	174

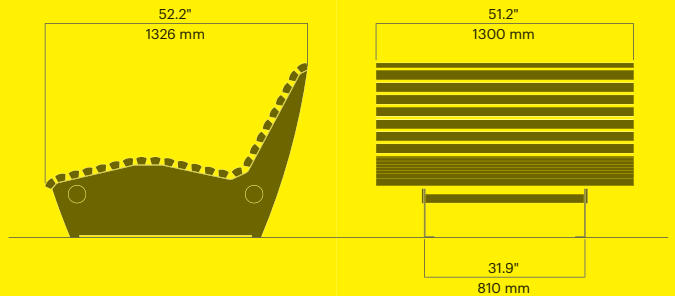

Urban table

Anchoring A or C

		kg CO ₂ e	MJ	lbs
Art. 533-900A	1140 USD	97	1 656	106
Art. 533-901A	990 USD	97	1 656	106
Art. 533-900C	1140 USD	96	1 627	98
Art. 533-901C	990 USD	96	1 627	98

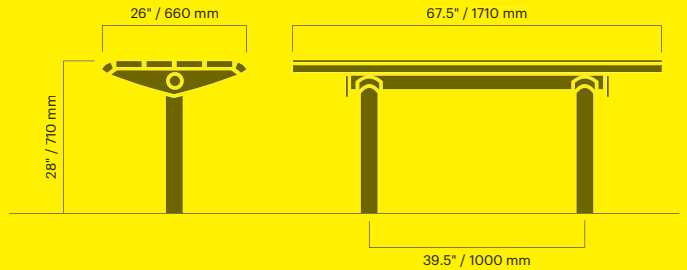

Urban table

Free-standing

		kg CO ₂ e	MJ	lbs
Art. 536-900	1370 USD	86	1 498	106
Art. 536-901	1240 USD	86	1 498	106

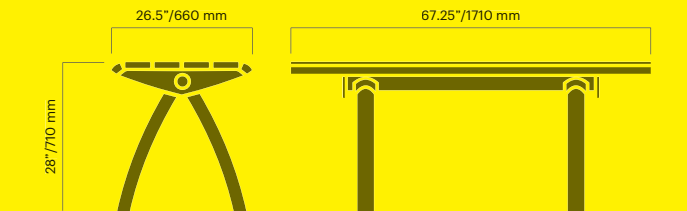

Urban table

Anchoring A or C

		kg CO ₂ e	MJ	lbs
Art. 539-900A	1340 USD	102	1 772	106
Art. 539-901A	1160 USD	102	1 772	108
Art. 539-900C	1340 USD	97	1 711	107
Art. 539-901C	1160 USD	97	1 711	107

Free-standing

		kg CO ₂ e	MJ	lbs
Art. 539-900	1520 USD	102	1 722	106
Art. 539-901	1370 USD	102	1 722	105

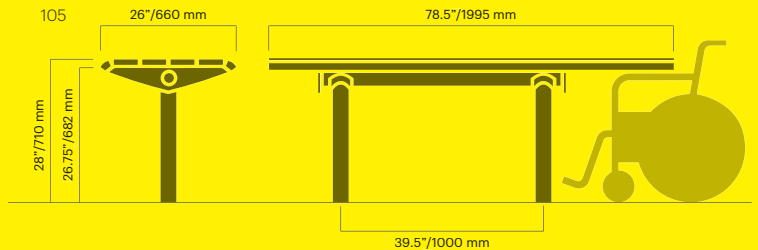

Urban litter receptacle

7 gallons

For wall or mounting pole		kg CO ₂ e	MJ	lbs
Art. 541-900	770 USD	38	535	26
For wall or mounting pole				
Art. 541-901	680 USD	38	535	26

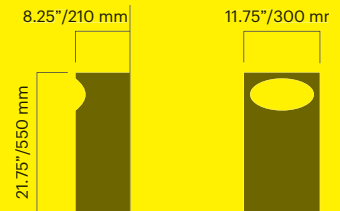

Urban litter receptacle

26 gallons

Wall-mounted		kg CO ₂ e	MJ	lbs
Art. 546-900	1 470 USD	120	1 680	100
Wall-mounted				
Art. 546-901	1 210 USD	120	1 680	84

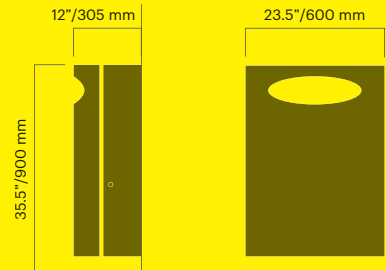

Urban litter receptacle

26 gallons

Art. 542-900	1 680 USD	154	2 240	139
Art. 542-901	1 490 USD	154	2 240	137
With ashtray				
Art. 543-900	2 030 USD	160	2 368	140
Art. 543-901	1 790 USD	160	2 368	140

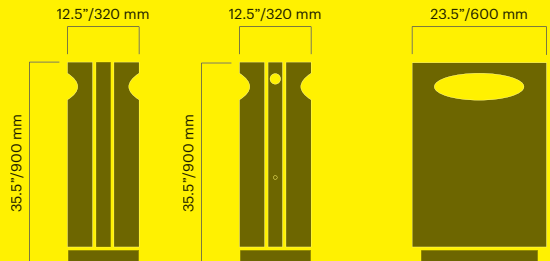

Urban litter receptacle

		kg CO ₂ e	MJ	lbs
Art. 544-900	1 780 USD	183	2 712	179
Art. 544-901	1 580 USD	183	2 712	179

With ashtray

Art. 545-900	2 100 USD	194	2 926	183
Art. 545-901	1 850 USD	194	2 926	183

Recycling 2 x 18 gallons

Art. 547-900	2 290 USD	209	3 067	194
Art. 547-901	1 840 USD	209	3 067	194

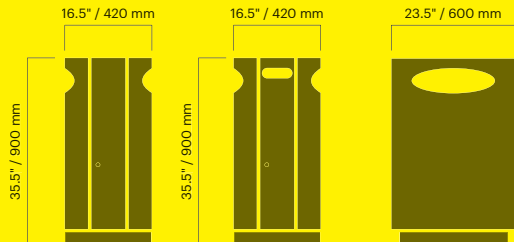

Urban stainless steel collar

		kg CO ₂ e	MJ	lbs
For concrete pedestal 26 gallons				
Art. 542-002	140 USD	8	138	4

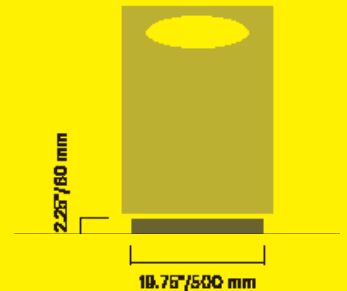

Urban litter receptacle

53 gallons

		kg CO ₂ e	MJ	lbs
Art. 548-900	2 580 USD	248	3 694	251
Art. 548-901	2 280 USD	248	3 694	251

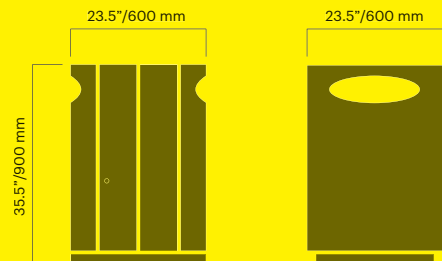

Urban recycling receptacle

3 x 21 gallons

		kg CO ₂ e	MJ	lbs
Art. 572-900	3 450 USD	280	3 913	196
Art. 572-901	3 130 USD	280	3 913	196

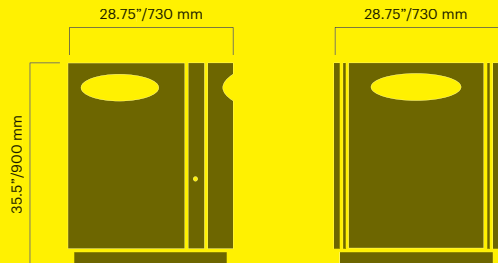

Urban mounting pole

Anchoring A or C		kg CO ₂ e	MJ	lbs
Art. 592-900A	290 USD	54	746	40
Art. 592-901A	270 USD	54	746	40
Art. 593-900C	350 USD	74	746	55
Art. 593-901C	280 USD	54	746	55

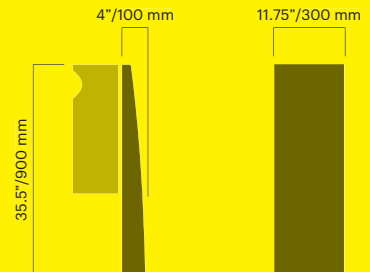

Urban ashtray

1.83 gallons		kg CO ₂ e	MJ	lbs
Wall-mounted				
Art. 560-900	690 USD	37	513	18
Wall-mounted				
Art. 560-901	550 USD	37	513	18

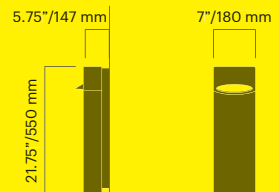

Urban stainless steel collar

For concrete pedestal 37
gallons

		kg CO ₂ e	MJ	lbs
Art. 544-002	150 USD	8	138	4

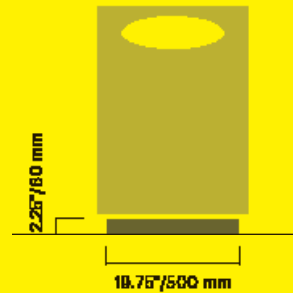

Urban bike bollard

For 2 bikes

Anchoring A or C		kg CO ₂ e	MJ	lbs
Art. 586-900A	310 USD	34	470	24
Art. 586-901A	270 USD	34	470	24
Art. 586-900C	270 USD	31	437	22
Art. 586-901C	250 USD	31	437	22
With LED lighting				
Art. 586-900A-LED	810 USD	36	496	24
Art. 586-900C-LED	790 USD	34	468	24
Art. 586-901A-LED	740 USD	36	496	24
Art. 586-901C-LED	710 USD	34	468	24
Demountable				
Art. 586-900D	740 USD	46	646	24
Art. 586-901D	680 USD	46	646	24

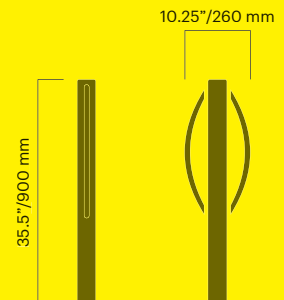

Urban tree barrier

For anchoring		kg CO ₂ e	MJ	lbs
Art. 558-900	1 230 USD	148	2 065	103
Art. 558-901	1 050 USD	148	2 065	103
Ground fixing set				
Art. 559-901	300 USD	22	314	15

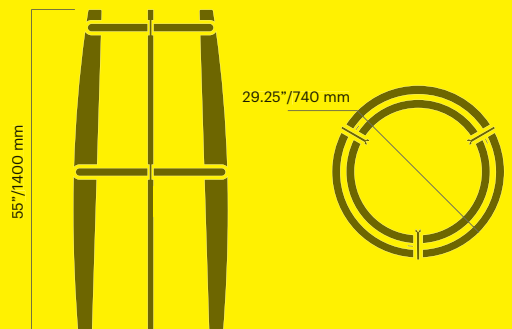

Urban tree grille

1200 x 1200

Art. 565-900	1 480 USD	272	3 800	194
Art. 565-901	1 210 USD	272	3 800	190

D1380

Art. 565-900R	1 480 USD	260	3 623	210
Art. 565-901R	1 210 USD	260	3 623	210

Other patterns and sizes available on request.

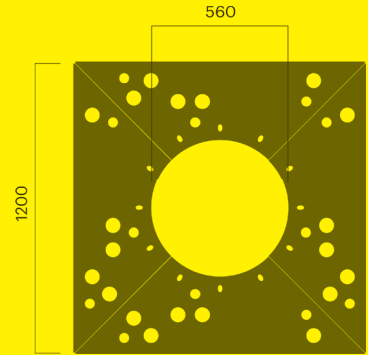

Urban bollard D 76

Anchoring A or C

		kg CO ₂ e	MJ	lbs
Art. 585-900A	240 USD	27	371	19
Art. 585-901A	190 USD	27	371	19
Art. 585-900C	190 USD	22	305	15
Art. 585-901C	170 USD	27	371	15

Demountable

Art. 585-900D	350 USD	28	395	20
Art. 585-901D	330 USD	28	395	20

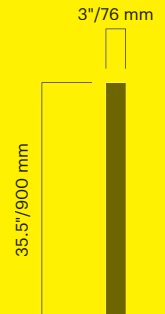

Urban bollard D 127

Anchoring A or C

		kg CO ₂ e	MJ	lbs
Art. 588-900A	420 USD	60	831	42
Art. 588-901A	410 USD	60	831	42
Art. 588-900C	420 USD	54	747	42
Art. 588-901C	360 USD	54	747	42

Demountable

Art. 588-900D	530 USD	60	838	42
Art. 588-901D	470 USD	60	838	42

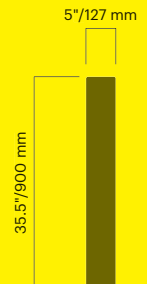

Urban bollard

With chain or rope fastener

Anchoring A or C		kg CO ₂ e	MJ	lbs
Art. 584-900A	340 USD	27	376	22
Art. 584-901A	320 USD	27	376	22
Art. 584-900C	330 USD	29	400	22
Art. 584-901C	300 USD	29	400	22
Demountable				
Art. 584-900D	360 USD	30	422	22
Art. 584-901D	340 USD	30	422	22

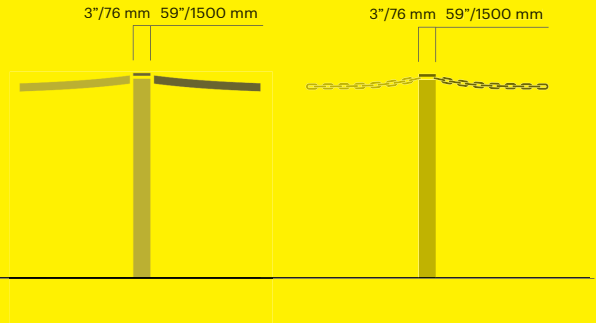

Urban bollard

Chain 39"		kg CO ₂ e	MJ	lbs
Art. 590-900	60 USD	6	88	4
Art. 590-901	40 USD	6	88	4
Hemp rope 59"				
Art. 582-900	270 USD	9	186	9
Art. 582-901	250 USD	9	186	9
Bird stopper for Urban litter receptacle				
Art. 574-902	340 USD	4	67	4

Vega

Vega bike bollard

For 2 bikes

Powder-coated aluminium		kg CO ₂ e	MJ	lbs
Art. 3996-904C	610 USD	247	2 502	24

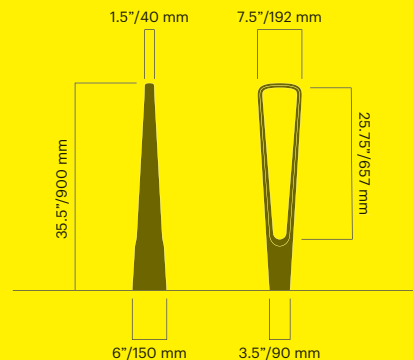

Vestre Habitats



Vestre Habitats insect hotel

Anchoring A or C		kg CO ₂ e	MJ	lbs
Art. 5903-900A	490 USD	40	558	35
Art. 5903-901A	360 USD	40	558	35
Art. 5903-900C	450 USD	41	577	35
Art. 5903-901C	330 USD	41	577	35

Options for fronts and inner structures, Perforated steel front and back

Art. 5904-900	390 USD	7	103	6
Art. 5904-901	290 USD	7	103	7

Wood front and back

Art. 5906-811	340 USD	1	23	5
---------------	----------------	---	----	---

Bumblebee house in wood

Art. 5907-811	290 USD	1	23	5
---------------	----------------	---	----	---

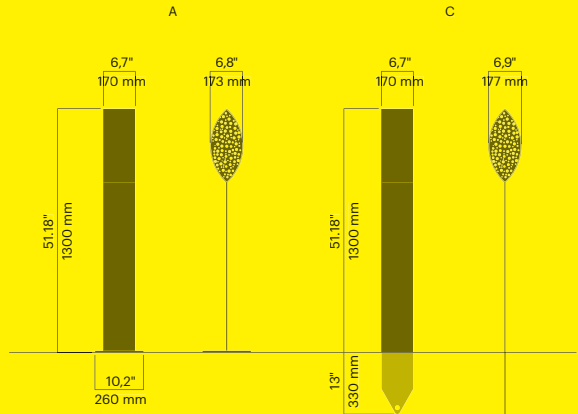

Vestre Habitats insect hotel double

Anchoring A or C		kg CO ₂ e	MJ	lbs
Art. 5905-900A	730 USD	62	864	44
Art. 5905-901A	600 USD	62	864	44
Art. 5905-900C	800 USD	80	1119	57
Art. 5905-901C	680 USD	80	1119	57

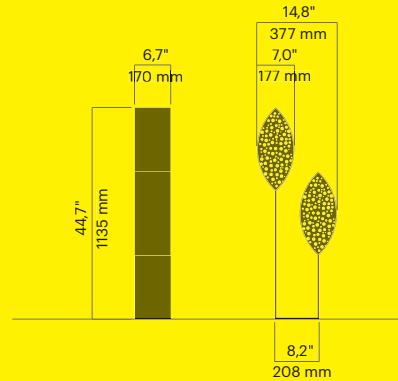

Vestre Habitats

Combination with 3 bird houses in different sizes and integrated insect hotel

		kg CO ₂ e	MJ	lbs
Art. 5823-900C	3 360 USD	140	2 166	101
Art. 5823-901C	3 200 USD	140	2 166	101
Wide bird house				
Art. 5824-904	970 USD	46	771	24
Narrow bird house				
Art. 5825-904	1 060 USD	23	374	22
Bird and insect house				
Art. 5826-904	1 060 USD	23	381	15

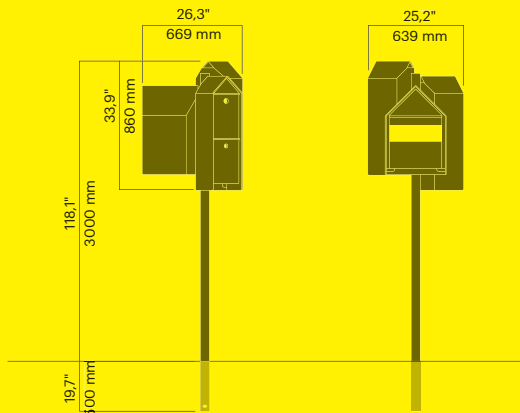

Vestre Habitats

6.5" mounting pole anchoring A or C

		kg CO ₂ e	MJ	lbs
Art. 5827-900A	330 USD	188	2 612	29
Art. 5827-901A	260 USD	188	2 612	29
Art. 5827-900C	300 USD	42	589	29
Art. 5827-901C	240 USD	42	589	29

9.8" mounting pole anchoring A or C

Art. 5828-900A	360 USD	204	2 838	40
Art. 5828-901A	290 USD	204	2 838	40
Art. 5828-900C	340 USD	59	831	40
Art. 5828-901C	270 USD	59	831	40

Large footplate D700 for 78.7" mounting pole

Art. 5829-900	600 USD	151	2 109	106
Art. 5829-901	510 USD	151	2 109	106

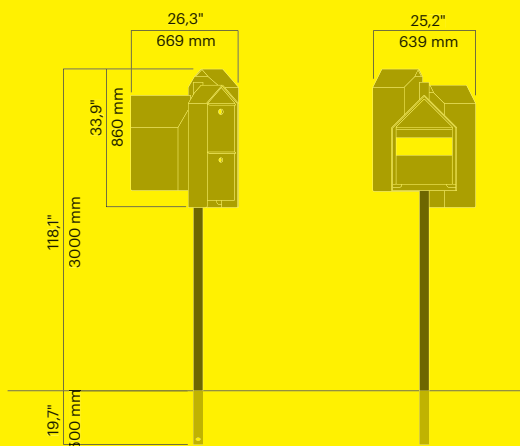

Vestre Habitats compost and plant box

Square H15.7"

		kg CO ₂ e	MJ	lbs
Art. 5880-900	2 310 USD	246	3 432	258
Art. 5880-901	2 160 USD	246	3 432	258
Art. 5880-903	2 310 USD	246	3 432	258

Square H39.4"

Art. 5884-900	4 490 USD	615	8 580	617
Art. 5884-901	3 860 USD	615	8 580	617
Art. 5884-903	4 490 USD	615	8 580	617

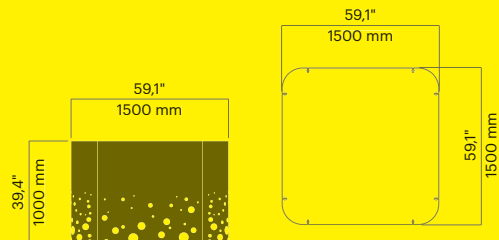

Decay Edge compost and planter

Circle

		kg CO ₂ e	MJ	lbs
Art. 5874-900	2 730 USD	571	7 958	412
Art. 5874-901	2 230 USD	571	7 958	412
Art. 5874-903	2 730 USD	573	3 870	412

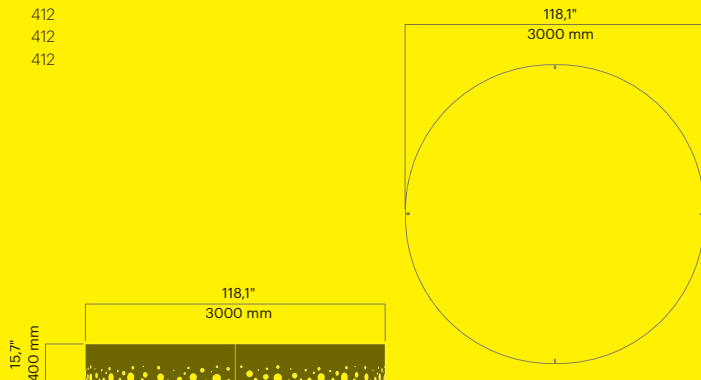

Vestre Habitats modules

H15.7"

Straight side L39.4"

		kg CO ₂ e	MJ	lbs
Art. 5850-900	410 USD	62	861	44
Art. 5850-901	340 USD	62	861	44

Straight side L78.7"

Art. 5852-900	710 USD	95	1 371	82
Art. 5852-901	580 USD	95	1 371	82

Small 90° radius corner R7.9"

Art. 5854-900	250 USD	28	388	1133
Art. 5854-901	190 USD	28	388	1133

Large 90° radius corner R57.8"

Art. 5858-900	730 USD	143	1 995	101
Art. 5858-901	600 USD	143	1 995	101

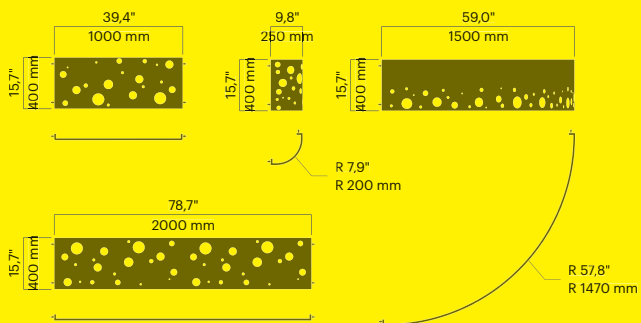

Vestre Habitats modules

H39.4"

Straight side L39.4"

		kg CO ₂ e	MJ	lbs
Art. 5860-900	740 USD	162	2 255	115
Art. 5860-901	610 USD	162	2 255	115

Straight side L78.7"

Art. 5862-900	1 430 USD	310	4 322	223
Art. 5862-901	1 200 USD	310	4 322	223

Small 90° radius corner R7.9"

Art. 5864-900	440 USD	74	1 028	53
Art. 5864-901	350 USD	74	1 028	53

Large 90° radius corner R57.8"

Art. 5868-900	1 730 USD	370	5 156	265
Art. 5868-901	1 480 USD	370	5 156	265

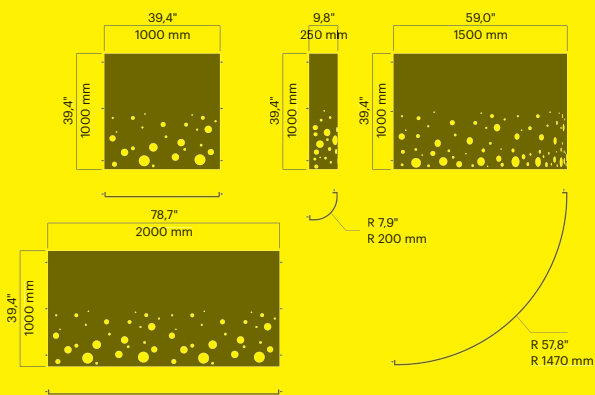

Vestre Habitats backless bench for logs

Anchoring A or C

		kg CO ₂ e	MJ	lbs
Art. 5803-900A	2 190 USD	317	4 572	251
Art. 5803-901A	1 940 USD	317	4 572	251
Art. 5803-900C	2 310 USD	345	4 974	251
Art. 5803-901C	2 080 USD	345	4 974	251

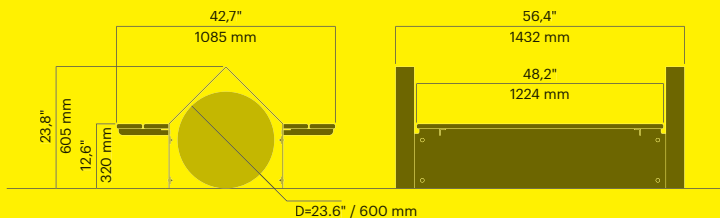

Vestre Habitats backed bench for stones / organic waste

Anchoring A or C

		kg CO ₂ e	MJ	lbs
Art. 5813-900A	2 230 USD	237	3 453	171
Art. 5813-901A	1 950 USD	237	3 453	172
Art. 5813-900C	2 350 USD	251	3 652	181
Art. 5813-901C	2 090 USD	251	3 652	181

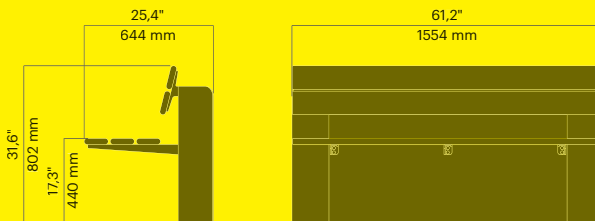

Via



Via complete backless bench straight

Free-standing or wall mounted (B)

		kg CO ₂ e	MJ	lbs
Art. 1306-900B	1 980 USD	129	2 096	167
Art. 1306-901B	1 900 USD	129	2 096	167
Art. 1306-900	2 050 USD	101	2 475	187
Art. 1306-901	1 850 USD	101	2 096	187

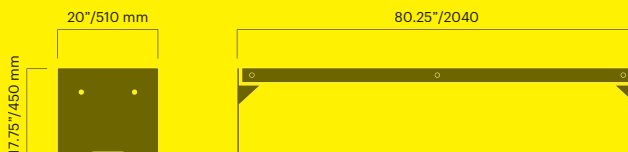

Via backless bench top straight

		kg CO ₂ e	MJ	lbs
Art. 1320-900	1 400 USD	42	1 273	105
Art. 1320-901	1 350 USD	42	1 273	105
For wall top				
Art. 1320-900MK	1 330 USD	40	1 249	104
Art. 1320-901MK	1 310 USD	40	1 249	104

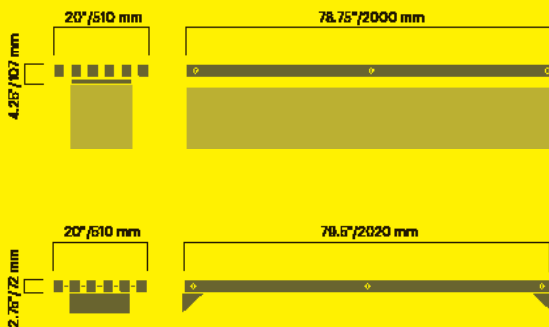

Via complete backless bench curved

Free-standing or wall mounted (B)		kg CO ₂ e	MJ	lbs
Art. 1308-900	2 970 USD	217	3 647	219
Art. 1308-901	2 740 USD	217	3 647	219
Art. 1308-900B	3 050 USD	166	2 929	183
Art. 1308-901B	2 790 USD	166	2 929	183

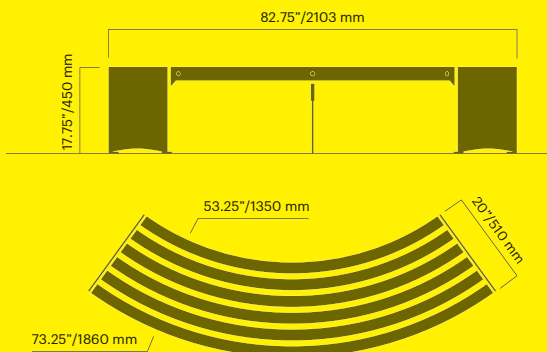

Via circle backless bench

		kg CO ₂ e	MJ	lbs
Art. 1310-900	11 610 USD	496	10 009	890
Art. 1310-901	10 420 USD	496	10 009	890

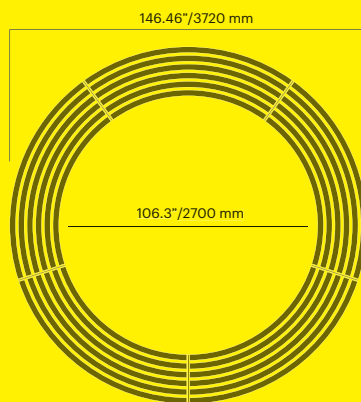

Via backless bench top curved

		kg CO ₂ e	MJ	lbs
Art. 1330-900	2 340 USD	99	2 001	137
Art. 1330-901	2 180 USD	99	2 001	137

For wall top

Art. 1330-900MK	1 980 USD	64	1 549	101
Art. 1330-901MK	1 930 USD	64	1 549	101

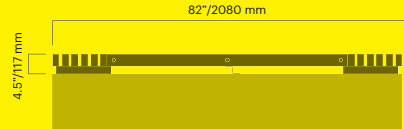
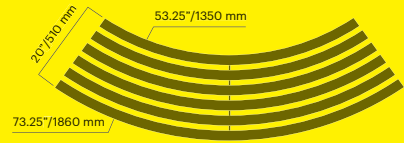

Via connector

Connector or end piece		kg CO ₂ e	MJ	lbs
Art. 1350-900	330 USD	59	823	41
Art. 1350-901	300 USD	59	823	41

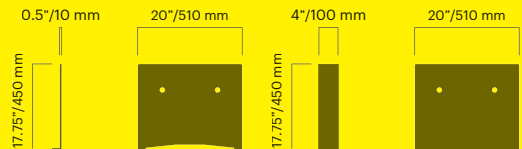

Via double connector

		kg CO ₂ e	MJ	lbs
Art. 1352-900	520 USD	136	1 888	77
Art. 1352-901	470 USD	136	1 888	77

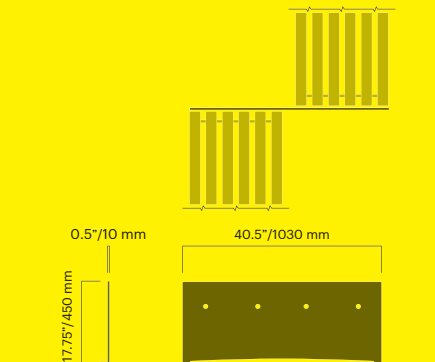

Via backrest and armrest

Backrest		kg CO ₂ e	MJ	lbs
Art. 1327-900	730 USD	12	190	11
Art. 1327-901	670 USD	12	190	11
Armrest		kg CO ₂ e	MJ	lbs
Art. 1325-900	280 USD	13	185	9
Art. 1325-901	250 USD	13	185	9

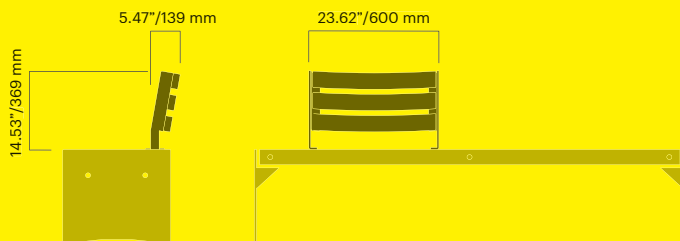

Via table

Via table		kg CO ₂ e	MJ	lbs
Art. 1336-900	2 630 USD	242	4 286	247
Art. 1336-901	2 430 USD	242	4 286	247

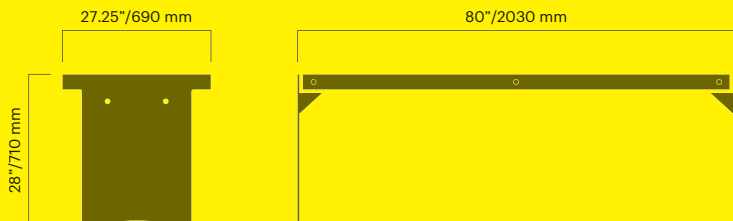

Via table curved

Via table curved		kg CO ₂ e	MJ	lbs
Art. 1338-900	1 850 USD	210	3 330	192
Art. 1338-901	1 700 USD	210	3 330	192

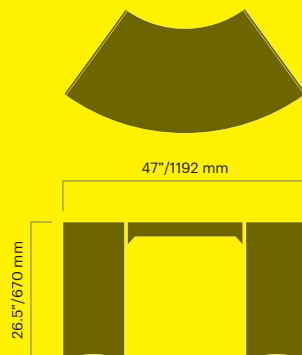

Via planter

45 gallons

Low		kg CO ₂ e	MJ	lbs
Art. 1381-900	1 980 USD	359	4 997	251
Art. 1381-901	1 740 USD	359	4 997	251
High		kg CO ₂ e	MJ	lbs
Art. 1384-900	2 810 USD	639	8 892	447
Art. 1384-901	2 480 USD	639	8 892	447

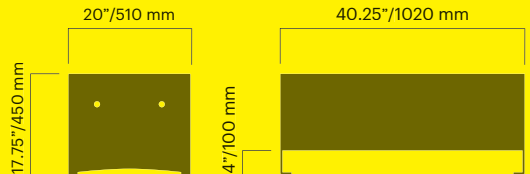

Vroom



Vroom backless bench straight end

		kg CO ₂ e	MJ	lbs
Art. 607-900	1 160 USD	148	2 298	129
Art. 607-901	1 050 USD	148	2 298	129

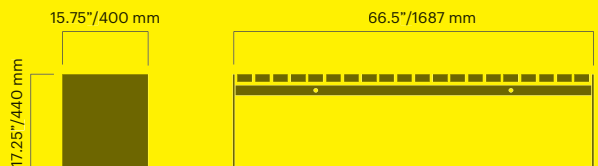

Vroom backed bench straight end

		kg CO ₂ e	MJ	lbs
Art. 617-900	1 850 USD	190	2 892	198
Art. 617-901	1 660 USD	190	2 892	197

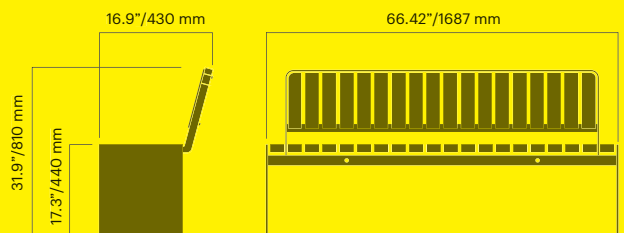

Vroom backless bench curved end

		kg CO ₂ e	MJ	lbs
Art. 606-900	1 510 USD	190	2 885	159
Art. 606-901	1 330 USD	190	2 885	159

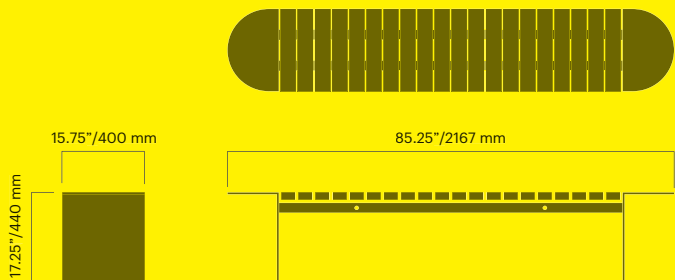

Vroom backed bench curved end

		kg CO ₂ e	MJ	lbs
Art. 616-900	2 120 USD	239	3 873	227
Art. 616-901	1 860 USD	239	3 873	226

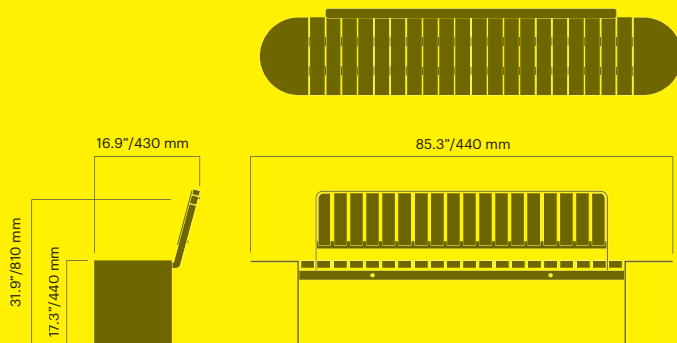

Vroom 600 backless bench

		kg CO ₂ e	MJ	lbs
Art. 609-900	1 990 USD	212	3 391	196
Art. 609-901	1 740 USD	212	3 391	196

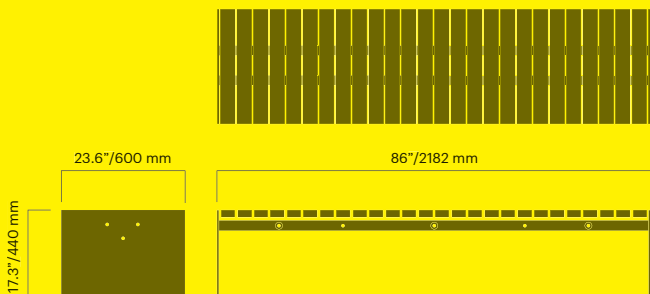

Vroom 1200 backless bench

		kg CO ₂ e	MJ	lbs
Art. 612-900	3 490 USD	369	6 022	354
Art. 612-901	3 200 USD	369	6 022	354

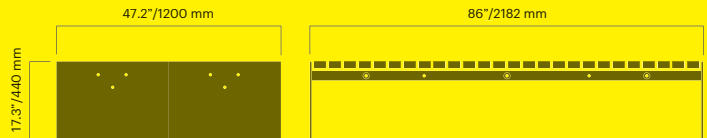
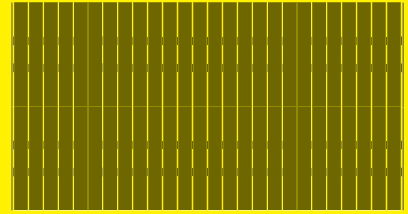

Vroom backless bench top

		kg CO ₂ e	MJ	lbs
Short				
Art. 620-900JR	550 USD	35	623	40
Art. 620-901JR	510 USD	35	623	40
Standard				
Art. 620-900	700 USD	54	994	64
Art. 620-901	640 USD	54	994	64
Long				
Art. 632-900	1 240 USD	73	1 457	99
Art. 632-901	1 160 USD	73	1 457	99

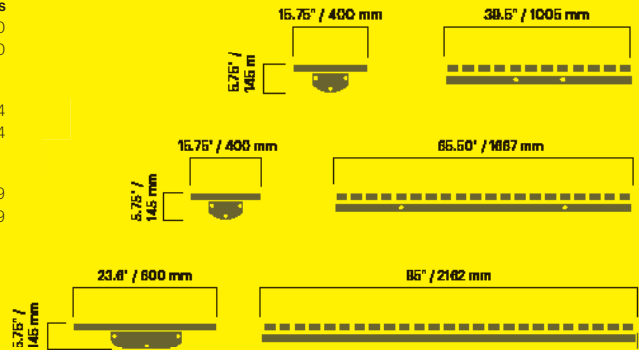

Vroom backless bench top for wall

		kg CO ₂ e	MJ	lbs
H3.4\" for wall top				
Art. 620-900MK	870 USD	59	1 066	67
Art. 620-901MK	810 USD	59	1 066	68
H55 MKL1 = 38,9\"; MKL2 = 65,6\"; MKL3 = 78,1\"				
Art. 620-901MKL1	340 USD	18	357	29
Art. 620-901MKL2	550 USD	29	638	46
Art. 620-901MKL3	680 USD	38	806	57

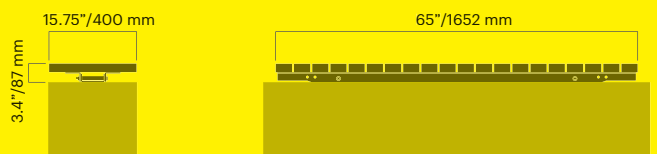

Vroom backrest for benches of all widths

		kg CO ₂ e	MJ	lbs
Art. 629-900	710 USD	51	1 010	68
Art. 629-901	550 USD	51	1 010	68

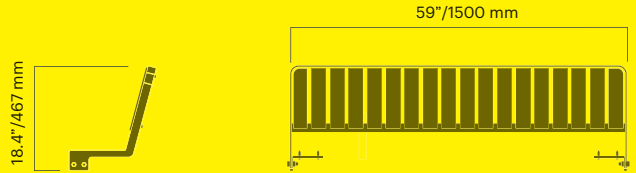

Vroom curved worktop

D2000		kg CO ₂ e	MJ	lbs
Art. 630-900-D2	860 USD	47	796	49
Art. 630-901-D2	790 USD	47	796	49

D3000		kg CO ₂ e	MJ	lbs
Art. 630-900-D3	860 USD	51	853	51
Art. 630-901-D3	790 USD	51	853	51

D4000		kg CO ₂ e	MJ	lbs
Art. 630-900-D4	860 USD	52	871	52
Art. 630-901-D4	790 USD	51	853	52

D5000		kg CO ₂ e	MJ	lbs
Art. 630-900-D5	860 USD	54	899	54
Art. 630-901-D5	790 USD	52	871	54

For wall top				
Art. 630-900MK	850 USD	54	899	43
Art. 630-901MK	810 USD	54	899	42
Art. 630-901MKL	810 USD	54	899	31

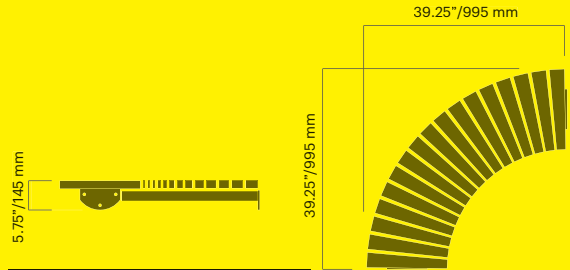

Vroom circle backless bench

D2000 (4 bench tops and legs)		kg CO ₂ e	MJ	lbs
Art. 610-900-D2	4 210 USD	373	5 782	324
Art. 610-901-D2	3 930 USD	373	5 782	324

D3000 (6 bench tops and legs)		kg CO ₂ e	MJ	lbs
Art. 610-900-D3	6 800 USD	585	9 018	503
Art. 610-901-D3	6 330 USD	585	9 018	502

D4000 (8 bench tops and legs)		kg CO ₂ e	MJ	lbs
Art. 610-900-D4	9 140 USD	793	12 202	678
Art. 610-901-D4	8 430 USD	793	12 202	978

D5000 (10 bench tops and legs)		kg CO ₂ e	MJ	lbs
Art. 610-900-D5	11 610 USD	1003	15 511	866
Art. 610-901-D5	10 780 USD	1003	15 511	866

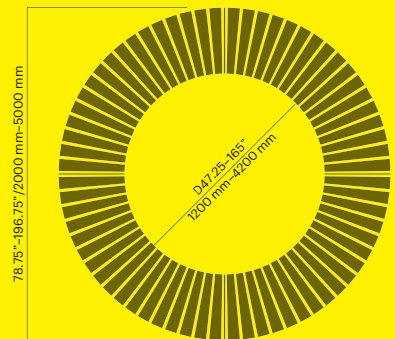

Vroom leg/connector

		kg CO ₂ e	MJ	lbs
Art. 650-900	270 USD	46	641	32
Art. 650-901	210 USD	46	641	32
Art. 650-900C	300 USD	46	641	44
Art. 650-901C	270 USD	46	641	44

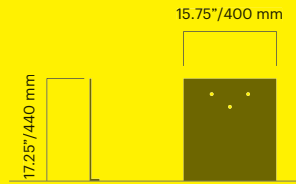

Vroom 600 leg/connector

		kg CO ₂ e	MJ	lbs
Art. 673-900	360 USD	69	960	49
Art. 673-901	320 USD	69	960	48

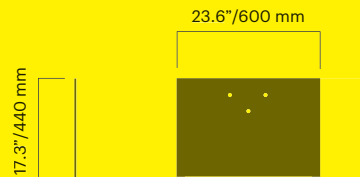

Vroom 1200 leg/connector

		kg CO ₂ e	MJ	lbs
Art. 675-900	560 USD	110	1513	78
Art. 675-901	450 USD	110	1513	77

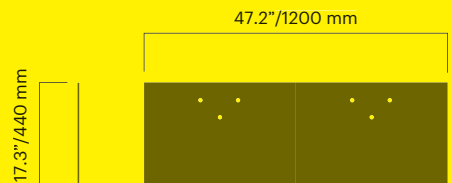

Vroom the armrests

Armrest		kg CO ₂ e	MJ	lbs
Art. 624-900	200 USD	8	108	6
Art. 624-901	150 USD	8	108	8

For bench on wall top

Art. 624-900MK	210 USD	8	108	12
Art. 624-901MK	150 USD	8	108	12

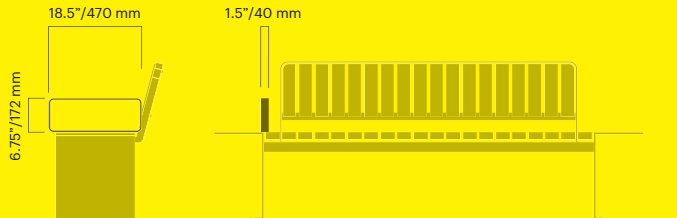

Vroom curved end piece

		kg CO ₂ e	MJ	lbs
Art. 651-900	400 USD	68	941	47
Art. 651-901	340 USD	68	941	47

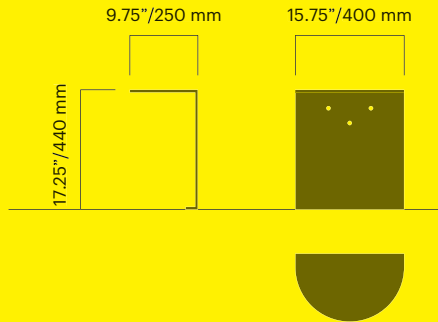

Vroom wall mount

Left		kg CO ₂ e	MJ	lbs
Art. 658-900V	250 USD	35	489	25
Art. 658-901V	190 USD	35	489	25

Mid

Art. 658-900M	330 USD	35	489	25
Art. 658-901M	290 USD	35	489	25

Right

Art. 658-900H	250 USD	35	489	25
Art. 658-901H	190 USD	35	489	25

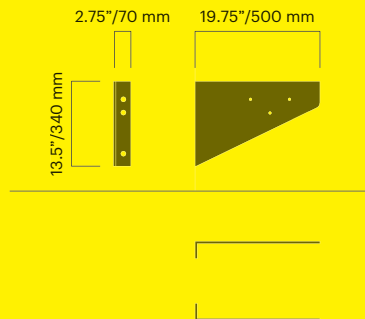

Vroom 15° angle

		kg CO ₂ e	MJ	lbs
Art. 666-900	740 USD	127	1775	89
Art. 666-901	610 USD	127	1775	82

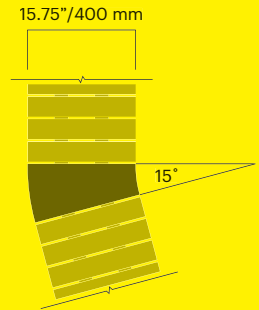

Vroom 30° angle

		kg CO ₂ e	MJ	lbs
Art. 661-900	770 USD	124	1733	87
Art. 661-901	670 USD	124	1733	87

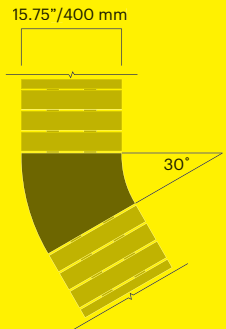

Vroom 45° angle

		kg CO ₂ e	MJ	lbs
Art. 662-900	800 USD	133	1850	93
Art. 662-901	730 USD	133	1850	93

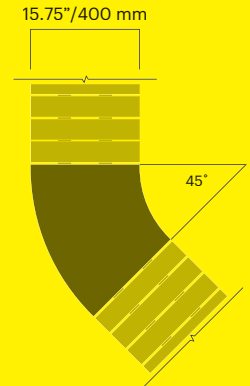

Vroom 60° angle

		kg CO ₂ e	MJ	lbs
Art. 663-900	820 USD	135	1 882	94
Art. 663-901	740 USD	135	1 882	94

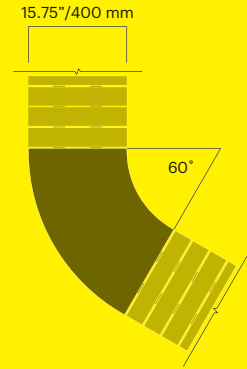

Vroom 90° angle

		kg CO ₂ e	MJ	lbs
Art. 664-900	860 USD	141	1 972	99
Art. 664-901	770 USD	141	1 972	99

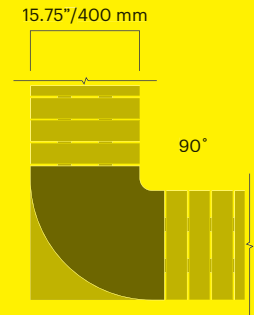

Vroom 120° angle

		kg CO ₂ e	MJ	lbs
Art. 665-900	900 USD	161	2 249	111
Art. 665-901	800 USD	161	2 249	111

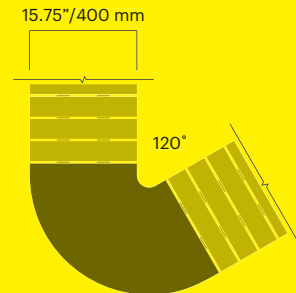

Vroom curved back internal radius

		kg CO ₂ e	MJ	lbs
IR600				
Art. 622-900-D2	940 USD	30	465	24
Art. 622-901-D2	810 USD	30	465	24
IR100				
Art. 622-900-D3	940 USD	33	505	49
Art. 622-901-D3	810 USD	33	505	49
IR1600				
Art. 622-900-D4	940 USD	35	548	51
Art. 622-901-D4	810 USD	35	548	51
IR2100				
Art. 622-900-D5	940 USD	37	575	55
Art. 622-901-D5	810 USD	37	575	55

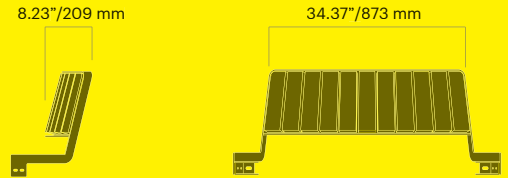

Vroom curved back external radius

		kg CO ₂ e	MJ	lbs
ER1000				
Art. 623-900-D2	1 230 USD	46	721	75
Art. 623-901-D2	1 060 USD	46	721	75
ER1500				
Art. 623-900-D3	1 230 USD	49	912	73
Art. 623-901-D3	1 060 USD	49	912	73
ER2000				
Art. 623-900-D4	1 230 USD	44	688	68
Art. 623-901-D4	1 060 USD	44	688	68
ER2500				
Art. 623-900-D5	1 230 USD	44	688	68
Art. 623-901-D5	1 060 USD	44	688	68

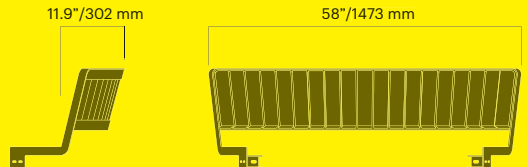

Vroom table for backless bench

		kg CO ₂ e	MJ	lbs
Bench 400				
Art. 638-900	420 USD	30	416	21
Art. 638-901	370 USD	30	416	21
Bench 600				
Art. 639-900	420 USD	32	444	21
Art. 639-901	370 USD	32	444	21

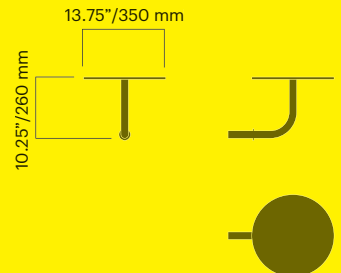

Vroom narrow table

		kg CO ₂ e	MJ	lbs
Art. 635-900	1 680 USD	214	3 344	189
Art. 635-901	1 490 USD	214	3 344	189

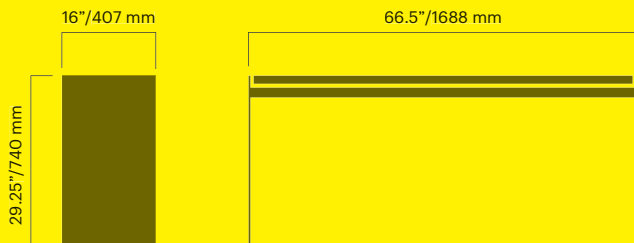

Vroom table

		kg CO ₂ e	MJ	lbs
Art. 636-900	1 750 USD	215	3 642	222
Art. 636-901	1 490 USD	215	3 642	222

Add-on module

Art. 640-900	1 400 USD	136	2 544	154
Art. 640-901	1 160 USD	136	2 544	154

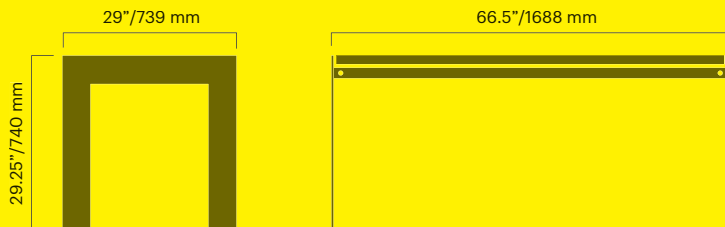

Vroom square table

		kg CO ₂ e	MJ	lbs
Art. 637-900	3 100 USD	340	5 309	286
Art. 637-901	2 810 USD	340	5 309	286

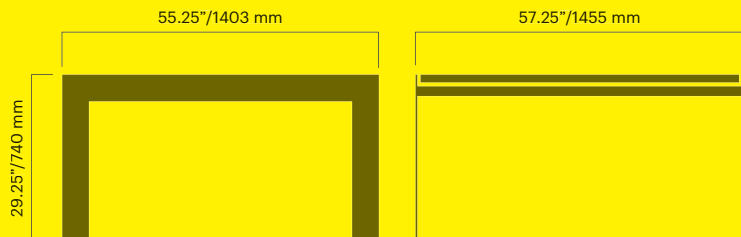

Vroom litter receptacle

21 gallons

		kg CO ₂ e	MJ	lbs
Art. 642-900	2 000 USD	295	4 106	205
Art. 642-901	1 680 USD	295	4 106	205

Corrugated front and back

Art. 642-900R	2 080 USD	285	3 982	201
Art. 642-901R	1 740 USD	285	3 982	201

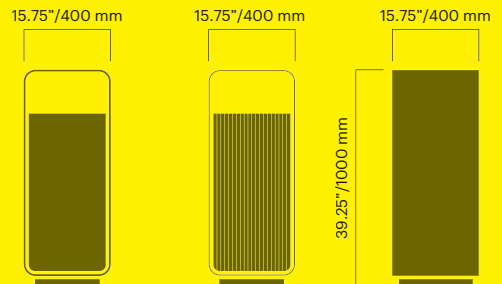

Vroom litter receptacle

37 gallons

		kg CO ₂ e	MJ	lbs
Art. 644-900	2 120 USD	285	3 982	278
Art. 644-901	1 990 USD	285	3 982	278

Corrugated front and back

Art. 644-900R	2 280 USD	396	5 514	265
Art. 644-901R	2 050 USD	396	5 514	265

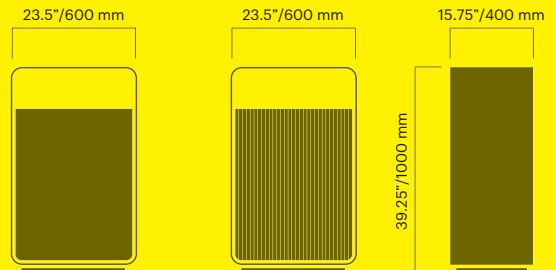

Vroom planter - T10 mm

13 gallons

Small		kg CO ₂ e	MJ	lbs
Art. 681-900	1 120 USD	204	2 848	142
Art. 681-901	950 USD	204	2 848	142

Large

Art. 684-900	2 320 USD	533	7 428	372
Art. 684-901	1 995 USD	533	7 428	372

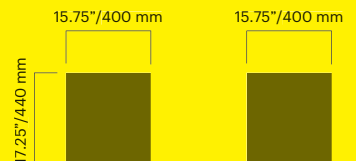

Vroom bike rack

For 2 bikes

Small, powder-coated aluminium

		kg CO ₂ e	MJ	lbs
Art. 686-904A	260 USD	19	319	14
Art. 686-904C	240 USD	21	361	15

Large, powder-coated aluminium

Art. 696-904A	440 USD	30	503	21
Art. 696-904C	300 USD	25	418	21

A-bicycle rack

Art. 694-904A	450 USD	37	615	26
Art. 694-904C	320 USD	31	514	26

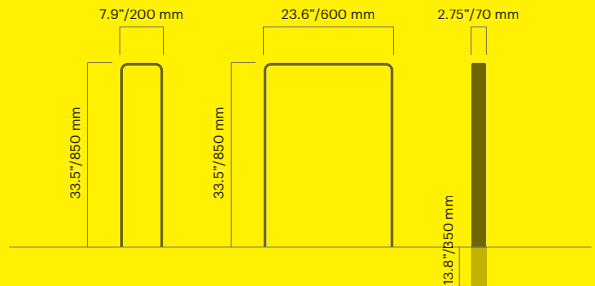

Vroom bike rack

Free-standing rack for 8 bikes

		kg CO ₂ e	MJ	lbs
Art. 688-900	1 980 USD	250	3 695	178

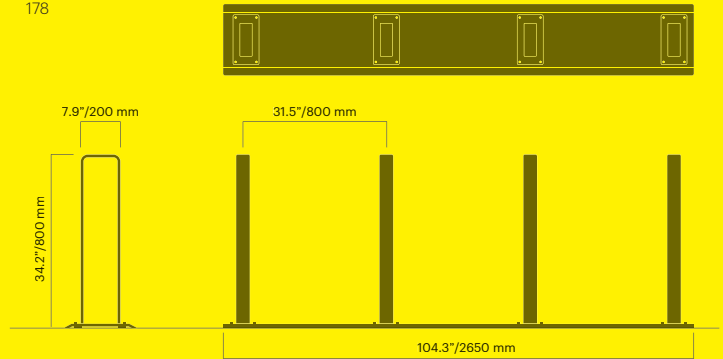

Ypsilon



Ypsilon backless bench

Free-standing or anchoring C

		kg CO ₂ e	MJ	lbs
Art. 6206-900C	1 460 USD	56	1 057	66
Art. 6206-901C	1 220 USD	56	1 057	66
Art. 6206-900	1 460 USD	52	99	69
Art. 6206-901	1 220 USD	52	99	66

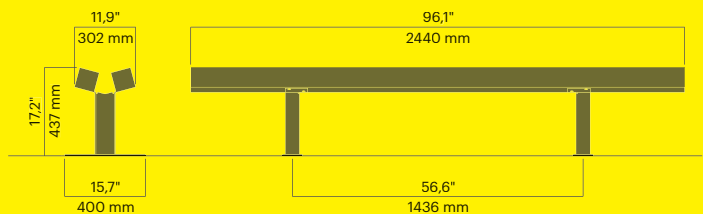

Ypsilon backless bench with armrests

Free-standing or anchoring C	kg CO ₂ e	MJ	lbs	
Art. 6207-900C	1 730 USD	73	1 297	82
Art. 6207-901C	1 480 USD	73	1 297	82
Art. 6207-900	1 730 USD	64	1 168	78
Art. 6207-901	1 480 USD	64	1 168	78

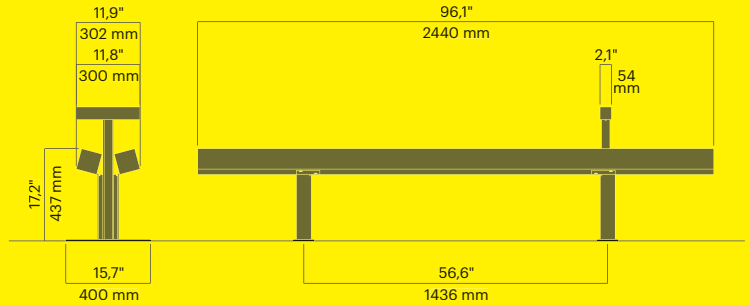

Ypsilon backed bench

Free-standing or anchoring C	kg CO ₂ e	MJ	lbs	
Art. 6216-900C	2 320 USD	153	2 492	130
Art. 6216-901C	2 060 USD	153	2 492	130
Art. 6216-900	2 320 USD	102	1 780	112
Art. 6216-901	2 060 USD	102	1 780	112

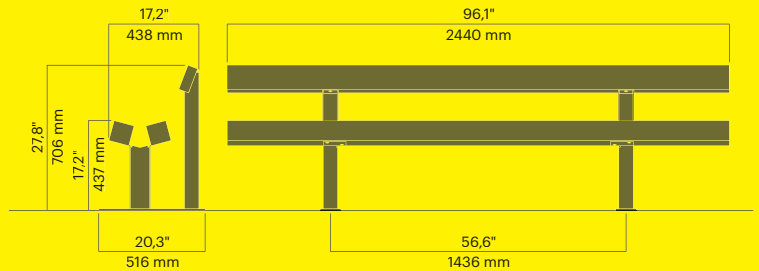

Ypsilon backed bench with armrests

Free-standing or anchoring C	kg CO ₂ e	MJ	lbs	
Art. 6217-900C	2 760 USD	154	2 505	121
Art. 6217-901C	2 510 USD	154	2 505	121
Art. 6217-900	2 760 USD	114	1 949	121
Art. 6217-901	2 510 USD	114	1 949	121

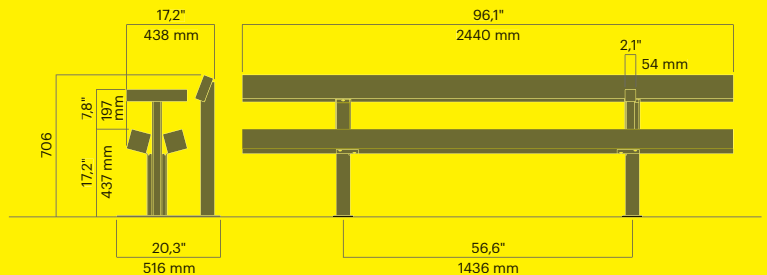

Ypsilon circle stool

D2800		kg CO ₂ e	MJ	lbs
Art. 6210-900C	8 260 USD	-	-	-
Art. 6210-901C	7 690 USD	-	-	-
Art. 6210-900	7 980 USD	-	-	-
Art. 6210-901	7 410 USD	-	-	-
D3500 - Pricing on request				
Art. 6212-900C	-	-	-	-
Art. 6212-901C	-	-	-	-
Art. 6212-900	-	-	-	-
Art. 6212-901	-	-	-	-

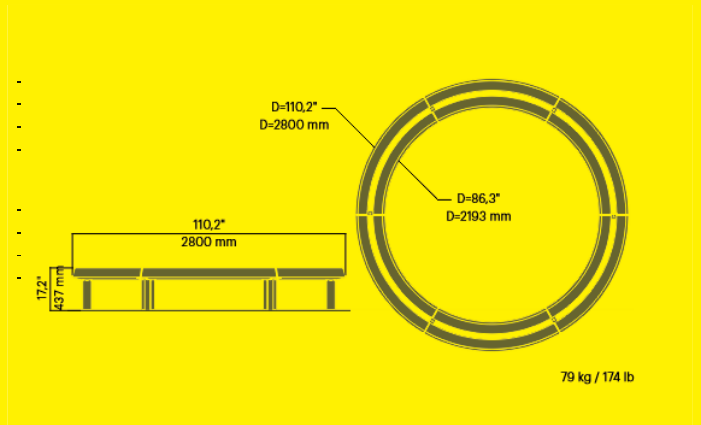

Ypsilon table

		kg CO ₂ e	MJ	lbs
Art. 6238-900	350 USD	12	12	9
Art. 6238-901	290 USD	164	164	9

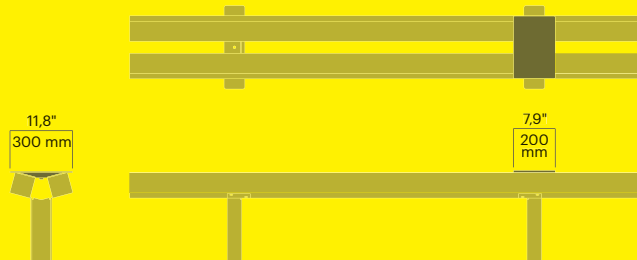



Extra allen key

	kg CO ₂ e	MJ	lbs
Art. 90007-901	15 USD	- 0	0

City concrete foundation

For City litter bins 18 gallons and ashtray 4.5/15 gallons	kg CO ₂ e	MJ	lbs
Art. 267-004	100 USD	6 220	28

For City litter bins 40/47 gallons and large ashtray	kg CO ₂ e	MJ	lbs
Art. 247-004	120 USD	14 496	58

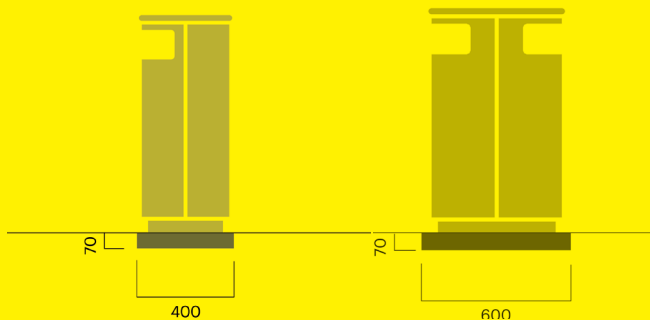

City concrete foundation

Root fixing foundation	kg CO ₂ e	MJ	lbs
Art. 193-004	50 USD	6 212	0

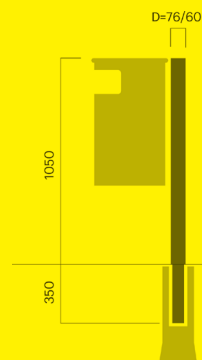

Optional extras for planters

		kg CO ₂ e	MJ	lbs
Art. Antigrafittbehandling	230 USD	-	-	0
Art. Feste for plantestøtte	350 USD	-	-	0

Irrigation system on request. Can be supplied with drainage holes at no extra cost.

City Options

Bird stopper for 13/18 gallons		kg CO ₂ e	MJ	lbs
Art. 201-902	140 USD	11	200	0

Bird stopper for 40/47 gallons

Art. 202-902	260 USD	18	333	2
--------------	---------	----	-----	---

Bloc Options

		kg CO ₂ e	MJ	lbs
Art. 1540-902	360 USD	-	0	2

Power outlet

Universal model for benches		kg CO ₂ e	MJ	lbs
Art. 90004-902	650 USD	9	130	1



Norway

+47 23 00 78 40
post@vestre.com

Sweden

+46 (0)560 688877
info@vestre.com

Denmark

+45 89 88 23 30
post@vestre.com

UK & Ireland

+44 (0)207 846 8725
uk@vestre.com

Germany

+49 (0)30 407 417 95
de@vestre.com

France

+49 (0)30 407 417 95
de@vestre.com

Switzerland

+49 (0)30 407 417 95
de@vestre.com

Benelux

+49 (0)30 407 417 95
de@vestre.com

Austria

+49 (0)30 407 417 95
de@vestre.com

USA

+1 212 634 9658
usa@vestre.com

Global Export

international@vestre.com

Scan for your local
sales representative:

